

DOGHER

TOOLS



2014

Estimad@s Clientes y Amig@s

Tengo el placer de presentarles el nuevo catálogo de Herramienta Manual DOGHER TOOLS 2014, que sin duda es la solución integral más innovadora y competitiva del mercado. DOGHER TOOLS hace converger en una sola gama la oferta más completa y equilibrada para los clientes más exigentes.

DOGHER TOOLS se consolida como la opción más competitiva en el mercado industrial de la Herramienta Manual, ofreciendo a sus clientes las herramientas de mayor calidad, dentro de la amplia gama de referencias que componen cada una de las familias presentadas en el presente catálogo, y siempre con la garantía que aporta una empresa cercana y orientada a ese cliente profesional que necesita ofrecer herramientas de calidad y un servicio Premium; en definitiva una garantía de competitividad en un mercado cada vez mas exigente.

Satisfacer las necesidades de nuestros clientes es nuestro principal objetivo, y este nuevo catálogo de Herramientas Manuales DOGHER TOOLS 2014 es la respuesta a sus consultas e inquietudes. Nuestra propuesta se fundamenta en la confianza que depositan los clientes en nuestra Empresa, y a la que tratamos de corresponder con rapidez de respuesta, flexibilidad y dinamismo, ingredientes fundamentales para alcanzar un nivel de calidad y servicio inigualable para las industrias más exigentes.

DOGHER TOOLS tiene una marcada vocación de servicio, todos los profesionales que formamos parte de esta Empresa nos ponemos a disposición del cliente para ofrecer más que herramientas, soluciones. Con DOGHER TOOLS por fin llega un Servicio Especialista al mercado de Herramienta Manual.

Nuestro departamento de Innovación y Desarrollo, en colaboración con la Oficina Técnica y de Producción, diseña las herramientas de mayor calidad para cada tipo de industria, seleccionando para ello los materiales óptimos para cada uno de los procesos de fabricación. Todo este trabajo junto con el uso de las tecnologías de producción más avanzadas, nos permite ofrecer herramientas de la más alta calidad para los profesionales más exigentes.

DOGHER TOOLS es una referencia en el mercado gracias a un Equipo Humano de Profesionales altamente cualificado, implicado y comprometido, que desde la humildad del esfuerzo y dedicación diarios hace suyos los valores de la organización.

Estas son las ventajas que ofrece una empresa innovadora, ágil y dinámica, que pone a disposición de sus clientes una amplia gama de herramientas, que recoge el guante de tratar de satisfacer las necesidades puntuales de sus clientes, y que propone una solución de alta calidad acompañada de un servicio Premium que permita a nuestros clientes competir con todas las garantías.

Disfrute de este nuevo catálogo de Herramientas Manuales DOGHER TOOLS 2014 y háganos partícipe de sus inquietudes y necesidades; nos comprometemos a transformarlas en soluciones.

DOGHER TOOLS, Calidad Industrial, Máximo Rendimiento.

La Dirección



Dear customers and friends,

I am very pleased to present you the new 2014 DOGHER TOOLS catalogue which certainly is the most competitive and integral solution in the market. DOGHER TOOLS combines into a single range the most exhaustive and balanced offer aimed at the most demanding customers.

DOGHER TOOLS consolidates itself as the most competitive Hand Tools range within the industrial distribution market, offering to its customers the highest quality standards in the wide range of items that composes each of the sections presented in this catalogue. We always preserve the guarantee that can only be offered by a customer-oriented company that works closely together with professionals who need to provide top-quality tools with a premium service: a guarantee of competitiveness in an increasingly demanding market.

Meeting our customers' needs is our primary target and this new DOGHER TOOLS 2014 catalogue is undoubtedly the answer to those needs. Our proposal is based on the trust that our customers put in our Company whose fast response, flexibility and unequalled dynamism are basic ingredients to achieve the highest levels of quality and service for the most demanding industries.

DOGHER TOOLS has a strong commitment to service: all the professionals who are part of this Company provide our customers with more than just Hand Tools: solutions. DOGHER TOOLS has finally brought the Service level of a specialist to the Hand Tools market.

Our Research & Development department, in collaboration with the Technical and Production departments, designs the highest quality tools for each type of industry, thereby selecting the optimal materials for each of the manufacturing processes. This complex and thorough work, together with the use of advanced production technology allows us to offer tools of the best possible quality for the most demanding professionals.

DOGHER TOOLS is a reference in the market thanks to a Team of highly qualified Professionals who are involved, committed, and embrace the organization's values through humility, daily efforts and dedication.

These are the advantages of an innovative, agile and dynamic company, which offers a wide range of solutions to its customers and takes up the challenge of trying to meet their specific needs. We allow our customers to compete with all guarantees by offering them a high quality solution accompanied by a premium service.

Enjoy the new range of DOGHER TOOLS and share with us your needs and concerns: we are committed to transforming them into solutions.

DOGHER TOOLS, industrial quality, maximum performance.

The Managing Director.



Chers clients et amis,

J'ai le plaisir de vous présenter le nouveau catalogue d'Outillage à Main DOGHER TOOLS 2014 qui, sans aucun doute, est la solution globale la plus innovante et compétitive du marché. DOGHER TOOLS fait converger en une seule gamme l'offre la plus complète et équilibrée pour les clients les plus exigeants.

DOGHER TOOLS se consolide comme étant l'option la plus compétitive dans le marché de la fourniture industrielle d'Outillage à Main, offrant à ses clients des outils de la plus haute qualité au sein de la large gamme de références qui composent chacune des familles présentées dans ce catalogue. Notre offre est toujours accompagnée de la garantie qu'apporte une entreprise proche et orientée vers ce client professionnel qui a besoin de fournir des outils de qualité et un service Premium. En résumé: un gage de compétitivité dans un marché toujours plus exigeant.

Répondre aux besoins de nos clients est notre objectif principal et ce nouveau catalogue d'Outillage à Main DOGHER TOOLS 2014 est la réponse à leurs demandes et préoccupations. Notre proposition se base sur la confiance que les clients placent en notre Entreprise, confiance à laquelle nous répondons au mieux avec rapidité, flexibilité et dynamisme, ingrédients fondamentaux pour atteindre un niveau de qualité et de service inégalés pour les industries les plus exigeantes.

DOGHER TOOLS possède une vocation de service forte. Tous les professionnels formant cette entreprise sont à la disposition du client afin de lui offrir plus que des outils: des solutions. Avec DOGHER TOOLS arrive enfin le Service d'un Spécialiste sur le marché de l'Outillage à Main.

Notre département de Recherche & Développement, en collaboration avec le Bureau Technique et de Production, dessine les outils de la plus haute qualité pour chaque type d'industrie, sélectionnant pour cela les matériels optimum pour chacun des processus de fabrication. Tout ce travail, ainsi que l'utilisation des technologies de production les plus avancées, nous permet d'offrir les outils de la meilleure qualité pour les professionnels les plus exigeants.

DOGHER TOOLS est une référence dans le marché grâce à une Equipe de Professionnels hautement qualifiés qui, avec leur implication et leur engagement, et depuis l'humilité de l'effort et du dévouement quotidien, embrassent les valeurs de l'organisation.

Ce sont là les avantages d'une entreprise innovante, agile et dynamique, qui met à la disposition de ses clients une large gamme d'outils, qui relève le défi de répondre aux besoins spécifiques de ses clients, et offre une solution de haute qualité accompagnée d'un service Premium qui permet à ses clients d'être compétitifs en toute confiance.

Profitez de la nouvelle gamme d'outillage à main DOGHER TOOLS 2014 et faites-nous part de vos préoccupations et vos besoins : nous nous engageons à les transformer en solutions.

DOGHER TOOLS, Qualité Industrielle, Rendement Maximum.

La Direction

Proceso de fabricación
Manufacturing process · Processus de Fabrication



Alta Tecnología y Procesos innovadores para Producir Herramientas de Alto Rendimiento con la Mayor Calidad.

State of the Art Technology and Innovating processes to achieve Tooling with the Highest Performance and the Best possible Quality.

Haute Technologie et Processus innovants pour Produire des Outils à Haut Rendement et de la Meilleure Qualité.



El control exhaustivo de los procesos de producción y los rigurosos procedimientos de Control de Calidad permiten producir herramientas con las mayores prestaciones para cada aplicación.

Our exhaustive control of the production process combined with the most rigorous Quality Control procedures allow us to manufacture tools with the best possible features and performance for each use.

Le contrôle exhaustif des processus de production et les rigoureuses procédures de Contrôle de Qualité permettent de fabriquer des outils avec les meilleures prestations en fonction de chaque application.

Calidad, Innovación y Desarrollo
Quality and R&D · Qualité, Innovation et Développement



Servicio de Atención al Cliente • Customer Service • Service Client



Servicio de atención al cliente Ininterrumpido 8:00-19:00

Nonstop Customer Service 8:00-19:00

Service Client Ininterrompu de 08h00 à 19h00

Servicio Premium con el 99,9% de las líneas de pedido servidas en el día

Premium service with 99.9% of items ordered dispatched the same day

Service Premium avec 99,9% des lignes commandées livrées le jour même



000

Almacenaje
Storage · Rangement

9



200

Alicates
Pliers · Pinces

53



300

Destornilladores
Screwdrivers · Tournevis

87



400

Puntas de Atornillar
Screwdriver Bits · Embouts de Vissage

129



450

Llaves
Wrenches · Clés

141



500

Llaves de Vaso
Sockets · Douilles

183



600

Llaves Macho
Key Wrenches · Clés Mâles

255



625

Llaves Dinamométricas
Torque Wrench · Clé Dynamométrique

267



650

Fontanería
Plumbing · Plomberie

275



700

Percusión
Percussion · Percussion

283



775

Medición
Measurement · Mesure

301



800

Corte y Abrasión
Cutting & Abrasion · Coupe et Abrasifs

311



855

Construcción
Construction · Construction

337



900

Herramienta Variada
Varied Tools · Outils Divers

347



EXP

Expositores · *Displays · Présentoirs*

353

Amplia Gama de Expositores e Implantaciones a Su Medida

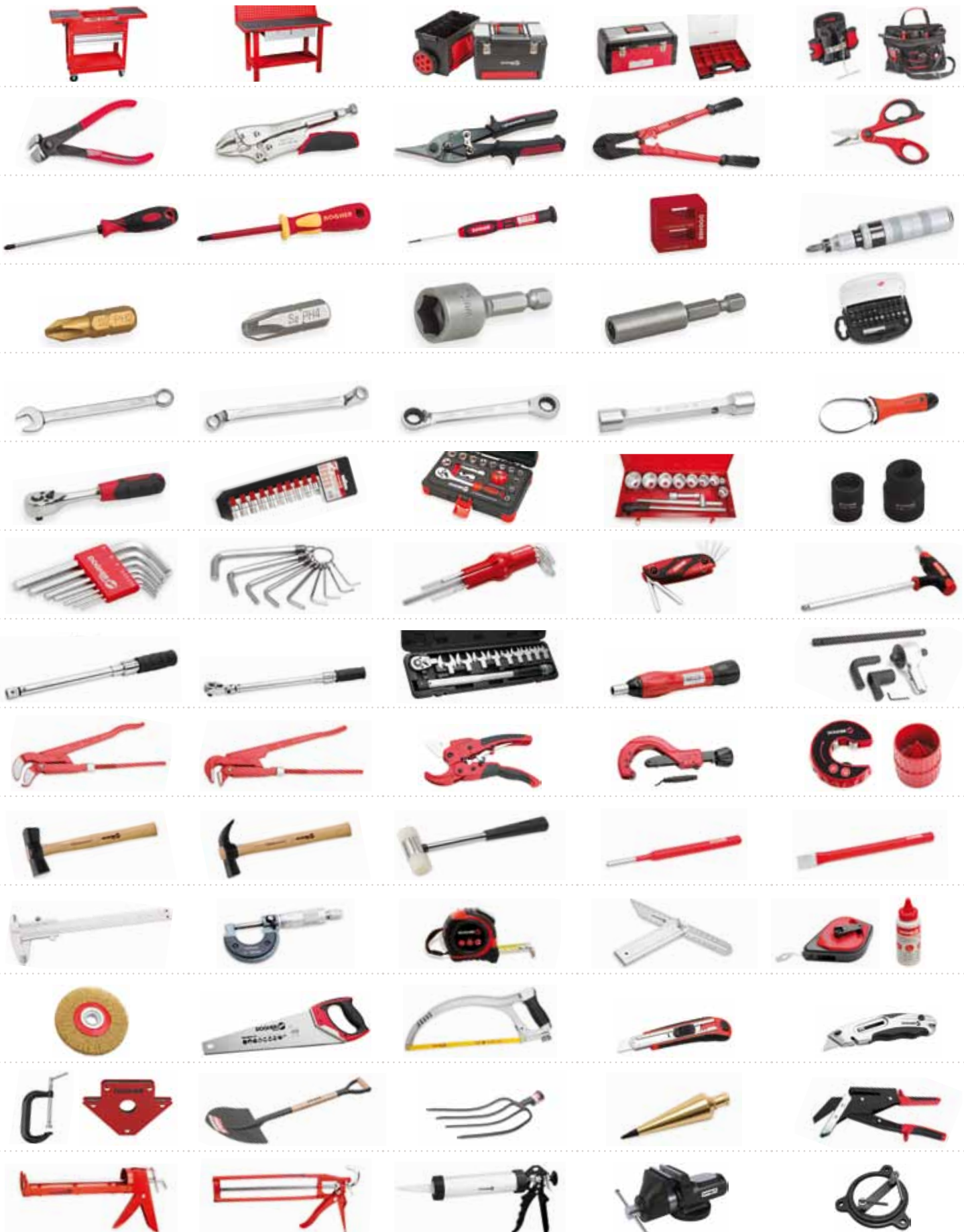



Almacenaje
Storage
Rangement



		12
		16
		18
• 1/4 375 x 140 x 30 mm		20
• 1/2 375 x 280 x 30 mm		26
• 1/3 375 x 188 x 30 mm		27
		32
		33
		34
		37
		45
		48
		
		52
		

Almacenaje • Storage • Rangement

Bandejas Combinables • EVA Foam Trays • Panneaux de Mousse Modulables

Bandejas Combinables para Carros de Taller y Caja Seiton

Metallic Trolleys and Seiton Cases EVA Foam Trays • Panneaux de Mousse Modulables pour Servantes et Caisse Seiton

Seiton

Un lugar para cada herramienta y cada herramienta en su lugar

A place for every tool and every tool in its place

Une place pour chaque outil et chaque outil à sa place

3 **Tamaños de Bandejas para Combinar**

Interchangeable Tray Sizes to be Combined • Tailles de Panneaux Modulables



1/4

• Dimensiones · Dimensions
375 x 140 x 30 mm



1/3

• Dimensiones · Dimensions
375 x 188 x 30 mm



1/2

• Dimensiones · Dimensions
375 x 280 x 30 mm



• **Marcaje Descriptivo para una Rápida Búsqueda**
Descriptive Marking Provides a Quick Search
Marcage Descriptif pour une Recherche Rapide

• **Espuma de Alta Densidad para Fácil Adaptación de la Herramienta**
High Density EVA Foam Provides an Easy Tool Adaptability
Mousse Haute Densité pour un Placement Facilité des Outils

Bandejas Combinables • EVA Foam Trays • Panneaux de Mousse Modulables

Posibles Combinaciones de Bandejas de Espuma para Carros de Taller
Possible Combinations of Metallic Trolleys EVA Foam Trays
Panneaux de Mousse Modulables pour Servantes



Opción • Option **A**



Opción • Option **B**



Opción • Option **C**



Opción • Option **D**



025

Carro Metálico de 3 Cajones con Almacén Inferior

3 Drawer Metallic Trolley with Chest • Servante Métallique 3 Tiroirs et Rangement Inférieur



680 x 458 x 995 mm

- 3 Cajones con Protección de Caucho Antideslizante
Drawers with Anti-Slip Rubber Protection
Tiroirs avec Protection Caoutchouc Anti-glisse
- Almacén Inferior
Bottom Store
Rangement Inférieur

Part N°	€
025-008	702,46

Cargas máximas permitidas:
Max. Load · Charges Max.

- 700 kg Bandeja Superior
Top Floor · Plateau Supérieur
- 35 kg Cajón · Drawer · Tiroir

• Elija Opción · Choose Option · Choisir Votre Option



A
B
C
D

• Dim. Cajón · Dim. Drawer · Dim. Tiroir
570 x 415 mm

025

Carro Metálico de 3 Cajones con Apertura Superior

3 Drawer Metallic Trolley with Top Lid Opening • Servante Métallique 3 Tiroirs et Ouverture Supérieure

- Almacén Superior
Top Store
Rangement Supérieur



690 x 460 x 829 mm

- 3 Cajones con Protección de Caucho Antideslizante
Drawers with Anti-Slip Rubber Protection
Tiroirs avec Protection Caoutchouc Anti-glisse

Part N°	€
025-004	783,81

Cargas máximas permitidas:
Max. Load · Charges Max.

- 400 kg Bandeja Superior
Top Floor · Plateau Supérieur
- 35 kg Cajón · Drawer · Tiroir

• Elija Opción · Choose Option · Choisir Votre Option



A
B
C
D

• Dim. Cajón · Dim. Drawer · Dim. Tiroir
578 x 425 mm

Carros Taller para Bandejas Combinables • Trolleys for EVA Foams • Servantes pour Panneaux de Mousse Modulables

025

Carro Metálico de 7 Cajones con Panel Vertical Portaherramientas Opcional

7 Drawer Metallic Trolley with Optional Tool-Keeper Board • Servante Métallique 7 Tiroirs et Panneau Porte-Outils Vertical Optionnel



680 x 458 x 995 mm

Cargas máximas permitidas:
Max. Load · Charges Max.

- 700 kg Bandeja Superior
Top Floor · Plateau Supérieur
- 35 kg Cajón · Drawer · Tiroir

- Panel Vertical Portaherramientas (Opcional)
Tool-Keeper Board. (Optional)
Panneau Porte-Outils Vertical (Optionnel)
- 7 Cajones con Protección de Caucho Antideslizante
Drawers with Anti-Slip Rubber Protection
Tiroirs avec Protection Caoutchouc Anti-glisse

Part N°	€
025-005	757,79
Panel • Tool-Keeper • Panneau	
025-005P	74,63

• Elija Opción · Choose Option · Choisir Votre Option



A
B
C
D

• Dim. Cajón · Dim. Drawer · Dim. Tiroir
570 x 410 mm

025

Carro Metálico de 5 Cajones

5 Drawer Metallic Trolley • Servante Métallique 5 Tiroirs



680 x 458 x 812 mm

Cargas máximas permitidas:
Max. Load · Charges Max.

- 700 kg Bandeja Superior
Top Floor · Plateau Supérieur
- 35 kg Cajón · Drawer · Tiroir

- 5 Cajones con Protección de Caucho Antideslizante
Drawers with Anti-Slip Rubber Protection
Tiroirs avec Protection Caoutchouc Anti-glisse

Part N°	€
025-007	603,92

• Elija Opción · Choose Option · Choisir Votre Option



A
B
C
D

• Dim. Cajón · Dim. Drawer · Dim. Tiroir
570 x 410 mm

Carros Taller para Bandejas Combinables • Trolleys for EVA Foams • Servantes pour Panneaux de Mousse Modulables

025

Carro Metálico de 7 Cajones con Bandeja Abatible

7 Drawer Metallic Trolley • Servante Métallique 7 Tiroirs et Plateau Escamotable

- Bandeja Abatible
Folding Tray
Plateau Escamotable



724 x 470 x 1.032 mm



- Cierre con Bloqueo
Blocking Lock
Fermeture Verrouillable

- 7 Cajones con Protección de Caucho Antideslizante
Drawers with Anti-Slip Rubber Protection
Tiroirs avec Protection Caoutchouc Anti-glisce

Part N°	€
025-012	1.173,60

Cargas máximas permitidas:
Max. Load · Charges Max.

- 790 kg Bandeja Superior
Top Tray · Plateau Supérieur
- 35 kg Cajón · Drawer · Tiroir

- Elija Opción · Choose Option · Choisir Votre Option



A

B

C

D

- Dim. Cajón · Dim. Drawer · Dim. Tiroir
570 x 410 mm

025

Carro Metálico de 7 Cajones

7 Drawer Metallic Trolley • Servante Métallique 7 Tiroirs



688 x 458 x 885 mm

- 7 Cajones con Protección de Caucho Antideslizante
Drawers with Anti-Slip Rubber Protection
Tiroirs avec Protection Caoutchouc Anti-glisce

Part N°	€
025-009	823,26

Cargas máximas permitidas:
Max. Load · Charges Max.

- 400 kg Bandeja Superior
Top Tray · Plateau Supérieur
- 35 kg Cajón · Drawer · Tiroir

- Elija Opción · Choose Option · Choisir Votre Option



A

B

C

D

- Dim. Cajón · Dim. Drawer · Dim. Tiroir
589 x 410 mm

025

Banco Móvil de Trabajo con Panel Vertical Portaherramientas

Mobile Work Center with Tool-Keeper Board • Servante-Etabli Mobile Avec Panneau Porte-Outils Vertical

- Panel Vertical Portaherramientas. Elevación Neumática. Tool-Keeper Board. Pneumatic Elevation. Panneau Porte-Outils Vertical à Elevation Pneumatique



- 6 Cajones con Protección de Caucho Antideslizante. Drawers with Anti-Slip Rubber Protection. Tiroirs avec Protection Caoutchouc Anti-glisse

1.035 x 458 x 1.052 mm

Part N°	€
025-001	2.156,59

Cargas máximas permitidas:
Max. Load • Charges Max.

- 800 kg Tablero Superior
Top Board • Plateau Supérieur
- 20 kg Bandejas Extraíbles
Removable Trays • Plateaux Extractibles
- 45 kg Cajón Superior
Top Drawer • Tiroir Supérieur
- 30 kg Cajón
Drawer • Tiroir

- Tablero de Madera Maciza
Solid Wooden Board
Plan de Travail en Bois Massif

- Armario con 2 Cajones
Cabinet with 2 Drawers
Armoire avec 2 Tiroirs



- Cajón Superior
Top Drawer • Tiroir Supérieur
895 x 410 mm

- Elija Opción
Choose Option • Choisir Votre Option

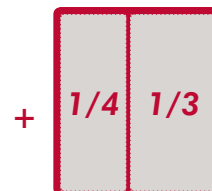

- Cajones Inferiores
Bottom Drawers • Tiroirs Inférieurs
535 x 410 mm



Accesorios para Paneles • Accessories for Tool-Keeper Board • Accessoires pour Panneaux

013

Gancho Doble para Panel
Double Hook for Tool-Keeper Board
Crochet Double pour Panneau Porte-Outils

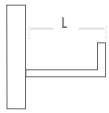

56 x 65 x 35 mm

L mm	Part N°	€
30	013-001	3,00

013

Gancho Simple para Panel
Simple Hook for Tool-Keeper Board
Crochet Simple pour Panneau Porte-Outils

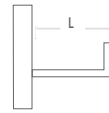

56 x 65 x 35 mm

L mm	Part N°	€
30	013-002	3,00

013

Gancho Doble Largo para Panel
Double Long Hook for Tool-Keeper Board
Crochet Double Long pour Panneau Porte-Outils

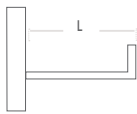

56 x 65 x 87 mm

L mm	Part N°	€
87	013-003	4,20

013

Gancho Anilla para Panel
Ring Hook for Tool-Keeper Board
Crochet fermé Pour Panneau Porte-Outils

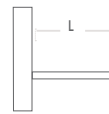

72 x 76 x 30 mm

L mm	Part N°	€
25	013-004	4,13

013

Regleta para Destornilladores en Panel
Screwdriver Rack for Trolley
Rangement Tournevis pour Panneau Porte-Outils



370 x 65 x 34 mm

	L mm	Part N°	€
12	370	013-005	15,00



Separadores para Cajones • Separation Metal Plates • Séparateurs pour Tiroirs

013

Separadores Metálicos
Metal Separation Plates • Séparateurs Métalliques



013-010



013-012

	L mm	L1 mm	Part N°	€
6	376	47	013-010	7,88
5	565	47	013-012	9,00

013

Rail para Separadores
Metal Separation Plate Guide • Rail pour Séparateur



	L mm	L1 mm	Part N°	€
17	565	61	013-011	10,13

013-011 • Rail para Separadores
Separation Plate Guide
Rail pour Séparateur

013-012 • Separador Horizontal
Horizontal Separation Plate
Séparateur Horizontal

013-010 • Separador Vertical
Vertical Separation Plate
Séparateur Vertical



Seiton

Un lugar para cada herramienta y cada herramienta en su lugar

A place for every tool and every tool in its place

Une place pour chaque outil et chaque outil à sa place



- Archivador para Documentos
Briefcase Compartment
Compartment pour Documents



- Lengueta que facilita la extracción de la bandeja del compartimento
Smart pull-out to help getting the assortment out of the compartment
Langnette facilitant l'extraction du panneau du tiroir



- Exclusivo para Bandejas Combinables DOGHER
Exclusive to be used with DOGHER EVA Foam Trays
Exclusif pour Panneaux de Mousse Modulables DOGHER

Caja Seiton • Seiton Case • Caisse Seiton

010

Caja SEITON para Bandejas de 1/3
SEITON Case for 1/3 EVA Foam Trays
Caisse Seiton pour Panneaux de 1/3



1/3
375 x 188 x 30 mm

425 x 230 x 110 mm

Part N°	€
010-1/3	27,18

010

Caja SEITON para Bandejas de 1/4 y 1/2
SEITON Case for 1/4 & 1/2 FoamTrays
Caisse Seiton pour Panneaux de 1/4 et 1/2



1/4
375 x 140 x 30 mm

1/2
375 x 280 x 30 mm

425 x 335 x 110 mm

Part N°	€
010-1/2	30,30

011

Base SEITON para Bandejas de 1/3
SEITON Base for 1/3 EVA Foam Trays
Base SEITON pour Panneaux de 1/3



1/3
375 x 188 x 30 mm

425 x 230 x 55 mm

Part N°	€
011-1/3	13,59

011

Base SEITON para Bandejas de 1/4 y 1/2
SEITON Base for 1/4 & 1/2 FoamTrays
Base SEITON pour Panneaux de 1/4 et 1/2



1/4
375 x 140 x 30 mm

1/2
375 x 280 x 30 mm

425 x 335 x 55 mm

Part N°	€
011-1/2	15,15



• Base SEITON Apilable
Attachable SEITON Base
Base SEITON Empilable



1/4
375 x 140 x 30 mm

Alicates • Pliers • Pinces

200

Alta Potencia
High Leverage • Haute Performance

4
Pcs



Part N°	€
200-080	122,97

205

Profesionales
Professional • Professionnelles

4
Pcs



Part N°	€
205-080	79,78

220

Arandelas Seeger
Circlip® Pliers • Pinces Circlip®

4
Pcs



Part N°	€
220-080	86,48

250

Aislados 1000V
Insulated 1000V • Isolées 1000V

3
Pcs



Part N°	€
250-080	90,80

225

Mini-Alicates
Mini-Pliers • Mini-Pinces

4
Pcs



Part N°	€
225-080	63,48

237

Mini-Alicates ESD
ESD Mini-Pliers • Mini-Pinces ESD

4
Pcs



Part N°	€
237-080	69,48

Tenazas y Destornilladores • Locking Pliers & Screwdrivers • Pincas-Étaux et Tournevis

1/4
375 x 140 x 30 mm

276

Tenazas Grip
Locking Pliers • Pincas-Étaux

3
Pcs



• 125mm • 175mm • 250mm

Part N°	€
276-080	62,75

303

Industrial Plus
Industrial Plus • Industriel Plus

6
Pcs

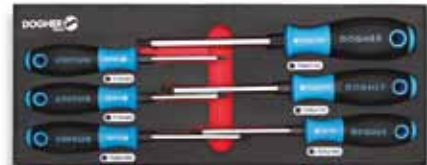

T10 • T15 • T20 • T25 • T30 • T40

Part N°	€
303-080	54,38

300

Industrial Plus
Industrial Plus • Industriel Plus

6
Pcs

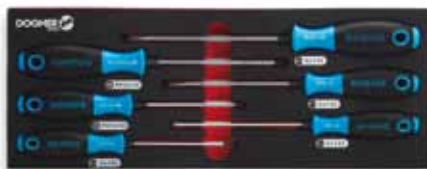

Recta Milled Electricien 3 • 4 • 5 • 6 PH1 • PH2

Part N°	€
300-080	62,89

300

Industrial Plus
Industrial Plus • Industriel Plus

6
Pcs

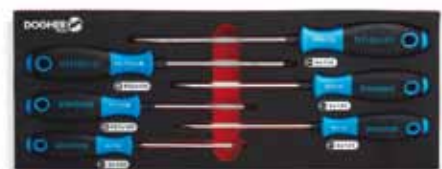

Recta Milled Electricien 3 • 4 • 5 • 6 PZ1 • PZ2

Part N°	€
300-081	62,89

315

Industrial
Industrial • Industriel

5
Pcs

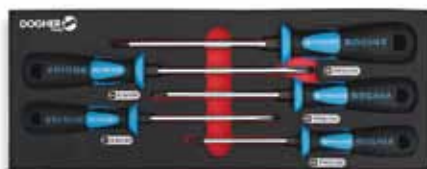

Recta Milled Electricien 5,5 • 6,5 PH1 • PH2 • PH3

Part N°	€
315-080	48,14

315

Industrial
Industrial • Industriel

5
Pcs

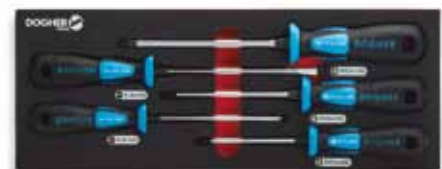

Recta Milled Electricien 5,5 • 6,5 PZ1 • PZ2 • PZ3

Part N°	€
315-081	48,14

1/4
375 x 140 x 30 mm

Destornilladores • Screwdrivers • Tournevis

330

Profesional
Professional • Professionnel

5
Pcs



Plana
Stamped
Mécanicien

5,5 • 6,5

PH1 • PH2 • PH3



Part N°	€
330-080	36,49

330

Profesional
Professional • Professionnel

5
Pcs



Plana
Stamped
Mécanicien

5,5 • 6,5

PZ1 • PZ2 • PZ3



Part N°	€
330-081	37,93

351

Serie Anti-Slip
Anti-Slip Series • Série Anti-glisse

6
Pcs

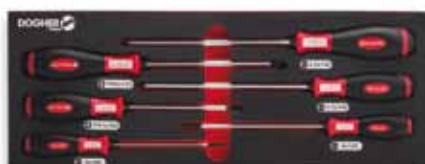

Recta
Milled
Electricien

3 • 4 • 5,5 • 6,5

PH1 • PH2



Part N°	€
351-080	43,53

351

Serie Anti-Slip
Anti-Slip Series • Série Anti-glisse

6
Pcs

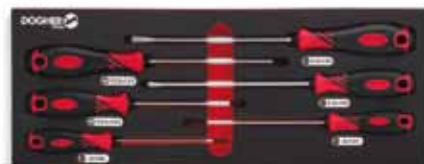

Recta
Milled
Electricien

3 • 4 • 5,5 • 6,5

PZ1 • PZ2



Part N°	€
351-081	44,66

360

Aislados 1000V
Insulated 1000V • Isolés 1000V

7
Pcs



Recta
Milled
Electricien

3 • 4 • 5,5 • 6,5

PH0 • PH1 • PH2



Part N°	€
360-080	63,80

360

Aislados 1000V
Insulated 1000V • Isolés 1000V

7
Pcs



Recta
Milled
Electricien

3 • 4 • 5,5 • 6,5

PZ0 • PZ1 • PZ2



Part N°	€
360-081	64,29

Llaves y Martillos • Wrenches & Hammers • Clés et Marteaux

1/4
375 x 140 x 30 mm

450

Llaves Fijas
Double Open Ended Wrenches • Clés à Fourches

8
Pcs



6x7 • 8x9 • 10x11 • 12x13 • 14x15 • 16x17 • 18x19 • 20x22

Part N°	€
450-080	57,12

451

Llaves Combinadas
Combination Wrenches • Clés Mixtes

8
Pcs



8 • 10 • 11 • 12 • 13 • 14 • 17 • 19
15°

Part N°	€
451-080	74,88

460

Llaves de Tubo Hexagonal
Double Ended Hex Socket Wrenches
Clés à Béquille Doubles Forjées

8
Pcs



6x7 • 8x9 • 10x11 • 12x13 • 14x15 • 16x17 • 18x19 • 20x22

Part N°	€
460-080	133,00

702

Martillos
Hammers • Marteaux

2
Pcs



Part N° 702-320 • 731-35

Part N°	€
700-080	32,48

491

Llaves Ajustables Moleta Lateral
Spanish Adjustable Wrenches
Clés à Molette Latérales

3
Pcs



150mm • 200mm • 250mm

Part N°	€
491-080	101,00

493

Llaves Ajustables Profesionales
Professional Adjustable Wrenches
Clés à Molette Professionnelles

3
Pcs



150mm • 200mm • 250mm

Part N°	€
493-080	69,38

1/4
375 x 140 x 30 mm

Vasos • Sockets • Douilles

500

Vasos Hexagonales 1/4"
Hexagonal Sockets 1/4" • Douilles Hexagonales 1/4"

46
Pcs

1/4"



Part N°	€
500-081	294,95

Vasos • Sockets • Douilles

4 • 4,5 • 5 • 5,5 • 6 • 7 • 8 • 9 • 10
11 • 12 • 13 • 14

Serie Larga • Deep • Série Longue

6 • 7 • 8 • 9 • 10 • 11 • 12 • 13 • 14

Vasos con Puntas • Socket Bits • Douilles-Embouts de Vissage

HX3 • HX4 • HX5 • HX6 • HX7 • HX8
T10 • T15 • T20 • T25 • T30 • T40
PH1 • PH2 • PH3
PZ1 • PZ2

Llave de Carraca • Ratched Handle • Cliquet

72 dientes
72 teeth • 72 dents

Destornillador • Spinner Handle • Tournevis

DOGHER

Alargadores • Extensions • Rallonges

100 mm
50 mm

Flexible • Flexible • Flexible

145 mm

Articulación Universal

Universal Joint • Cardan Universel



Mango Corredizo en T

Sliding "T" Handle • Manche en "T" à Glissement



501

Vasos Bihexagonales 1/4"
Bi-hexagonal Sockets 1/4" • Douilles Bi-Hexagonales 1/4"

46
Pcs

1/4"



Part N°	€
501-081	294,95

Vasos • Sockets • Douilles

4 • 4,5 • 5 • 5,5 • 6 • 7 • 8 • 9 • 10
11 • 12 • 13 • 14

Serie Larga • Deep • Série Longue

6 • 7 • 8 • 9 • 10 • 11 • 12 • 13 • 14

Vasos con Puntas • Socket Bits • Douilles-Embouts de Vissage

HX3 • HX4 • HX5 • HX6 • HX7 • HX8
T10 • T15 • T20 • T25 • T30 • T40
PH1 • PH2 • PH3
PZ1 • PZ2

Llave de Carraca • Ratched Handle • Cliquet

72 dientes
72 teeth • 72 dents

Destornillador • Spinner Handle • Tournevis

DOGHER

Alargadores • Extensions • Rallonges

100 mm
50 mm

Flexible • Flexible • Flexible

145 mm

Articulación Universal

Universal Joint • Cardan Universel



Mango Corredizo en T

Sliding "T" Handle • Manche en "T" à Glissement



516

Vasos Hexagonales 3/8"
Hexagonal Sockets 3/8" • Douilles Hexagonales 3/8"

22
Pcs

3/8"



Part N°	€
516-080	186,59

Vasos • Sockets • Douilles

6 • 7 • 8 • 9 • 10 • 11 • 12 • 13 • 14 • 15 • 16 • 17 • 18 • 19 • 20 • 21 • 22

Llave de Carraca • Ratched Handle • Cliquet

72 dientes
72 teeth • 72 dents

Alargadores • Extensions • Rallonges

100 mm
50 mm

Articulación Universal

Universal Joint • Cardan Universel



Mango Corredizo en T

Sliding "T" Handle • Manche en "T" à Glissement



Vasos • Sockets • Douilles

1/4
375 x 140 x 30 mm

502

Serie Larga 1/4" - 3/8" - 1/2"
Deep Series 1/4" - 3/8" - 1/2"
Série Longue 1/4" - 3/8" - 1/2"

18
Pcs



1/4"

4 · 5 · 6 · 7 · 8 · 9 · 10

3/8"

10 · 11 · 12 · 13 · 14 · 15

1/2"

16 · 17 · 18 · 19 · 22

Part N°	€
502-080	169,88

503

Vasos Torx 1/4" - 1/2"
Torx Sockets 1/4" - 1/2"
Douilles Torx 1/4" - 1/2"

29
Pcs



1/4"

E4 · E5 · E6 · E7 · E8

T6 · T7 · T8 · T9 · T10 · T15

1/2"

E10 · E11 · E12 · E14 · E16 · E18 · E20 · E22 · E24

TS20 · TS25 · TS27 · TS30 · TS40 · TS45 · TS50 · TS55 · TS60

Part N°	€
503-080	232,42

534

Vasos con Punta 1/2"
Socket Bits 1/2"
Douilles-Embouts de Vissage 1/2"

26
Pcs



1/2"

4 · 5 · 6 · 7 · 8 · 10 · 12 · 14 · 17 · 19

T20 · T25 · T27 · T30 · T40 · T45 · T50 · T55 · T60

5 · 6 · 8 · 10 · 12 · 14 · 16

Part N°	€
534-080	293,25

538

Vasos con Punta 1/2"
Socket Bits 1/2"
Douilles-Embouts de Vissage 1/2"

12
Pcs



1/2"

5 · 6 · 7 · 8 · 12 100mm · 5 · 10 140mm

T40 · T55 120mm

8 · 10 · 12 100mm

Part N°	€
538-080	184,49

010

Bandeja Organizadora
Organizer EVA Foam Tray • Panneau Organizer

Part N°	€
010-080	22,33



1/2
375 x 280 x 30 mm

Vasos y Llaves en "T" • Sockets & T-Handles • Douilles et Clés en "T"

500

Vasos Hexagonales o Bihexagonales 1/4" - 1/2"

Hexagonal or Bi-hexagonal Sockets 1/4" - 1/2" • Douilles Hexagonales ou Bi-Hexagonales 1/4" - 1/2"

43
Pcs



1/2" Vasos • Sockets • Douilles para Bujías • Spark Plug • pour Bougies
10 • 11 • 12 • 13 • 14 • 15 • 16 • 17 • 18 • 19 • 20 • 21 • 22 • 24 • 27 • 30 • 32 • 16 • 21

Llave de Carraca • Ratched Handle • Cliquet



Articulación Universal
Universal Joint • Cardan Universel



Alargadores • Extensions • Rallonges



Adaptador Triple Función
3-Way Adapter • Adaptateur avec Triple Fonction



1/4" Vasos • Sockets • Douilles
4 • 4,5 • 5 • 5,5 • 6 • 7 • 8 • 9 • 10 • 11 • 12 • 13 • 14

Llave de Carraca • Ratched Handle • Cliquet



Articulación Universal
Universal Joint • Cardan Universel



Alargadores • Extensions • Rallonges



Mango Corredizo en T
Sliding "T" Handle • Manche en "T" à Glissement



Destornillador • Spinner Handle • Tournevis



Vasos Sockets • Douilles	Part N°	€
Hexagonal	500-080	362,12
Bihexagonal	501-080	362,12

618

Hexagonal Redonda

Ball Nose Hex • Hexagonale Tête Sphérique

10
Pcs



2 • 2,5 • 3 • 4 • 5 • 6 • 7 • 8 • 10 • 12

Part N°	€
618-080	119,29

620

Torx Seguridad

Torx Tamper • Torx Sécurité

10
Pcs

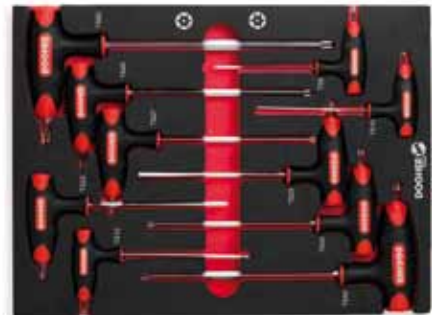

TS9 • TS10 • TS15 • TS20 • TS25 • TS27 • TS30 • TS40 • TS45 • TS50

Part N°	€
620-080	102,49

Alicates y Destornilladores • Pliers & Screwdrivers • Pinces et Tournevis

1/3
375 x 188 x 30 mm

205

Profesionales
Professional • Professionnelles

4
Pcs



250mm 160mm 160mm 180mm

Part N°	€
205-081	95,90

250

Aislados 1000V
Insulated 1000V • Isolées 1000V

4
Pcs



TESTED



160mm 180mm 240mm 160mm

Part N°	€
250-081	131,58

296

Bandeja para Electricista
Electrician Tray • Panneau Électricien

3
Pcs



296-056 296-051 296-002

Part N°	€
296-080	57,93

330

Mixto Aislado 1000V y Profesional
Insulated 1000V and Professional
Isolés 1000V et Professionnels

10
Pcs



TESTED



4 • 5,5 • 6,5 PH1 • PH2 4 • 5,5 • 6,5 PH1 • PH2
Recta • Milled • Electricien Plana • Stamped • Mécanicien

Part N°	€
330-084	80,86

330

Profesionales
Professional • Professionnelles

7
Pcs



Recta Milled Electricien 3 • 4 • 5,5 • 6,5 PH0 • PH1 • PH2

Part N°	€
330-082	43,86

330

Profesionales
Professional • Professionnelles

7
Pcs



Recta Milled Electricien 3 • 4 • 5,5 • 6,5 PZ0 • PZ1 • PZ2

Part N°	€
330-083	45,08

1/3
375 x 188 x 30 mm

Llaves • Wrenches • Clés

450 Llaves Fijas
Double Open Ended Wrenches • Clés à Fourches

10
Pcs



• 6x7 • 8x9 • 10x11 • 12x13 • 14x15
• 16x17 • 18x19 • 20x22 • 21x23 • 24x26

Part N°	€
450-081	83,06

451 Llaves Combinadas
Combination Wrenches • Clés Mixtes

10
Pcs

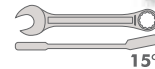

• 8 • 10 • 11 • 12 • 13 • 14 • 17 • 19 • 22 • 24

Part N°	€
451-081	108,44

453 Llaves de Estrella Acodadas
Double Ring Wrenches
Clés Polygonales Contre-coudées

6
Pcs

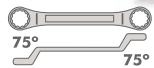

• 8x9 • 10x11 • 12x13 • 14x15 • 16x17 • 18x19

Part N°	€
453-080	76,57

455 Carraca Reversible Acodada
Double Box 15° Gear Wrenches
Clés à Cliquet Réversibles Coudées à 15°

9
Pcs

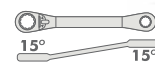

• 8x9 • 10x11 • 12x13 • 14x15 • 16x18 • 17x19

1/4" • 3/8" • 1/2"

Part N°	€
455-080	231,55

457 Llaves Combinadas de Carraca Reversibles
Combination Gear Wrenches
Clés Mixtes à Cliquet Réversibles

10
Pcs



• 10 • 12 • 13 • 14
• 15 • 17 • 19

1/4" • 3/8" • 1/2"

Part N°	€
457-080	218,03

467 Llaves de Vaso Articulas Dobles
Double Flexible Socket Wrenches
Clés à Douilles Articulées

6
Pcs



• 8x9 • 10x11 • 12x13 • 14x15 • 16x17 • 18x19

Part N°	€
467-080	124,01

500

Vasos Hexagonales 1/4"
Hexagonal Sockets 1/4" • Douilles Hexagonales 1/4"

36
Pcs

1/4"



Part N°	€
500-083	252,50

Vasos • Sockets • Douilles

5,5 • 6 • 7 • 8 • 9 • 10 • 11 • 12 • 13 • Serie Larga • Deep • Série Longue

Vasos con Puntas • Socket Bits • Douilles-Embouts de Vissage

HX3 • HX4 • HX5 • PH1 • PH2 • PH3 • PZ1 • PZ2 • PZ3
HX6 • HX7 4 • 5,5 • 6,5

Llave de Carraca • Ratched Handle • Cliquet

72 dientes
72 teeth • 72 dents

Destornillador • Spinner Handle • Tournevis



Alargadores • Extensions • Rallonges

100 mm
50 mm

Adaptador Espacios Confinados
Palm Driver
Adaptateur pour Accès Difficiles

Mango Corredizo en T

Sliding "T" Handle • Manche en "T" à Glissement

Articulación Universal

Universal Joint • Cardan Universel



Juego de Llaves en Navaja • Folding Key Set • Jeu de Clés sur Monture

1,5 • 2 • 2,5 • 3 • 4 • 5 • 6 • 8

530

Vasos Bihexagonales 1/2"
Bi-hexagonal Sockets 1/2" • Douilles Bi-Hexagonales 1/2"

27
Pcs

1/2"



Part N°	€
530-080	252,33

Vasos • Sockets • Douilles

8 • 9 • 10 • 11 • 12 • 13 • 14 • 15 • 16 • 17 • 18 • 19 • 20 • 21 • 22 • 23 • 24 • 27 • 30 • 32

Llave de Carraca • Ratched Handle • Cliquet

72 dientes
72 teeth • 72 dents

Articulación Universal

Universal Joint • Cardan Universel



Alargadores • Extensions • Rallonges

250 mm
125 mm

Adaptador Triple Función

3-Way Adapter • Adaptateur avec Triple Fonction

3/8" • 1/2"

Vasos para Bujías • Spark Plug Sockets • Douilles pour Bougies

16 • 21

1/3
375 x 188 x 30 mm

Vasos • Sockets • Douilles

531

Vasos Hexagonales 1/2"
Hexagonal Sockets 1/2" • Douilles Hexagonales 1/2"

27
Pcs

1/2"



Part N°	€
531-080	252,33

Vasos • Sockets • Douilles

8 • 9 • 10 • 11 • 12 • 13 • 14 • 15 • 16 • 17 • 18 • 19 • 20 • 21 • 22 • 23 • 24 • 27 • 30 • 32

Llave de Carraca • Ratched Handle • Cliquet



72 dientes
72 teeth • 72 dents

Alargadores • Extensions • Rallonges



250 mm
125 mm

Articulación Universal

Universal Joint • Cardan Universel



Adaptador Triple Función

3-Way Adapter • Adaptateur avec Triple Fonction

• 3/8" • 1/2"

Vasos para Bujías • Spark Plug Sockets • Douilles pour Bougies

16 • 21

570

Serie de Impacto 1/2"
Impact Series 1/2" • Série Impact 1/2"

25
Pcs

1/2"



Part N°	€
570-080	362,72

Vasos de Impacto • Impact Sockets • Douilles

8 • 9 • 10 • 11 • 12 • 13 • 14 • 15 • 16 • 17 • 18 • 20 • 21 • 22 • 24

Serie Larga

Deep • Série Longue

17 • 19 • 21 • 22 • 24

Vasos Impacto Color

Colour Impact Sockets • Douilles Impact Couleur

17 • 19 • 21

Alargadores • Extensions • Rallonges



125 mm

Adaptador • Adapter • Adaptateur

• 3/8" • 1/2"

572

Serie de Impacto 1/2"
Impact Series 1/2" • Série Impact 1/2"

23
Pcs

1/2"



Part N°	€
572-080	405,23

Vasos de Impacto • Impact Sockets • Douilles

E10 • E12 • E14 • E16 • E18 • E20 • E24

T25 • T27 • T30 • T40 • T45 • T50 • T55 • T60

5 • 6 • 8 • 10 • 12 • 14 • 17 • 19

Composición de Bandejas Combinables • EVA Foams Composition • Composition des Panneaux Modulaires

1/4 375 x 140 x 30 mm	200-080 200-180 202-160 201-160 207-200	205-080 205-180 208-160 212-160 212-180	220-080 220-180 221-180 222-180 223-180	250-080 250-180 251-160 255-160	225-080 225-125 227-125 230-125 231-125	237-080 237-125 239-125 242-125 243-125	20
	276-080 276-125 276-175 276-250	303-080 303-T10 303-T15 303-T20 303-T25 303-T30 303-T40	300-080 300-030-100 300-040-125 300-050-125 300-060-150 301-PH1-100 301-PH2-125	300-081 300-030-100 300-040-125 300-050-125 300-060-150 302-PZ1-100 302-PZ2-125	315-080 315-055-125 315-065-150 317-PH1-100 317-PH2-125 317-PH3-150	315-081 315-055-125 315-065-150 318-PZ1-100 318-PZ2-125 318-PZ3-150	21
	330-080 330-055-125 330-065-125 334-PH1-100 334-PH2-125 334-PH3-150	330-081 330-055-125 330-065-125 337-PZ1-100 337-PZ2-125 337-PZ3-150	351-080 351-030-100 351-040-125 351-055-150 351-065-150 352-PH1-100 352-PH2-125	351-081 351-030-100 351-040-125 351-055-150 351-065-150 353-PZ1-100 353-PZ2-125	360-080 360-030-100 360-040-100 360-055-125 360-065-150 361-PH0-060 361-PH1-080 361-PH2-100	360-081 360-030-100 360-040-100 360-055-125 360-065-150 362-PZ0-060 362-PZ1-080 362-PZ2-100	22
	450-080 450-06-07 450-08-09 450-10-11 450-12-13 450-14-15 450-16-17 450-18-19 450-20-22	451-080 451-08 451-10 451-11 451-12 451-13 451-14 451-17 451-19	460-080 460-06-07 460-08-09 460-10-11 460-12-13 460-14-15 460-16-17 460-18-19 460-20-22	702-081 702-320 731-35	491-080 491-150 491-200 491-250	493-080 493-150 493-200 493-250	23
1/2 375 x 280 x 30 mm	618-080 618-02 618-02,5 618-03 618-04 618-05		620-080 620-TS09 620-TS10 620-TS15 620-TS20 620-TS25		620-080 620-TS27 620-TS30 620-TS40 620-TS45 620-TS50		26
	205-081 205-180 208-160 212-160 265-250	250-081 250-180 251-160 255-160 258-240	296-080 296-051 296-002 296-056	330-084 330-040-100 330-055-125 330-065-150 334-PH1-100 334-PH2-125 360-040-100 360-055-125 360-065-150 361-PH1-080 361-PH2-100	330-082 330-030-075 330-040-100 330-055-125 330-065-150 334-PH0-075 334-PH1-100 334-PH2-125	330-083 330-030-075 330-040-100 330-055-125 330-065-150 337-PZ0-075 337-PZ1-100 337-PZ2-125	27
450-081 450-06-07 450-08-09 450-10-11 450-12-13 450-14-15 450-16-17 450-18-19 450-20-22 450-21-23 450-24-26	451-081 451-08 451-10 451-11 451-12 451-13 451-14 451-17 451-19 451-22 451-24	453-080 453-08-09 453-10-11 453-12-13 453-14-15 453-16-17 453-18-19	455-080 455-08-09 455-10-11 455-12-13 455-14-15 455-16-18 455-17-19 476-1/4-10 476-3/8-13 476-1/2-19	457-080 457-10 457-12 457-13 457-14 457-15 457-17 457-19 476-1/4-10 476-3/8-13 476-1/2-19	467-080 467-08-09 467-10-11 467-12-13 467-14-15 467-16-17 467-18-19	28	

• Contacte con nosotros para la consulta de contenidos de bandejas combinables de Vasos

Contact us in order to check contents of Socket EVA foams · Nous contacter pour toute information relative au contenu des panneaux modulaires de Douilles

Carros de Taller Ligeros • Light Duty Trolleys • Servantes Légères

025

Carro Metálico con 2 Cajones y Apertura Superior

Metallic Trolley with 2 Drawers and Top Opening Lid • Servante Métallique 2 Tiroirs et Ouverture Supérieure



- Almacén Superior
Top Store
Rangement Supérieur

- 2 Cajones con Protección de Caucho Antideslizante
Drawers with Anti-Slip Rubber Protection
Tiroirs avec Protection Caoutchouc Anti-glisse

705 x 370 x 830 mm

Part N°	€
025-003	360,24

Cargas máximas permitidas:
Max. Load · Charges Max.

- 40 kg Almacén Superior
Top Store · Rangement Supérieur
- 40 kg Almacén Inferior
Bottom Store · Rangement Inférieur
- 25 kg Cajón
Drawer · Tiroir
- 165 kg Carga Total
Total Load · Charge Totale

025

Carro Metálico con 3 Bandejas y 1 Cajón

Metallic Trolley with 3 Floors & 1 Drawer • Servante Métallique 3 Plateaux et 1 Tiroir



- 1 Cajón con Protección de Caucho Antideslizante
Drawer with Anti-Slip Rubber Protection
Tiroir avec Protection Caoutchouc Anti-glisse

737 x 383 x 845 mm

Part N°	€
025-010	326,61

Cargas máximas permitidas:
Max. Load · Charges Max.

- 45 kg Tablero Superior
Top Board · Plateau Supérieur
- 50 kg Bandeja
Tray · Plateau
- 25 kg Cajón
Drawer · Tiroir
- 170 kg Carga Total
Total Load · Charge Totale

025

Carro Metálico con 3 Bandejas

Metallic Trolley with 3 Floors • Servante Métallique 3 Plateaux



719 x 365 x 780 mm

Part N°	€
025-011	172,83

Cargas máximas permitidas:
Max. Load · Charges Max.

- 45 kg Bandeja
Tray · Plateau
- 135 kg Carga Total
Total Load · Charge Totale

Mesas de Trabajo • Work Benches • Etablis

027

Mesa Metálica de Trabajo con 3 Cajones
3 Drawer Metal Work Bench • Etabli Métallique 3 Tiroirs

- 3 Cajones de Alta Capacidad
High Capacity Drawers
Tiroirs Grande Capacité



2000 x 640 x 865 mm

Part N°	€
027-001	888,34

Cargas máximas permitidas:
Max. Load · Charges Max.

- 245 kg Tablero Superior
Top Board · Plateau Supérieur
- 150 kg Balda Inferior
Bottom Board · Plateau Inférieur
- 35 kg Cajón
Drawer · Tiroir
- 500 kg Carga Total
Total Load · Charge Totale

027

Mesa Metálica de Trabajo con 2 Cajones y Panel Vertical Portaherramientas
2 Drawer Metal Work Bench with Tool-Keeper Board
Etabli Métallique 2 Tiroirs et Panneau Porte-Outils Vertical

- Panel Vertical Portaherramientas.
Tool-Keeper Board.
Panneau Porte-Outils Vertical



1500 x 640 x 1550 mm

Part N°	€
027-004	920,87

Cargas máximas permitidas:
Max. Load · Charges Max.

- 530 kg Tablero Superior + Panel Portaherramientas
Top Board + Tool-keeper Board
Plateau Supérieur + Panneau Porte-outils
- 300 kg Balda Inferior
Bottom Board · Plateau Inférieur
- 35 kg Cajón
Drawer · Tiroir
- 900 kg Carga Total
Total Load · Charge Totale

- 2 Cajones de Alta Capacidad
High Capacity Drawers
Tiroirs Grande Capacité

Mesas de Trabajo • Work Benches • Etablis

027

Mesa Metálica de Trabajo con 5 Cajones y Panel Vertical Portaherramientas Opcional
5 Drawer Metal Work Bench with Optional Tool-Keeper Board
Etabli Métallique 5 Tiroirs et Panneau Porte-Outils Vertical Optionnel

- Tablero de Madera Maciza
Solid Wooden Board
Plan de Travail en Bois Massif



1372 x 508 x 865 mm

- 5 Cajones Alta Capacidad
High Capacity Drawers
Tiroirs Grande Capacité



Part N°	€
027-002	941,07
Panel • Tool-Keeper • Panneau	
027-002P	114,43

Cargas máximas permitidas:
Max. Load • Charges Max.

- 360 kg Tablero de Madera Maciza
Solid Wooden Board
Plan de Travail en Bois Massif
- 20 kg Balda Superior
Top Shelf • Plateau Supérieur
- 40 kg Balda Inferior
Bottom Shelf • Plateau Inférieur
- 27 kg Cajón
Drawer • Tiroir
- 555 kg Carga Total
Total Load • Charge Totale

- Panel Vertical Portaherramientas
Tool-Keeper Board
Panneau Porte-Outils Vertical
1360 x 30 x 715 mm

Carros Modulares • Modular Trolleys • Caisse à Outils Mobiles et Modulables

051

Trolley de 3 Módulos
3 Floor Trolley • Caisse à Outils 3 Modules



580 x 360 x 670 mm



Part N°	€
051-001	252,00

- 1 Caja de Herramientas
Tool Box • Caisse à Outils
- 1 Cajón Alta Capacidad
High Capacity Drawer • Tiroir Grande Capacité
- 1 Arcón Abatible
Folding Chest • Coffre à Outils
- Frentes y laterales Metálicos
Front and Side Metal Faces
Parties Frontales et Latérales Métalliques
- Doble Cierre Metálico de Seguridad
Double Metal Safety Lock
Double Fermeture Métallique de Sécurité

Carros Modulares • Modular Trolleys • Caisse à Outils Mobiles et Modulables

051

Trolley de 3 Módulos
3 Floor Trolley • Caisse à Outils 3 Modules



580 x 360 x 775 mm



Part N°	€
051-002	257,25

- 1 Caja de Herramientas
Tool Box • Caisse à Outils
- 2 Cajones Alta Capacidad
High Capacity Drawers • Tiroirs Grande Capacité
- 1 Arcón Abatible
Folding Chest • Coffre à Outils
- Frentes y laterales Metálicos
Front and Side Metal Faces
Parties Frontales et Latérales Métalliques
- Doble Cierre Metálico de Seguridad
Double Metal Safety Lock
Double Fermeture Métallique de Sécurité

051

Trolley de 3 Módulos
3 Floor Trolley • Caisse à Outils 3 Modules



505 x 330 x 835 mm



Part N°	€
051-004	146,21

- 1 Caja de Herramientas
Tool Box • Caisse à Outils
- 3 Cajones Alta Capacidad
High Capacity Drawers • Tiroirs Grande Capacité
- 1 Arcón Abatible
Folding Chest • Coffre à Outils
- Ruedas de Plástico Alta Resistencia
High Resistance Plastic Wheels
Roues Plastique Haute Résistance

051

Trolley de 2 Módulos
2 Floor Trolley • Caisse à Outils 2 Modules



485 x 310 x 635 mm



Part N°	€
051-005	91,09

- 1 Caja de Herramientas
Tool Box • Caisse à Outils
- 1 Arcón Alta Capacidad
High Capacity Chest • Coffre à Outils Grande Capacité
- Organizador Circular
Round Organizer
Organizer Circulaire
- Bolsa de Nylon Frontal
Frontal Nylon Bag
Sacoche Textile Frontale

Cajas de Herramientas Móviles • Mobile Tool Boxes • Caisse à Outils Mobiles

051

Caja de Herramientas Móvil
Mobile Tool Box • Caisse à Outils Mobile



750 x 650 x 440 mm



Part N°	€
051-007	196,88

2 Módulos

Floors · Modules

- Doble Cierre Metálico de Seguridad
Double Metal Safety Lock
Double Fermeture Métallique de Sécurité

051

Caja de Herramientas Móvil
Mobile Tool Box • Caisse à Outils Mobile



620 x 370 x 420 mm



Part N°	€
051-006	112,88

3 Organizadores para Accesorios

Accessory Organizers

Organizers pour Accessoires

Cajas de Herramientas • Tool Boxes • Caisse à Outils

026

Caja de Herramientas Metálica Profesional

Professional Metal Tool Box • Caisse à Outils Métallique Professionnelle



495 x 235 x 340 mm



Part N°	€
026-001	66,71

5 Bandejas Alta Capacidad
High Capacity Trays
Compartiments Grande Capacité

• **30 kg** Carga Máxima Total permitida
Max. Total Load · Charge Max. Totale

026

Caja de Herramientas Metálica Profesional

Professional Metal Tool Box • Caisse à Outils Métallique Professionnelle



495 x 200 x 240 mm



Part N°	€
026-002	52,69

3 Bandejas Alta Capacidad
High Capacity Trays
Compartiments Grande Capacité

• **30 kg** Carga Máxima Total permitida
Max. Total Load · Charge Max. Totale

026

Caja de Herramientas Metálica Profesional

Professional Metal Tool Box • Caisse à Outils Métallique Professionnelle



510 x 218 x 250 mm



Part N°	€
026-003	93,88

1 Bandeja
Tray · Compartment

2 Cajones
Drawers · Tiroirs

• **Doble Cierre Metálico de Seguridad**
Double Metal Safety Lock
Double Fermeture Métallique de Sécurité

• **30 kg** Carga Máxima Total permitida
Max. Total Load · Charge Max. Totale

Cajas de Herramientas • Tool Boxes • Caisse à Outils

050

Caja de Herramientas Profesional
Professional Tool Box • Caisse à Outils Professionnelle



454 x 210 x 230 mm



Part N°

€

050-001

76,76

5 Bandejas Alta Capacidad
High Capacity Trays
Compartiments Grande Capacité

050

Caja de Herramientas Profesional
Professional Tool Box • Caisse à Outils Professionnelle



515 x 210 x 230 mm



Part N°

€

050-002

89,13

5 Bandejas Alta Capacidad
High Capacity Trays
Compartiments Grande Capacité

050

Caja de Herramientas Profesional
Professional Tool Box • Caisse à Outils Professionnelle



472 x 254 x 212 mm



Part N°

€

050-003

72,16

1 Bandeja Interior Portátil
Portable Tray Inside • Plateau Intérieur Amovible

- Frentes y Laterales Metálicos
Front and Side Metal Faces
Parties Frontales et Latérales Métalliques
- Doble Cierre Metálico de Seguridad
Double Metal Safety Lock
Double Fermeture Métallique de Sécurité

Cajas de Herramientas • Tool Boxes • Caisse à Outils

050

Caja de Herramientas Profesional
Professional Tool Box • Caisse à Outils Professionnelle



533 x 282 x 246 mm



Part N°	€
050-004	83,66

- 1 Bandeja Interior Portátil
Portable Tray Inside · Plateau Intérieur Amovible
- Frentes y Laterales Metálicos
Front and Side Metal Faces
Parties Frontales et Latérales Métalliques
- Doble Cierre Metálico de Seguridad
Double Metal Safety Lock
Double Fermeture Métallique de Sécurité

050

Caja de Herramientas Profesional
Professional Tool Box • Caisse à Outils Professionnelle



593 x 310 x 282 mm



Part N°	€
050-005	91,89

- 1 Bandeja Interior Portátil
Portable Tray Inside · Plateau Intérieur Amovible
- Frentes y Laterales Metálicos
Front and Side Metal Faces
Parties Frontales et Latérales Métalliques
- Doble Cierre Metálico de Seguridad
Double Metal Safety Lock
Double Fermeture Métallique de Sécurité

050

Caja de Herramientas Profesional
Professional Tool Box • Caisse à Outils Professionnelle



500 x 275 x 265 mm



Part N°	€
050-006	48,88

- 1 Bandeja Interior Portátil
Portable Tray Inside · Plateau Intérieur Amovible
- Doble Cierre Metálico de Seguridad
Double Metal Safety Lock
Double Fermeture Métallique de Sécurité

Cajas de Herramientas • Tool Boxes • Caisse à Outils

050

Caja de Herramientas Alta Capacidad
High Capacity Tool Box • Caisse à Outils Grande Capacité



650 x 275 x 265 mm



Part N°

€

050-007

61,41

- 1 Bandeja Interior Portátil
Portable Tray Inside · Plateau Intérieur Amovible
- Doble Cierre Metálico de Seguridad
Double Metal Safety Lock
Double Fermeture Métallique de Sécurité

050

Caja de Herramientas
Tool Box • Caisse à Outils



325 x 180 x 150 mm



Part N°

€

050-008

15,18

- 1 Bandeja Interior Portátil
Portable Tray Inside · Plateau Intérieur Amovible
- 2 Organizadores para Accesorios
Accessory Organizers · Organizers pour Accessoires
- Cierre Metálico de Seguridad
Metal Safety Lock
Fermeture Métallique de Sécurité

050

Caja de Herramientas Alta Capacidad
High Capacity Tool Box • Caisse à Outils Grande Capacité



410 x 230 x 200 mm



Part N°

€

050-009

24,44

- 1 Bandeja Interior Portátil
Portable Tray Inside · Plateau Intérieur Amovible
- 2 Organizadores para Accesorios
Accessory Organizers · Organizers pour Accessoires
- Cierre Metálico de Seguridad
Metal Safety Lock
Fermeture Métallique de Sécurité

Cajas de Herramientas • Tool Boxes • Caisse à Outils

050

Caja de Herramientas
Tool Box • Caisse à Outils



490 x 262 x 250 mm



Part N°

€

050-010

37,95

- 1 Bandeja Interior Portátil
Portable Tray Inside · Plateau Intérieur Amovible
- 3 Organizadores para Accesorios
Accessory Organizers · Organizers pour Accessoires
- Doble Cierre Metálico de Seguridad
Double Metal Safety Lock
Double Fermeture Métallique de Sécurité

050

Caja de Herramientas Alta Capacidad
High Capacity Tool Box • Caisse à Outils Grande Capacité



553 x 320 x 310 mm



Part N°

€

050-011

60,09

- 1 Bandeja Interior Portátil
Portable Tray Inside · Plateau Intérieur Amovible
- 2 Organizadores para Accesorios
Accessory Organizers · Organizers pour Accessoires
- Doble Cierre Metálico de Seguridad
Double Metal Safety Lock
Double Fermeture Métallique de Sécurité

050

Caja de Herramientas Alta Capacidad
High Capacity Tool Box • Caisse à Outils Grande Capacité



640 x 250 x 240 mm



Part N°

€

050-013

82,51

- 1 Organizador para Accesorios
Accessory Organizer
Organizer pour Accessoires

Cajas de Herramientas • Tool Boxes • Caisse à Outils

050

Caja de Herramientas Alta Capacidad
High Capacity Tool Box • Caisse à Outils Grande Capacité



710 x 270 x 260 mm



Part N°

€

050-014

96,89

1 Organizador para Accesorios
Accessory Organizer
Organizer pour Accessoires

050

Caja de Herramientas
Tool Box • Caisse à Outils



585 x 266 x 340 mm



Part N°

€

050-017

124,20

1 Bandeja Superior
Top Tray • Compartiment Supérieur
3 Cajones
Drawers • Tiroirs
• Doble Cierre Metálico de Seguridad
Double Metal Safety Lock
Double Fermeture Métallique de Sécurité

050

Conjunto de 3 Cajas de Herramientas
Toolbox 3 Pieces Pack • Ensemble de 3 Caisse à Outils

3
Pcs

342 x 170 x 150 mm

420 x 220 x 195 mm

510 x 290 x 245 mm



Part N°

€

050-015

83,38

1 Bandeja Interior Portátil
Portable Tray Inside • Plateau Intérieur Amovible
2 Organizadores para Accesorios
Accessory Organizers
Organizers pour Accessoires

Cajas de Herramientas • Tool Boxes • Caisses à Outils

050

Conjunto de 3 Cajas de Herramientas

Toolbox 3 Pieces Pack • Ensemble de 3 Caisses à Outils

3
Pcs



330 x 180 x 165 mm

420 x 225 x 210 mm

595 x 285 x 285 mm



Part N°	€
050-016	114,31

- 5 Organizadores para Accesorios
Accessory Organizers • Organizers pour Accessoires
- Doble Cierre Metálico de Seguridad
*Double Metal Safety Lock
Double Fermeture Métallique de Sécurité*
- Alojamiento Especial para Brocas
*Special Drill Box Enclosed
Logement Spécifique pour Forets*



Arcones para Herramientas • Tool Chests • Coffres à Outils

028

Arcón Metálico para Herramientas

Metal Tool Chest • Coffre Métallique à Outils



668 x 316 x 386 mm



Part N°	€
028-001	370,94

- 1 Bandeja Superior
Top Tray • Compartiment Supérieur
- 6 Cajones
Drawers • Tiroirs
- 5 kg Carga Máxima Total permitida por Cajón
*Drawer Max. Total Load
Charge Max. Totale pour Tiroir*

Arcones • Chests • Coffres

028

Arcón Metálico
Metal Chest • Coffre Métallique

555 x 230 x 210 mm



Part N°

€

028-002

72,00

- Cierre Metálico de Seguridad
Metal Safety Lock
Fermeture Métallique de Sécurité
- 40 kg Carga Máxima Total permitida
Max. Total Load · Charge Max. Totale

028

Arcón Metálico Capacidad Media
Medium Capacity Metal Chest • Coffre Métallique Capacité Moyenne

759 x 327 x 250 mm



Part N°

€

028-003

121,90

- Cierre Metálico de Seguridad
Metal Safety Lock
Fermeture Métallique de Sécurité
- 50 kg Carga Máxima Total permitida
Max. Total Load · Charge Max. Totale

028

Arcón Metálico Alta Capacidad
High Capacity Metal Chest • Coffre Métallique Grande Capacité

1.144 x 367 x 380 mm



Part N°

€

028-004

139,45

- Cierre Metálico de Seguridad
Metal Safety Lock
Fermeture Métallique de Sécurité
- 50 kg Carga Máxima Total permitida
Max. Total Load · Charge Max. Totale

028

Arcón Metálico Capacidad Premium
Premium Capacity Metal Chest • Coffre Métallique Très Grande Capacité

1.429 x 502 x 476 mm



Part N°

€

028-005

277,75

- Cierre Metálico de Seguridad
Metal Safety Lock
Fermeture Métallique de Sécurité
- 60 kg Carga Máxima Total permitida
Max. Total Load · Charge Max. Totale

Organizadores • Organizers • Organizers

052

Maleta Organizadora
Organizer Case • Valise Organizer



Part N°		€
052-001	27	53,76

360 x 290 x 195 mm

052

Caja Organizadora
Organizer Box • Caisse Organizer



Part N°		€
052-002	18 x 4	41,40

- Bandeja Superior
Top Tray • Compartiment Supérieur

279 x 184 x 254 mm

052

Arcón Organizador
Organizer Chest • Coffre Organizer



Part N°		€
052-003	13 x 4	99,76

- Incluye 4 Organizadores
4 Organizers Included
Inclut 4 Organizers
052-010

377 x 265 x 310 mm

052

Organizador de Columna
Column Organizer • Organizer en Colonne

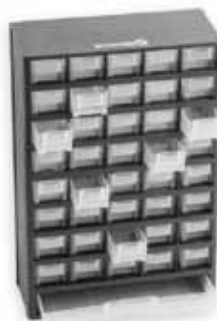

Part N°		€
052-004	40	48,88

310 x 138 x 490 mm

052

Organizador de Columna
Column Organizer • Organizer en Colonne



Part N°		€
052-005	42	62,39

380 x 165 x 440 mm

052

Organizador con Asa Rígida
Solid Handle Organizer • Organizer à Anse Rigide



Part N°		€
052-006	15	13,92

- Cajas Organizadoras Extraíbles
Removable Organizing Cases
Compartiments Amovibles

210 x 338 x 62 mm

Organizadores • Organizers • Organizers

052

Organizador con Asa Rígida Capacidad Media
Medium Capacity Solid Handle Organizer
Organizer à Anse Rigide Capacité Moyenne



Part N°		€
052-007	17	26,85

- Cajas Organizadoras Extraíbles
Removable Organizer Cases
Compartiments Amovibles

420 x 335 x 62 mm

052

Organizador con Asa Rígida Alta Capacidad
High Capacity Solid Handle Organizer
Organizer à Anse Rigide Grande Capacité



Part N°		€
052-008	8	37,09

- Cajas Organizadoras Extraíbles
Removable Organizer Cases
Compartiments Amovibles

420 x 334 x 115 mm

052

Organizador Simple
Simple Organizer
Organizer Simple



Part N°		€
052-009	8	8,17

- Cajas Organizadoras Extraíbles
Removable Organizer Cases
Compartiments Amovibles

240 x 195 x 55 mm

052

Organizador con Asa Móvil Alta Capacidad
High Capacity Mobile Handle Organizer
Organizer à Anse Mobile Grande Capacité



Part N°		€
052-010	13	18,23

- Cajas Organizadoras Extraíbles
Removable Organizer Cases
Compartiments Amovibles

340 x 250 x 60 mm

052

Organizador con Asa Rígida
Solid Handle Organizer
Organizer à Anse Rigide



Part N°		€
052-011	21	11,04

- Compartimentos Adaptables
Adjustable Compartments
Compartiments Ajustables

320 x 260 x 50 mm

052

Organizador con Asa Rígida Capacidad Media
Medium Capacity Solid Handle Organizer
Organizer à Anse Rigide Capacité Moyenne



Part N°		€
052-012	21	17,83

- Compartimentos Adaptables
Adjustable Compartments
Compartiments Ajustables

380 x 310 x 60 mm

Organizadores • Organizers • Organizers

052

Organizador con Asa Rígida Alta Capacidad
High Capacity Solid Handle Organizer
Organizer à Anse Rigide Grande Capacité



Part N°		€
052-013	24	28,75

- Compartimentos Adaptables
Adjustable Compartments
Compartiments Ajustables

480 x 380 x 80 mm

052

Organizador
Organizer • Organizer



Part N°		€
052-014	18	4,72

230 x 125 x 35 mm

052

Organizador Capacidad Media
Medium Capacity Organizer
Organizer Capacité Moyenne



Part N°		€
052-015	18	7,59

292 x 186 x 42 mm

052

Organizador Alta Capacidad
High Capacity Organizer
Organizer Grande Capacité



Part N°		€
052-016	24	12,36

382 x 234 x 48 mm

052

Organizador Doble
Double Organizer • Organizer Double



Part N°		€
052-018	30	18,23

- Compartimentos Adaptables
Adjustable Compartments
Compartiments Ajustables

320 x 260 x 80 mm

052

Organizador Doble Alta Capacidad
High Capacity Double Organizer
Organizer Double Grande Capacité



Part N°		€
052-019	36	23,00

- Compartimentos Adaptables
Adjustable Compartments
Compartiments Ajustables

380 x 290 x 80 mm

Porta-Herramientas • Drill Holsters • Fourreaux et Sacs à Outils

Características de los Porta-Herramientas

Tool Holder Features

Caractéristiques des Fourreaux

075

Porta-Herramientas para Electricistas

Electrician Tool Holder • Fourreau pour Electriciens



Nylon

• Nylon con costuras reforzadas
Heavy duty Nylon knitting
Nylon à coutures renforcées

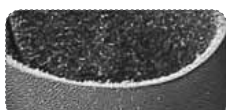

HQ

• Cuero de Alta Calidad
Hard Wearing Premium Leather
Cuir Haute Qualité



• Remaches de Alta Resistencia
Rivets Reinforced
Rivets Haute Résistance



• Incluye cadena para cinta aislante y porta-flexómetro
Including chain insulating tape for and flexometer holster
Chaîne pour Ruban Isolant et Porte-mètre

160 x 155 x 50 mm

Part N°	€
075-014	32,09

075

Porta-Herramientas Universal

Tool Holder for General Purpose • Fourreau Universel

075

Bolsa para Cutters y Destornilladores

Knife and Tool Holder • Fourreau pour Cutters et Tournevis



• 2 Bolsillos laterales para herramientas de mayor longitud
2 Side pockets for longer tools
2 poches latérales pour outils de plus grande longueur

235 x 175 x 70 mm

Part N°	€
075-017	40,02



210 x 125 x 55 mm

Part N°	€
075-018	19,73

Porta-Herramientas • Drill Holsters • Fourreaux et Sacs à Outils

075

Porta-Taladro (Zurdos y Diestros)
Drill Holster (Left and Right Handed)
Fourreau Perceuse (Gaucher / Droitier)



- Compartimentos para puntas y brocas
Compartments for bits and drills
Compartiments pour embouts de vissage

290 x 170 x 85 mm

Part N°	€
075-007	40,24

075

Porta-Flexómetro
Measuring Tape Holder • Fourreau pour Mètre



- Flexómetros de 3 a 10 m.
3 to 10 m. flexometers
Mètres de 3 à 10 m.

165 x 120 x 75 mm

Part N°	€
075-011	14,53

075

Porta-Herramientas Universal Electricista
Universal Electrician Drill Holster
Fourreau Universel pour Electricien



- Alojamiento específico para alicates, destornilladores y cutters
Specific storage for screwdrivers, pliers and cutters
Logements spécifiques pour pinces, tournevis et cutters

315 x 250 x 140 mm

Part N°	€
075-002	45,91

076

Bolsa para Herramientas
Universal Tote • Sac à Outils



- Gran cantidad de alojamientos interiores y exteriores, imprescindible para el profesional.
High storage capacity perfect for professional purposes
Nombre important de logements intérieurs et extérieurs, indispensable pour le professionnel

290 x 220 x 185 mm

Part N°	€
076-006	48,47

Porta-Herramientas • Drill Holsters • Fourreaux et Sacs à Outils

075

Bolsa para Herramientas y Clavos
Tool and Nail Holder • Fourreau Outils et Clous



- Soporte metálico especial para martillos
Special metallic holder for hammers
Support métallique spécifiques pour marteaux

210 x 180 x 110 mm

Part N°	€
075-016	27,16

075

Bolsa para Herramientas y Clavos
Tool and Nail Holder • Fourreau Outils et Clous



- Doble bolsillo para clavos
Double pocket for nails
Double poche pour clous

265 x 260 x 135 mm

Part N°	€
075-004	40,98

076

Bolsa Porta-Herramientas para Cubo
Bucket Tote • Porte-Outils pour Seau



- Alta capacidad para herramientas manuales y electroportátiles
High storage capacity for hand and power tools
Grande capacité pour Outils à Main et électro-portatifs
- 18 Compartimentos versátiles
18 Versatile compartments
18 Compartiments versatiles
- Cintas regulables de rápida adaptación a cualquier tipo de cubo
Adjustable belts appropriate for any bucket
Sangles à réglage rapide pour tout type de seau



470 x 320 mm

- Cubo No Incluido
Bucket Not Included
Seau Non inclus

Part N°	€
076-009	28,84

Porta-Herramientas • Drill Holsters • Fourreaux et Sacs à Outils

076

Funda Porta-Herramientas con Asa
Tool Wrap With Handle • Sacoche Porte-Outils avec Poignée



- Asa reforzada ergonómica
Reinforced ergonomic carrying handle
Poignée ergonomique renforcée
- 18 Compartimentos versátiles
18 Versatile compartments
18 compartiments versatiles
- Cintas regulables de rápida adaptación
Adjustable belts
Sangles à réglage rapide

350 x 195 x 85 mm

Part N°	€
076-003	42,18

076

Mochila para Herramientas y Organizador
Professional Tool Rucksack with Organizer
Sac à Dos pour Outils et Organizer



- Asa reforzada ergonómica
Reinforced ergonomic carrying handle
Poignée ergonomique renforcée
- Incluye bolsillo especial para organizador
Special organising pocket included
Inclut une poche spéciale pour organizer

410 x 295 x 240 mm

Part N°	€
076-004	62,22



- Organizador No Incluido
Organizer Not Included
Organizer non inclus

076

Bolsa Universal para Herramientas
Tool Bag Gate Mouth 20" • Sac à Outils Universel



- Apertura rígida para fácil acceso al interior
Rigid opening for an easy use
Ouverture rigide pour un accès facilité à l'intérieur
- Gran capacidad de almacenamiento
High storage capacity
Grande capacité
- Forro resistente al agua
Water resistant inner lining
Doublure résistante à l'eau

520 x 250 x 290 mm

Part N°	€
076-012	68,87

Porta-Herramientas • Drill Holsters • Fourreaux et Sacs à Outils

076

Chaleco Portaherramientas Profesional
Worker Vest • Gilet Porte-Outils Professionnel



- Cintas regulables de rápida adaptación
Fast Adaptation Adjustable belts
Sangles à réglage rapide
- Tejido transpirable en la zona posterior
Breathable fabric at the back
Tissu respirant dans la partie postérieure
- 3 Bolsillos para herramientas y accesorios
3 Pockets for tools and accessories
3 Poches pour Outils et Accessoires
- 8 Alojamientos especiales para destornilladores
8 Special pockets for screwdrivers
8 logements spécifiques pour tournevis

640 x 500 mm

Part N°	€
076-008	63,93

075

Cinturón Cambio Rápido
Quick Release Belt • Ceinture à Attache Rapide

- Tejido transpirable
Breathable fabric
Tissu respirant
- Cierre de ajuste rápido
Quick adjusting closure
Fermeture rapide
- Cinta de Velcro para fácil adaptación
Velcro tape included
Bande Velcro pour réglage rapide
- Diseño especial para fundas y bolsas
Special design for sleeves and bags
Design spécial pour fourreau et Porte-Outils



1340 x 50 mm

Part N°	€
075-010	19,73

075

Rodilleras Ligeras
Light Duty Knee Pads • Genouillères Légères

- Tejido transpirable
Breathable fabric
Tissu respirant
- Cierre de ajuste rápido
Quick adjusting closure
Fermeture rapide
- Cinta de Velcro para fácil adaptación
Velcro tape included
Bande Velcro pour réglage rapide
- Cobertura de plástico ultra resistente
Ultra resistant plastic coverage
Couverture Plastique ultra-résistante



Part N°	€
075-023	28,31



		54
		55
		59
		60
		64
		66
		68
		69
		73
		75
		79

Serie **Alta Potencia** • **High Leverage** Series • Série **Haute Performance**



Mango Bimaterial
Bimaterial Handle
Manche Bi-matière

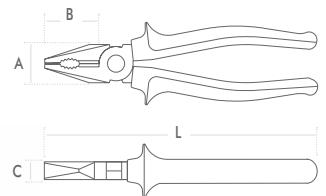

CrV 62HRC

• Consulte envase unitario con colgador
Hanging unit packaging available
Nous consulter pour présentation brochable



200

Alicate Universal de Alta Potencia
High Leverage Combination Plier • Pince Universelle Haute Performance

CrV



L mm	A mm	B mm	C mm		Part N°	€
160	23	32	10	5	200-160	21,80
180	26	36	12	5	200-180	22,18
200	29	40	13	5	200-200	24,40

201

Alicate de Corte Diagonal de Alta Potencia
High Leverage Diagonal Cutting Plier • Pince Coupante Diagonale Haute Performance

CrV



L mm	A mm	B mm	C mm		Part N°	€
160	22	21	10	5	201-160	21,65
180	24	26	11	5	201-180	23,53

202

Alicate de Bocas Semirredondas con Corte Alta Potencia
High Leverage Long Nose Plier • Pince Demi-Ronde à Becs Longs Haute Performance

CrV



L mm	A mm	B mm	C mm		Part N°	€
160	16	49	9	5	202-160	25,87
200	18	76	10	5	202-200	29,63

Serie **Profesional** • **Professional Series** • Série **Professionnelle**

205

Alicate Profesional Universal

Professional Combination Plier • Pince Universelle Professionnelle

CrV



L mm	A mm	B mm	C mm		Part N°	€
130	23	31	9	5	205-130	15,25
160	25	35	10	5	205-160	17,45
180	27	38	10	5	205-180	18,03
200	30	41	11	5	205-200	18,55

206

Alicate Profesional Universal con Capilla

Professional Raised Head Combination Plier • Pince Universelle Professionnelle

CrV



L mm	A mm	B mm	C mm		Part N°	€
160	25	35	11	5	206-160	22,33
180	24	41	12	5	206-180	24,72
200	30	41	12	5	206-200	27,12

208

Alicate Profesional de Bocas Semirredondas con Corte

Professional Long Nose Plier • Pince Demi-Ronde à Becs Longs Droits Professionnelle avec Coupe

CrV



L mm	A mm	B mm	C mm		Part N°	€
140	17	38	9	5	208-140	17,65
160	16	49	9	5	208-160	18,40
200	18	76	10	5	208-200	21,55

209

Alicate Profesional de Bocas Semirredondas Curvas con Corte

Professional Bent Nose Plier • Pince Demi-Ronde à Becs Longs Coudés Professionnelle

CrV



L mm	A mm	B mm	C mm		Part N°	€
160	16	44	9	5	209-160	18,40
200	18	76	10	5	209-200	21,55

Serie **Professional** • **Professional Series** • Série **Professionnelle**

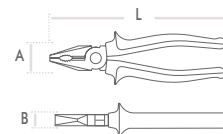

210

Alicate Profesional de Bocas Planas

Professional Flat Nose Plier • Pince à Becs Longs Plats Professionnelle

CrV



L mm	A mm	B mm	C mm		Part N°	€
160	16	49	9	5	210-160	18,40

211

Alicate Profesional de Bocas Redondas

Professional Round Nose Plier • Pince à Becs Ronds Professionnelle

CrV



L mm	A mm	B mm	C mm		Part N°	€
160	16	50	9	5	211-160	18,40

212

Alicate Profesional de Corte Diagonal

Professional Diagonal Cutting Plier • Pince Coupante Diagonale Professionnelle

CrV



L mm	A mm	B mm	C mm		Part N°	€
130	18	16	8	5	212-130	17,48
160	22	21	10	5	212-160	17,83
180	24	26	11	5	212-180	19,15

Serie **Profesional** • **Professional Series** • Série **Professionnelle**

213

Alicate Profesional de Corte Diagonal Reforzado

Professional Heavy Duty Diagonal Cutting Plier • Pince Coupante Diagonale Renforcée Professionnelle

CrV



L mm	A mm	B mm	C mm		Part N°	€
160	26	20	11	5	213-160	23,05
180	28	23	11	5	213-180	23,40
200	28	23	12	5	213-200	25,25

214

Alicate Profesional de Corte Frontal

Professional End Cutting Plier • Pince Coupante Devant Professionnelle

CrV



L mm	A mm	B mm	C mm		Part N°	€
160	31	7	25	5	214-160	24,40
180	39	8	29	5	214-180	25,25
200	39	10	32	5	214-200	25,65

215

Alicate Profesional Pelacables

Professional Wire Stripping Plier • Pince à Dénuder Professionnelle

CrV



L mm	A mm	B mm	C mm		Part N°	€
160	18	37	10	5	215-160	23,08

Serie **Professional** • **Professional Series** • Série **Professionnelle**

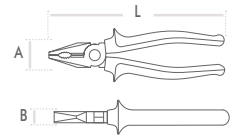

216

Alicate Profesional Universal Articulado de Alta Potencia
Professional Double Leverage Combination Plier
Pince Universelle Articulée Haute Performance Professionnelle

CrV



L mm	A mm	B mm	C mm		Part N°	€
200	25	33	11	4	216-200	42,20

217

Alicate Profesional Articulado Corte Diagonal Alta Potencia
Professional Double Leverage Diagonal Cutting Plier
Pince Coupante Diagonale Articulée Haute Performance Professionnelle

CrV



L mm	A mm	B mm	C mm		Part N°	€
180	25	12	11	4	217-180	42,20

207

Alicate Articulado de Corte Diagonal
Double Leverage Diagonal Plier • *Pince Coupante Diagonale Articulée*

CrV



L mm	A mm	B mm	C mm		Part N°	€
200	36	18	6	4	207-200	46,90

Alicates para Arandelas Seeger • Seeger Circlip® Pliers • Pinces pour Circlips®

220

Alicate Bocas Rectas Arandela Exterior

Straight Tips External Circlip® Plier • Pince Ouvrante à Becs Droits pour Circlips® Extérieur

CrV



L mm	Ø Min. mm	Ø Max. mm	Ø1 mm		Part N°	€
155	12	25	1,7	10	220-155	17,48
180	19	60	1,9	10	220-180	20,03
220	40	100	2,3	10	220-220	22,73
300	85	165	3,2	10	220-300	35,83

221

Alicate Bocas Curvas Arandela Exterior

Bent Tips External Circlip® Plier • Pince Ouvrante à Becs Coudés pour Circlips® Extérieur

CrV



L mm	Ø Min. mm	Ø Max. mm	Ø1 mm		Part N°	€
155	10	25	1,7	10	221-155	17,48
180	19	60	1,9	10	221-180	20,03
220	40	100	2,3	10	221-220	22,73
300	85	165	3,2	10	221-300	35,83

222

Alicate Bocas Rectas Arandela Interior

Straight Tips Internal Circlip® Plier • Pince Ouvrante à Becs Droits pour Circlips® Intérieur

CrV



L mm	Ø Min. mm	Ø Max. mm	Ø1 mm		Part N°	€
155	12	25	1,7	10	222-155	17,48
180	19	60	1,9	10	222-180	20,03
220	40	100	2,3	10	222-220	22,73
300	85	165	3,2	10	222-300	35,83

223

Alicate Bocas Curvas Arandela Interior

Bent Tips Internal Circlip® Plier • Pince Ouvrante à Becs Coudés pour Circlips® Intérieur

CrV



L mm	Ø Min. mm	Ø Max. mm	Ø1 mm		Part N°	€
155	12	25	1,7	10	223-155	17,48
180	19	60	1,9	10	223-180	20,03
220	40	100	2,3	10	223-220	22,73
300	85	165	3,2	10	223-300	35,83

Mini Alicate Profesional • Professional Miniplier • Mini-Pince Professionnelle

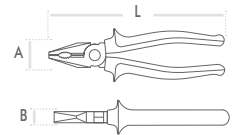

225

Mini Alicate Profesional Universal

Professional Combination Miniplier • Mini-Pince Universelle Professionnelle

CrV



L mm	A mm	B mm	C mm		Part N°	€
125	14	21	7	10	225-125	14,28

226

Mini Alicate Profesional de Bocas Planas

Professional Flat Nose Miniplier • Mini-Pince à Becs Longs Plats Professionnelle

CrV



L mm	A mm	B mm	C mm		Part N°	€
125	12	26	6	10	226-125	14,28

227

Mini Alicate Profesional de Bocas Semirredondas con Corte

Professional Long Nose Miniplier with Cutting • Mini-Pince Demi-Ronde à Becs Longs Droits Professionnelle avec Coupe

CrV



L mm	A mm	B mm	C mm		Part N°	€
125	12	27	6	10	227-125	14,28

228

Mini Alicate Profesional de Bocas Redondas

Professional Round Nose Miniplier • Mini-Pince à Becs Ronds Professionnelle

CrV



L mm	A mm	B mm	C mm		Part N°	€
125	11	25	6	10	228-125	14,28

Mini Alicate Profesional • Professional Miniplier • Mini-Pince Professionnelle

229

Mini Alicate Profesional de Bocas Semirredondas

Professional Noodle Nose Miniplier • Mini-Pince Demi-Ronde à Becs Longs Droits Professionnelle

CrV



L mm	A mm	B mm	C mm		Part N°	€
125	11	48	6	10	229-125	14,28

230

Mini Alicate Profesional con Corte Diagonal

Professional Diagonal Cutting Miniplier • Mini-Pince Coupante Diagonale Professionnelle

CrV



L mm	A mm	B mm	C mm		Part N°	€
125	11	14	6	10	230-125	14,28

231

Mini Alicate Profesional con Corte Frontal

Professional End Cutting Miniplier • Mini-Pince Coupante Devant Professionnelle

CrV



L mm	A mm	B mm	C mm		Part N°	€
125	16	5	6	10	231-125	14,28

Mini Alicate ESD • ESD Miniplier • Mini-Pince ESD

237

Mini Alicate Universal

Combination Miniplier • Mini-Pince Universelle



L mm	B mm	C mm		Part N°	€
125	20	8	10	237-125	15,78

238

Mini Alicate Bocas Planas

Flat Nose Miniplier • Mini-Pince à Becs Longs Plats



L mm	B mm	C mm		Part N°	€
125	36	8	10	238-125	15,78

239

Mini Alicate Bocas Semirredondas sin Corte

Long Nose Miniplier Without Cut • Mini-Pince Demi-Ronde à Becs Longs Droits Sans Coupe



L mm	B mm	C mm		Part N°	€
125	36	7	10	239-125	15,78

240

Mini Alicate Bocas Redondas

Round Nose Miniplier • Mini-Pince à Becs Ronds



L mm	B mm	C mm		Part N°	€
125	28	7	10	240-125	15,78

241

Mini Alicate Bocas Semirredondas con Corte

Long Nose Miniplier With Cut • Mini-Pince Demi-Ronde à Becs Longs Droits avec Coupe



L mm	B mm	C mm		Part N°	€
125	38	8	10	241-125	15,78

Mini Alicate ESD • ESD Miniplier • Mini-Pince ESD

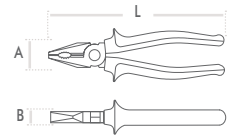

242

Mini Alicate Corte Diagonal
Diagonal Cutting Miniplier • Mini-Pince Coupante Diagonale



L mm	B mm	C mm		Part N°	€
125	38	8	10	242-125	15,78

243

Mini Alicate Corte Frontal
End Cutting Miniplier • Mini-Pince Coupante Devant



L mm	B mm	C mm		Part N°	€
125	9	14	10	243-125	15,78

244

Mini Alicate Corte Diagonal 21°
21° Diagonal Cutting Miniplier • Mini-Pince Coupante Diagonale Angle 21°



L mm	B mm	C mm		Part N°	€
125	8	4	10	244-125	15,78

245

Mini Alicate Corte Diagonal 45°
45° Diagonal Cutting Miniplier • Mini-Pince Coupante Diagonale Angle 45°



L mm	B mm	C mm		Part N°	€
125	8	4	10	245-125	15,78

Alicates Aislados • Insulated Pliers • Pincettes Isolées
250
Alicate Aislado Universal
Insulated Combination Plier • Pince Universelle Isolée

CrV



L mm	A mm	B mm	C mm		Part N°	€
160	23	32	10	4	250-160	25,85
180	26	36	12	4	250-180	26,65
200	29	40	13	4	250-200	30,30

251
Alicate Aislado Bocas Semirredondas Con Corte
Insulated Long Nose Plier with Cut • Pince Demi-Ronde à Becs Longs Droits Isolée avec Coupe

CrV



L mm	A mm	B mm	C mm		Part N°	€
160	18	53	10	4	251-160	29,68
200	21	60	11	4	251-200	31,10

252
Alicate Aislado Bocas Semirredondas Curvas Con Corte
Insulated Bent Nose Plier with Cut • Pince Demi-Ronde à Becs Longs Coudés Isolée avec Coupe

CrV



L mm	A mm	B mm	C mm		Part N°	€
160	18	53	10	4	252-160	30,20
200	21	60	11	4	252-200	32,23

253
Alicate Aislado Bocas Planas
Insulated Flat Nose Plier • Pince à Becs Longs Plats Isolée

CrV



L mm	A mm	B mm	C mm		Part N°	€
160	18	50	10	4	253-160	27,80

254
Alicate Aislado Bocas Redondas
Insulated Round Nose Plier • Pince à Becs Ronds Isolée

CrV



L mm	A mm	B mm	C mm		Part N°	€
160	18	50	10	4	254-160	27,80

Alicates Aislados • Insulated Pliers • Pincés Isolées

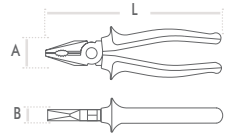

255

Alicate Aislado Corte Diagonal
Insulated Diagonal Cutting Plier • Pince Coupante Diagonale Isolée



L mm	A mm	B mm	C mm		Part N°	€
160	22	22	11	4	255-160	28,10
180	24	24	12	4	255-180	31,90

256

Alicate Aislado con Corte Diagonal Reforzado
Insulated Heavy Duty Diagonal Cutting Plier • Pince Coupante Diagonale Renforcée Isolée



L mm	A mm	B mm	C mm		Part N°	€
160	26	20	11	4	256-160	30,88
180	28	23	11	4	256-180	33,03
200	28	23	12	4	256-200	35,30

257

Alicate Pelacables Aislado
Insulated Wire Stripping Plier • Pince à Dénuder Isolée



L mm	A mm	B mm	C mm		Part N°	€
160	18	37	10	4	257-160	33,90

258

Tenacilla de Canal Aislada
Insulated Twin Slip-joint Water Pump Plier • Pince Multiprise à branche Entrepassée Isolée



L mm	○ mm	Part N°	€
240	40	258-240	38,03

Cortacables y Tenacillas • Cable Cutter & Water Pump Pliers • Coupe-câbles et Pincet Multiprises

262

Cortacables a Una Mano Cobre y Aluminio

Copper and Aluminium Cable Cutter • Coupe-câble Cuivre/Aluminium à Une Main

CrV



L mm	mm	Part N°	€
250	10	262-250	49,70

265

Tenacilla Ajuste Rápido • Quick Release Water Pump Plier • Pince Multiprise à Réglage Rapide

CrV



L mm	mm	Part N°	€
250	40	265-250	32,53

266

Tenacilla de Apertura Múltiple de Ojal • Notch-joint Water Pump Plier • Pince Multiprise à Secteurs

CrV



L mm	mm	Part N°	€
200	32	266-200	19,18
250	41	266-250	23,63
300	49	266-300	28,05

Cortacables y Tenacillas • Cable Cutter & Water Pump Pliers • Coupe-câbles et Pinces Multiprises

267

Tenacilla de Apertura Multiple de Canal con Mango Bimaterial

Bimaterial Handle Twin Slip-joint Water Pump Plier • Pince Multiprise à Branche Entrepasée Manche Bi-matière

CrV



L mm	○ mm	Part N°	€
250	48	267-250	25,58

268

Tenacilla de Apertura Multiple de Canal

Twin Slip-joint Water Pump Plier • Pince Multiprise à Branche Entrepasée

CrV



L mm	○ mm	Part N°	€
250	37	268-250	19,05

264

Tenacilla Profesional Autoajustable

Autoadjusting Professional Plier • Pince Multiprise Auto-réglable Professionnelle

CrV



L mm	○ mm	Part N°	€
175	26	264-175	38,90
240	38	264-240	44,95

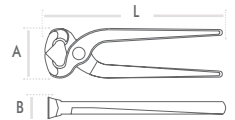

Tenazas Profesionales • Professional Pincers • Tenailles Professionnelles

270
Tenaza Profesional Alta Potencia

High Leverage Professional Pincer • Pince Coupante Devant Type Comté Professionnelle

CrV



L mm	A mm	B mm	Part N°	€
150	31	25	270-150	20,25
200	39	32	270-200	21,63
300	37	25	270-300	25,25

271
Tenaza Rusa Profesional

Professional Tower Pincer • Tenaille Russe Professionnelle

CrV



L mm	A mm	B mm	Part N°	€
225	29	20	271-225	12,90
250	33	24	271-250	14,18
280	36	26	271-280	15,50

272
Tenaza Rusa Profesional - Mango Plástico

Professional Dipped Handle Tower Pincer • Tenaille Russe Professionnelle - Manche Plastifié

CrV



L mm	A mm	B mm	Part N°	€
225	29	20	272-225	15,00
250	33	24	272-250	15,90
280	36	26	272-280	18,65

273
Tenaza de Carpintero Profesional

Professional Carpenter Pincer • Tenaille Professionnelle

CrV



L mm	A mm	B mm	Part N°	€
160	42	18	273-160	12,75
180	49	20	273-180	12,90
200	51	21	273-200	15,25
250	59	25	273-250	20,30

Tenazas Grip • Locking Pliers • Pincettes-Étau



276P

Tenaza Grip Plus de Boca Curva Con Corte
Curved Jaws Locking Plier With Wire Cutter • Pince-Étau Becs Coudés avec Coupe

CrMo

Plus



L mm	L "	B mm	A mm	Part N°	€
125	5	28	8	276P-125	20,55
175	7	38	10	276P-175	27,93
250	10	47	12	276P-250	30,45

Fácil Bloqueo y Desbloqueo • Easy Release Function • Blocage et Déblocage Facilités
25% más de Fuerza de Agarre • 25% more Grip Power • 25% de Puissance Supplémentaire
Garras con Diseño Antideslizante • Non-slip Jaw Design • Mors avec Design Anti-glisse

277P

Tenaza Grip Plus de Boca Recta Sin Corte
Straight Jaws Locking Plier Without Wire Cutter • Pince-Étau Becs Droits sans Coupe

CrMo

Plus



L mm	L "	B mm	A mm	Part N°	€
175	7	28	14	277P-175	28,35
250	10	38	17	277P-250	32,41

Fácil Bloqueo y Desbloqueo • Easy Release Function • Blocage et Déblocage Facilités
25% más de Fuerza de Agarre • 25% more Grip Power • 25% de Puissance Supplémentaire
Garras con Diseño Antideslizante • Non-slip Jaw Design • Mors avec Design Anti-glisse

275

Tenaza Grip Boca Curva Sin Corte
Curved Jaws Locking Plier Without Wire Cutter • Pince-Étau Becs Coudés sans Coupe

CrMo



L mm	L "	B mm	A mm	Part N°	€
175	7	30	10	275-175	18,49
250	10	49	12	275-250	21,37

Tenazas Grip • Locking Pliers • Pincet-Étau

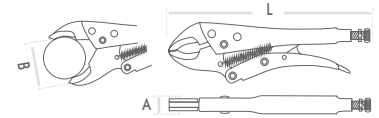

276

Tenaza Grip de Boca Curva Con Corte
Curved Jaws Plier With Wire Cutter • Pince-Étau Becs Coudés avec Coupe

CrMo



L mm	L "	B mm	A mm	Part N°	€
125	5	29	8	276-125	14,68
175	7	32	10	276-175	19,95
250	10	51	12	276-250	21,75

277

Tenaza Grip de Boca Recta Sin Corte
Straight Jaws Plier Without Wire Cutter • Pince-Étau Becs Droits sans Coupe

CrMo



L mm	L "	B mm	A mm	Part N°	€
175	7	29	15	277-175	20,25
250	10	43	16	277-250	23,15

274

Tenaza Grip Garra en "V"
"V" Jaws Locking Plier • Pince-Étau à Mors Inférieur Oval

CrMo



L mm	L "	B mm	A mm	Part N°	€
250	10	51	13	274-250	24,70

278

Tenaza Grip Boca Larga Con Corte
Long Nose Locking Plier With Wire cutter • Pince-Étau Becs Longs avec Coupe

CrMo



L mm	L "	B mm	A mm	Part N°	€
150	6	49	5~8	278-150	22,20
225	9	55	7~10	278-225	25,30

Tenazas Grip • Locking Pliers • Pinces-Étaux



279 Tenaza Grip para Soldador Horquilla de Acero
Welder's Grip Wrench • Pince-Étau pour Soudeur

CrV



L mm	L "	B mm	A mm	Part N°	€
225	9	60	70	279-225	25,48
275	11	87	70	279-275	34,15

280 Tenaza Grip para Tubo
Pipe Welder's Grip Wrench • Pince-Étau pour Soudeur de Tubes

CrV



L mm	L "	B mm	A mm	Part N°	€
275	11	84	70	280-275	36,68

281 Tenaza Grip Cadena
Locking Chain Plier • Pince-Étau à Chaîne

CrMo

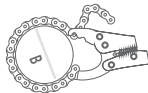

L mm	L "	B mm	A mm	Part N°	€
450	18	160	12,5	281-450	44,73

Cadena • Chain • Chaîne - 500 mm

Tenazas Grip • Locking Pliers • Pincettes-Étau

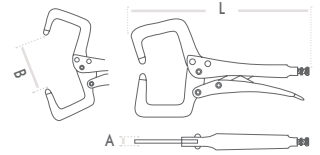

282

Tenaza Grip Cuello Cisne

Locking "C" Clamp • Pince-Étau soudure à l'arc - Modèle col de Cygne

CrV



L mm	L "	B mm	A mm	Part N°	€
150	6	29	10	282-150	20,30
275	11	92	14	282-275	30,58
600	24	357	14	282-600	69,70

283

Tenaza Grip Cuello Cisne Oscilante

Locking "C" Clamp with Swivel Pads

Pince-Étau soudure à l'arc - Modèle col de Cygne à Machoires Ajustables en Bout de Becs

CrV



L mm	L "	B mm	A mm	Part N°	€
150	6	42	22	283-150	25,13
275	11	95	28	283-275	34,25
450	18	200	28	283-450	55,61
600	24	365	28	283-600	77,53

284

Tenaza Grip para Soldar Chapas

Metal Sheet Welding Locking Plier • Pince-Étau pour Souder les Tôles

CrV



L mm	L "	B mm	A mm	Part N°	€
200	8	75	200	284-200	31,85

Tijeras Cortachapa • Aviation Tin Snips • Cisailles à Tôle

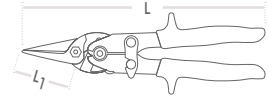
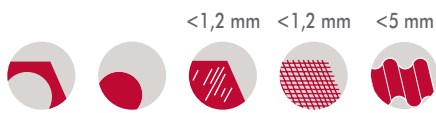

285

Tijera Cortachapa Corte Recto
Aviation Tin Snip Straight Cut • Cisaille Aviation Coupe Droite



L mm	L ₁ mm	Part N°	€
250	36	285-250	23,59

286

Tijera Cortachapa Corte Izquierdas
Aviation Tin Snip Left Cut • Cisaille Aviation Coupe à Gauche



L mm	L ₁ mm	Part N°	€
250	36	286-250	23,59

287

Tijera Cortachapa Corte Derechas
Aviation Tin Snip Right Cut • Cisaille Aviation Coupe à Droite



L mm	L ₁ mm	Part N°	€
250	36	287-250	23,59

Tijeras Cortachapa • Aviation Tin Snips • Cisailles à Tôle

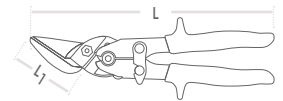
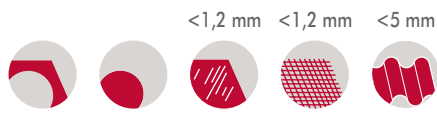

288

Tijera Cortachapa Acodada Corte Izquierdas
Offset Tin Snip Left Cut • Cisaille Coudée Coupe à Gauche



L mm	L ₁ mm	Part N°	€
250	36	288-250	27,73

289

Tijera Cortachapa Acodada Corte Derechas
Offset Tin Snip Right Cut • Cisaille Coudée Coupe à Droite



L mm	L ₁ mm	Part N°	€
250	36	289-250	27,73

291

Tijera Cortachapa Corte Recto Acodada Larga
Offset Long Tin Snip Straight Cut • Cisaille Coudée Longue Coupe Droite



L mm	L ₁ mm	Part N°	€
300	51	291-300	44,73

Cortabulones Profesional • Professional Bolt Cutters • Coupe-Boulons Professionnel

292

Cortabulones Profesional
Professional Bolt Cutter • Coupe-Boulons Professionnel

CrV



L mm	● mm	Part N°	€
200	0,5~2	292-200	36,63
300	1~3,5	292-300	48,05
320	2~6,5	292-320	55,89
470	4~8	292-470	74,56
630	5~11	292-630	93,52
750	6~13	292-750	127,68
900	8~17	292-900	174,23
1050	9~19	292-1050	217,48

293

Repuesto Boca Cortabulones Profesional
Spare Jaw for Professional Bolt Cutter • Tête Coupe-Boulons de Rechange

CrV

Apto para • Suitable for • Pour
292



● mm	Part N°	€
1~3,5	293-300	33,91
2~6,5	293-320	35,11
4~8	293-470	39,48
5~11	293-630	47,50
6~13	293-750	59,35
8~17	293-900	71,15
9~19	293-1050	103,44

294

Mini-Cortabulones Profesional
Professional Mini Bolt Cutter • Mini Coupe-Boulons Professionnel

CrV



L mm	● mm	Part N°	€
210	0,5~2	294-210	37,30

Cortaalambres Profesional • Professional Wire Cutters • Coupe-Câbles Professionnel

295

Cortaalambres Profesional a Dos Manos
Professional Wire Rope Cutter • Coupe-Câbles Professionnel

CrV



L mm	● mm	Part N°	€
450	5~12	295-001	242,00

295

Cortaalambres Profesional a Dos Manos
Professional Wire Rope Cutter • Coupe-Câbles Professionnel

CrV



L mm	● mm	Part N°	€
800	7~16	295-002	282,71

295

Cortaalambres Profesional a Una Mano
Professional Wire Rope Cutter • Coupe-Câbles Professionnel à Une Main

CrV



L mm	● mm	Part N°	€
250	1,5~3	295-003	34,50

295

Cortaalambres Profesional a Dos Manos
Professional Wire Rope Cutter • Coupe-Câbles Professionnel

CrV



L mm	● mm	Part N°	€
450	3~8	295-004	111,77

Cortaalambres Profesional • Professional Wire Cutters • Coupe-Câbles Professionnel

295 Cortaalambres Profesional a Dos Manos
Professional Wire Rope Cutter • Coupe-Câbles Professionnel

CrV



L mm	● mm	Part N°	€
600	10~14	295-005	133,27

295 Cortaalambres Profesional a Dos Manos
Professional Wire Rope Cutter • Coupe-Câbles Professionnel

CrV



L mm	● mm	Part N°	€
900	11~16	295-006	164,92

295 Cortaalambres Profesional a Dos Manos
Professional Wire Rope Cutter • Coupe-Câbles Professionnel

CrV



L mm	● mm	Part N°	€
1050	12~20	295-007	246,00

Cortaalambres Profesional • Professional Wire Cutters • Coupe-Câbles Professionnel

295

Cortaalambres Profesional a Una Mano
Professional Wire Rope Cutter
Coupe-Câbles Professionnel à Une Main

CrV



L mm	● mm	Part N°	€
200	0,5~4	295-008	49,09

295

Cortaalambres Profesional a Una Mano
Professional Wire Rope Cutter
Coupe-Câbles Professionnel à Une Main

CrV



L mm	● mm	Part N°	€
180	5~8	295-009	62,46

295

Cortador Profesional de Varilla Roscada
Professional Threaded Bar Cutter • Coupe Tige Filetée Professionnel

CrV



L mm	● mm	Part N°	€
760	M6, M8, M10	295-010	438,88

Tijeras para Electricista • Electrician Scissors • Ciseaux d'Electricien

296

Tijera Reforzada para Electricista con Ranura Pelacables
Heavy Duty Electrician Scissors with Stripping Notch • Ciseaux d'Electricien Renforcés avec Encoche de Dénudage

190 mm

Inox



L mm	Part N°	€
190	296-001	16,13

Tijeras para Electricista • Electrician Scissors • Ciseaux d'Electricien

296

Tijera para Electricista con Ranura Pelacables

Electrician Scissors with Stripping Notch • Ciseaux d'Electricien avec Encoche de Dénudage

140
mm

Inox



L mm	Part N°	€
140	296-002	10,00

296

Tijera para Electricista

Electrician Scissors • Ciseaux d'Electricien

140
mm

Inox



L mm	Part N°	€
140	296-003	10,00

296

Tijera Profesional para Electricista

Professional Electrician Scissors • Ciseaux d'Electricien Professionnels

145
mm

Inox



L mm	Part N°	€
145	296-006	15,88

- Hoja de sierra
Serrated blade · Lame crantée
- Capa interior con goma blanda
Inner layer with soft rubber · Couche intérieure en caoutchouc souple

296

Tijera para Electricista Empuñadura XXL

Heavy Duty Long Electrician Scissors Grip XXL • Ciseaux d'Electricien Prise XXL

150
mm

Inox



L mm	Part N°	€
150	296-004	19,99

- Hoja de sierra
Serrated blade · Lame crantée
- Capacidad máx. de corte hasta 1x50 mm²
Max. cutting capacity: 1x50 mm²
Capacité max de coupe 1x50 mm²



Tijeras y Navajas para Electricista • Electrician Scissors & Knives • Ciseaux et Couteaux d'Electricien

296

Tijera Aislada VDE para Electricista
VDE Insulated Electrician Scissors • Ciseaux d'Electricien Isolés 1000V

160
mm

Inox



L mm	Part N°	€
160	296-005	25,98

TESTED

296

Navaja para Electricista
Electrician Knife • Couteau pour Électricien

195
mm

Inox



L mm	Part N°	€
195	296-021	14,75



296

Navaja Aislada VDE de Corte Recto para Electricista
VDE Insulated Electrician Knife Straight Cut • Couteau d'Electricien à Coupe Droite Isolé 1000V

200
mm

Inox



L mm	Part N°	€
200	296-022	15,12



TESTED

296

Navaja Aislada VDE de Corte Curvo para Electricista
VDE Insulated Electrician Knife Curved Cut • Couteau d'Electricien à Coupe Courbe Isolé 1000V

200
mm

Inox



L mm	Part N°	€
200	296-023	21,11



TESTED

Pelamangueras • Cable Striper • Outils à Dégainer

296

Pelamangueras Profesional
Professional Cable Stripper
Outil à Dégainer Professionnel



L mm	mm	Part N°	€
190	8~28	296-031	17,96

- Cuchilla SK2 rectificada
Fully ground SK2 Blade · Lame à crochet SK2 rectifiée
- Mango antideslizante · PP & TPR anti-slip grip · Manche anti-glisse
- Ruleta para el ajuste de la profundidad de corte
Adjustable cutting depth
Roulette pour Ajuster la Profondeur de Coupe

296

Pelamangueras
Cable Stripper • Outil à Dégainer



L mm	mm	Part N°	€
140	8~28	296-032	23,01

- Palanca de giro 90°. Corte Longitudinal
Lever for 90° rotation of the blade
Lever à rotation 90°. Coupe longitudinale
- Gire la cabeza para el ajuste de la profundidad de corte
Turn the head to adjust cutting depth
Tourner la tête pour ajuster la profondeur de coupe

Repuestos para Pelamangueras • Cable Striper Spare Parts • Rechanges pour Outils à Dégainer

296R

Cuchilla para Pelamangueras
Cable Stripper Blade • Lame pour Outil à Dégainer

Apta para • Suitable for • Apte pour
296-031



L mm	mm	Part N°	€
115	8~28	296R-031	5,19

296R

Cuchilla para Pelamangueras
Cable Stripper Blade • Lame pour Outil à Dégainer

Apta para • Suitable for • Apte pour
296-032



L mm	mm	Part N°	€
23	8~28	296R-032	6,38

Alicates y Tenazas • Pliers & Pincers • Pincas et Tenailles

Pelacables y Cortacables • Wire Strippers & Wire Cutters • Pincas à Dénuder et Coupes-Câbles



296

Pelacables Multitarea Manual

Multitasking Wire Stripper • Pince à Dénuder Multi-fonctions Manuelle



Part N°	€
296-050	20,00

>9,5 mm  0,8~2,6 mm 

296

Pelacables Automático

Automatic Wire Stripper
Pince à Dénuder Automatique



Part N°	€
296-051	26,68



296

Pelacables de Pistola Ajustable

Self-adjusting Wire Stripper
Pince à Dénuder "Pistolet" Ajustable



Part N°	€
296-052	28,05

>8 mm  0,2~5 mm 

296

Cortacables de Precisión

Precision Wire Cutter • Coupe-Câbles de Précision



L mm	Part N°	€
130	296-053	7,50

Pelacables y Cortacables • Wire Strippers & Wire Cutters • Pinces à Dénuder et Coupes-Câbles

296

Cortacables Profesional

Professional Wire Cutter • Coupe-Câbles Professionnel



L mm	Part N°	€
130	296-054	7,50

296

Alicate para Terminales

Terminal Crimping Tool • Pince à Sertir 3 en 1



Pelar • Strip • Dénuder
0,8~3,2 mm²

Cortar • Cut • Couper
M2,6~M5



Prensar • Crimp • Sertir



1,6~4,6 mm



Prensar • Crimp • Sertir



L mm	Part N°	€
250	296-055	12,83

296

Alicate para Terminales

Terminal Crimping Tool • Pince à Sertir 3 en 1



Pelar • Strip • Dénuder
0,75~6 mm²

Cortar • Cut • Couper
M2,6~M5



Prensar • Crimp • Sertir
1,5~6 mm²



Prensar • Crimp • Sertir



L mm	Part N°	€
250	296-056	12,13

Pelacables y Cortacables • Wire Strippers & Wire Cutters • Pincettes à Dénuder et Coupes-Câbles

296

Alicate para Terminales

Terminal Crimping Tool • Pince à Sertir 3 en 1



Pelar • Strip • Dénuder
AWG 0,75~6 mm²

Cortar • Cut • Couper
M2,6~M5



Prensar • Crimp • Sertir
1,5~6 mm²



Prensar • Crimp • Sertir
1,5~4,6 mm²



L mm	Part N°	€
250	296-057	40,23

296

Cortacables - Pelacables

Wire Cutter-Stripper • Coupe-Câbles Dénudeur



Cortar • Cut • Couper
M2,5~M5



Cortar
Cut • Couper

Pelar
Strip • Dénuder
0,8~2,6 mm²
22~10 AWG

7~8 mm
10~22



10~22



Prensar • Crimp • Sertir

L mm	Part N°	€
200	296-058	8,25

296

Cortacables Profesional

Professional Wire Cutter • Coupe-Câbles Professionnel



Pelar
Strip • Dénuder
0,6~2,6 mm²
22~10 AWG

Cortar
Cut • Couper



L mm	Part N°	€
200	296-059	7,48

Juegos en Bandeja Combinable • EVA Foam Tray Sets • Jeux en Panneau de Mousse Modulable

200

Alta Potencia
High Leverage • Haute Performance

4
Pcs

CrV

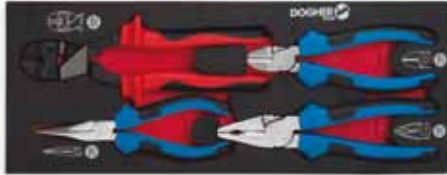

1/4 (375 x 140 x 30 mm)



Part N°	€
200-080	122,97

205

Profesionales
Professional • Professionnelles

4
Pcs

CrV



1/4 (375 x 140 x 30 mm)



Part N°	€
205-080	79,78

205

Profesionales
Professional • Professionnelles

4
Pcs

CrV



1/3 (375 x 188 x 30 mm)



Part N°	€
205-081	95,90

220

Arandelas Seeger
Circlip® Pliers • Pinces Circlip®

4
Pcs

CrV



1/4 (375 x 140 x 30 mm)



Part N°	€
220-080	86,48

225

Mini-Alicates
Mini-Pliers • Mini-Pinces

4
Pcs

CrV



1/4 (375 x 140 x 30 mm)



Part N°	€
225-080	63,48

237

Mini-Alicates ESD
ESD Mini-Pliers • Mini-Pinces ESD

4
Pcs

CrV



1/4 (375 x 140 x 30 mm)



Part N°	€
237-080	69,48

Juegos en Bandeja Combinable • EVA Foam Tray Sets • Jeux en Panneau de Mousse Modulable

250

Aislados 1000V
Insulated 1000V • Isolées 1000V

3
Pcs

CrV



1/4 (375 x 140 x 30 mm)



160mm 160mm 180mm

Part N°	€
250-080	90,80

250

Aislados 1000V
Insulated 1000V • Isolées 1000V

4
Pcs

CrV



1/3 (375 x 188 x 30 mm)



160mm 180mm 240mm 160mm

Part N°	€
250-081	131,58

276

Tenazas Grip
Locking Pliers • Pincettes-Étaux

3
Pcs

CrMo



1/4 (375 x 140 x 30 mm)

125mm • 175mm • 250mm

Part N°	€
276-080	62,75

296

Bandeja para Electricista
Electrician Tray • Panneau Électricien

3
Pcs

CrV



1/3 (375 x 188 x 30 mm)

296-056 296-051 296-002

Part N°	€
296-080	57,93

Ver Información Ampliada sobre Almacenaje y Bandejas Combinables en Páginas:

Further Information about Storage and EVA Foam Trays in Pages:

Voir pour Plus d'information sur le Rangement et Panneaux de Mousse Modulables Pages:

10 • 11

Destornilladores
Screwdrivers
Tournevis



<i>iPlus</i>		88
<i>ind</i>		92
<i>Prof</i>		96
<i>Std</i>		105
		109
		113
		116
		118
		119
		124
		125
		128

Serie **Industrial Plus** • **Industrial Plus Series** • Série **Industrielle Plus**



300

Boca Recta • Milled • Electricien



A mm	B mm	L mm		Part N°	€
2,5	0,4	100	10	300-025-100	8,86
3	0,5	100	10	300-030-100	8,86
3,5	0,6	100	10	300-035-100	8,86
4	0,8	125	10	300-040-125	9,51
5	1	125	10	300-050-125	9,58
6	1,2	150	10	300-060-150	9,63

301

Boca Phillips • Phillips • Phillips



	L mm		Part N°	€
PH0	75	10	301-PH0-075	8,63
PH1	100	10	301-PH1-100	8,98
PH2	125	10	301-PH2-125	9,98
PH3	150	10	301-PH3-150	12,30

Serie **Industrial Plus** • **Industrial Plus Series** • Série **Industrielle Plus**

301

Boca Phillips Serie Extra Larga • *Phillips Extra Long Series* • *Phillips Série Extra Longue*



	L mm		Part N°	€
PH2	300	10	301-PH2-300	13,61
PH3	300	10	301-PH3-300	14,68

302

Boca Pozidriv • *Pozidriv* • *Pozidriv*



	L mm		Part N°	€
PZ0	75	10	302-PZ0-075	8,63
PZ1	100	10	302-PZ1-100	8,98
PZ2	125	10	302-PZ2-125	9,98
PZ3	150	10	302-PZ3-150	12,30

303

Boca Torx • *Torx* • *Torx*



	L mm		Part N°	€
T6	50	10	303-T06	6,71
T7	50	10	303-T07	6,71
T8	60	10	303-T08	6,71
T9	60	10	303-T09	6,71
T10	80	10	303-T10	6,88
T15	80	10	303-T15	6,88
T20	100	10	303-T20	7,25
T25	100	10	303-T25	8,01
T27	115	10	303-T27	8,01
T30	115	10	303-T30	9,13
T40	130	10	303-T40	9,87
T45	130	10	303-T45	12,29
T50	150	10	303-T50	13,08

Juegos Serie Industrial Plus • Industrial Plus Series Sets • Jeux Série Industrielle Plus

300

Caja de Cartón
Carton Box • Étui Carton

6

Pcs



S2



Recta
Milled
Electricien

3 • 4 • 5 • 6

PH1 • PH2



300

Caja de Cartón
Carton Box • Étui Carton

6

Pcs



S2



Recta
Milled
Electricien

3 • 4 • 5 • 6

PZ1 • PZ2



Part N°

€

300-001

60,27

Part N°

€

300-002

60,27

300

Bandeja Combinable
EVA Foam Tray • Panneau de Mousse Modulable

6

Pcs



S2



1/4 (375 x 140 x 30 mm)

Recta
Milled
Electricien

3 • 4 • 5 • 6

PH1 • PH2



300

Bandeja Combinable
EVA Foam Tray • Panneau de Mousse Modulable

6

Pcs



S2

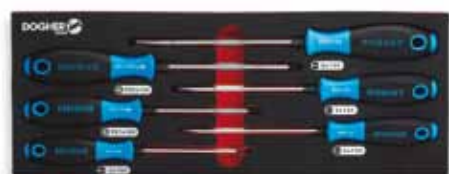

1/4 (375 x 140 x 30 mm)

Recta
Milled
Electricien

3 • 4 • 5 • 6

PZ1 • PZ2



Part N°

€

300-080

62,89

Part N°

€

300-081

62,89

Juegos Serie Industrial Plus • Industrial Plus Series Sets • Jeux Série Industrielle Plus

303

Caja de Cartón

Carton Box • Étui Carton

6

Pcs



S2



T10 • T15 • T20 • T25 • T30 • T40

Part N°	€
303-001	51,76

303

Bandeja Combinable

EVA Foam Tray • Panneau de Mousse Modulable

6

Pcs



S2

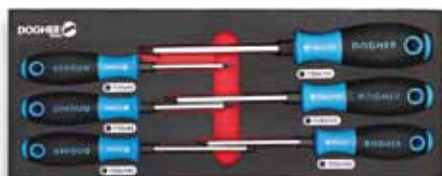

1/4 (375 x 140 x 30 mm)



T10 • T15 • T20 • T25 • T30 • T40

Part N°	€
303-080	54,38

Ver Información Ampliada sobre Almacenaje y Bandejas Combinables en Páginas:

Further Information about Storage and EVA Foam Trays in Pages:

Voir pour Plus d'information sur le Rangement et Panneaux de Mousse Modulables Pages:

10 • 11

Serie **Industrial** • **Industrial** Series • Série **Industrielle**



Hexágono Conductor
Hex Bolster
Prise 6 Pans

Mango Bimaterial
Bimaterial Handle
Manche Bi-matière



Varilla Circular
Round Blade
Lame Cylindrique

CrMo 56HRC

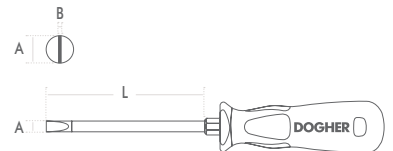

315

Boca Recta • Milled • Electricien



A mm	B mm	L mm		Part N°	€
5,5	1	125	10	315-055-125	7,51
6,5	1,2	150	10	315-065-150	8,76
8	1,2	175	10	315-080-175	11,26
10	1,6	200	10	315-100-200	12,03

316

Boca Plana • Stamped • Mécanicien



A mm	B mm	L mm		Part N°	€
5,5	1	125	10	316-055-125	7,51
6,5	1,2	150	10	316-065-150	8,76
8	1,2	175	10	316-080-175	11,26
10	1,6	200	10	316-100-200	12,03

Serie **Industrial** • **Industrial Series** • Série **Industrielle**

317

Boca Phillips • Phillips • Phillips



CrMo



	L mm		Part N°	€
PH1	100	10	317-PH1-100	6,59
PH2	125	10	317-PH2-125	7,69
PH3	150	10	317-PH3-150	11,21
PH4	200	10	317-PH4-200	15,88

318

Boca Pozidriv • Pozidriv • Pozidriv



CrMo



	L mm		Part N°	€
PZ1	100	10	318-PZ1-100	6,59
PZ2	125	10	318-PZ2-125	7,69
PZ3	150	10	318-PZ3-150	11,21
PZ4	200	10	318-PZ4-200	15,88

319

Boca Torx Seguridad • Torx Tamper • Torx Sécurité



S2



	L mm		Part N°	€
TS7	50	10	319-TS07	9,85
TS8	60	10	319-TS08	9,85
TS9	60	10	319-TS09	9,85
TS10	80	10	319-TS10	9,85
TS15	80	10	319-TS15	10,51
TS20	100	10	319-TS20	10,51
TS25	100	10	319-TS25	11,53
TS27	115	10	319-TS27	11,53
TS30	115	10	319-TS30	15,09
TS40	130	10	319-TS40	15,24
TS45	130	10	319-TS45	16,95
TS50	150	10	319-TS50	18,75

Serie **Industrial** • **Industrial** Series • Série **Industrielle**

321

Boca Hexagonal • Hexagonal • Hexagonal



CrMo



	L mm		Part N°	€
HX2	100	10	321-HX020-100	7,78
HX2,5	100	10	321-HX025-100	7,78
HX3	100	10	321-HX030-100	8,03
HX4	100	10	321-HX040-100	8,03
HX5	100	10	321-HX050-100	8,03
HX6	125	10	321-HX060-125	8,16
HX8	150	10	321-HX080-150	10,77

322

Vaso Hexagonal • Hexagonal Nut • Douille Hexagonale



CrV



	L mm		Part N°	€
4	125	10	322-040-125	9,00
4,5	125	10	322-045-125	9,00
5	125	10	322-050-125	9,50
5,5	125	10	322-055-125	9,50
6	125	10	322-060-125	9,50
7	125	10	322-070-125	9,83
8	125	10	322-080-125	9,83
9	125	10	322-090-125	10,01
10	125	10	322-100-125	10,34
11	125	10	322-110-125	12,23
12	125	10	322-120-125	12,95
13	125	10	322-130-125	13,16

323

Boca Robertson • Robertson • Robertson



CrMo



	L mm		Part N°	€
R1	100	10	323-R1	7,59
R2	125	10	323-R2	8,36
R3	150	10	323-R3	10,25

Juegos Serie Industrial • Industrial Series Sets • Jeux Série Industrielle

315

Estuche de Plástico
Plastic Box • Coffret Plastique

5

Pcs



CrMo



Recta
Milled
Electricien

5,5 • 6,5

PH1 • PH2 • PH3



Part N°

€

315-001

47,26

315

Estuche de Plástico
Plastic Box • Coffret Plastique

5

Pcs



CrMo



Recta
Milled
Electricien

5,5 • 6,5

PZ1 • PZ2 • PZ3



Part N°

€

315-002

47,26

315

Bandeja Combinable
EVA Foam Tray • Panneau de Mousse Modulable

5

Pcs



CrMo

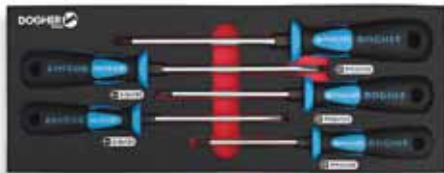

1/4 (375 x 140 x 30 mm)

Recta
Milled
Electricien

5,5 • 6,5

PH1 • PH2 • PH3



Part N°

€

315-080

48,14

315

Bandeja Combinable
EVA Foam Tray • Panneau de Mousse Modulable

5

Pcs



CrMo

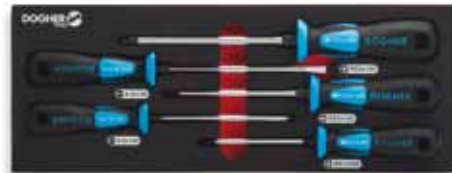

1/4 (375 x 140 x 30 mm)

Recta
Milled
Electricien

5,5 • 6,5

PZ1 • PZ2 • PZ3



Part N°

€

315-081

48,14

319

Caja de Cartón • Carton Box • Étui Carton

6

Pcs



S2



TS10 • TS15 • TS20 • TS25 • TS30 • TS40

Part N°

€

319-001

76,47

Ver Información Ampliada de las bandejas Combinables

Further Information about EVA Foam Trays • Voir pour Plus d'information de Panneaux Modulables

p. 10 • 11

Destornilladores • Screwdrivers • Tournevis

Serie **Profesional** • **Professional Series** • Série **Professionnelle**



Mango Bimaterial
Bimaterial Handle
Manche Bi-matière



Varilla Circular
Round Blade
Lame Cylindrique

CrMo 56HRC

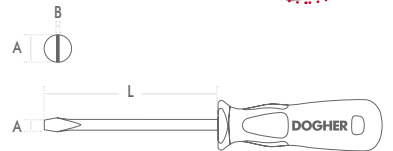

330

Boca Plana • Stamped • Mécanicien



CrMo

A mm	B mm	L mm		Part N°	€
2,5	0,4	75	10	330-025-075	3,78
3	0,5	75	10	330-030-075	4,28
4	0,8	75	10	330-040-075	4,63
4	0,8	100	10	330-040-100	4,78
5,5	1	100	10	330-055-100	4,98
5,5	1	125	10	330-055-125	5,20
6,5	1,2	125	10	330-065-125	6,44
6,5	1,2	150	10	330-065-150	6,63
8	1,2	150	10	330-080-150	8,39
8	1,2	175	10	330-080-175	7,80
10	1,6	200	10	330-100-200	10,78

Serie **Profesional** • Professional Series • Série **Professionnelle**

331

Boca Recta • Milled • Electricien



A mm	B mm	L mm		Part N°	€
2,5	0,4	75	10	331-025-075	3,35
3	0,5	75	10	331-030-075	3,50
3	0,5	100	10	331-030-100	4,20
3,5	0,6	100	10	331-035-100	4,31
4	0,8	100	10	331-040-100	4,53
4	0,8	125	10	331-040-125	4,75
5,5	1	125	10	331-055-125	5,06
5,5	1	150	10	331-055-150	5,35
6,5	1,2	150	10	331-065-150	6,39

331

Boca Recta Serie Extra Larga • Milled Extra Long Series • Electricien Série Extra Longue



A mm	B mm	L mm		Part N°	€
3	0,5	200	10	331-030-200	6,63
4	0,8	250	10	331-040-250	9,65
5,5	1	300	10	331-055-300	11,08
6,5	1,2	300	10	331-065-300	12,50

331

Boca Recta Serie Extra Corta • Milled Extra Short Series • Electricien Série Extra Courte



A mm	B mm	L mm		Part N°	€
5,5	1	25	20	331-055-025	4,75
6,5	1,2	25	20	331-065-025	5,60

Serie **Profesional** • **Professional Series** • Série **Professionnelle**

334

Boca Phillips • Phillips • Phillips



CrMo



	L mm		Part N°	€
PH0	75	10	334-PH0-075	3,50
PH1	100	10	334-PH1-100	4,78
PH2	125	10	334-PH2-125	5,58
PH3	150	10	334-PH3-150	8,13
PH4	200	10	334-PH4-200	14,38

334

Boca Phillips Serie Extra Larga • Phillips Extra Long Series • Phillips Série Extra Longue



CrMo



	L mm		Part N°	€
PH0	200	10	334-PH0-200	6,27
PH1	250	10	334-PH1-250	9,53
PH2	300	10	334-PH2-300	11,35

334

Boca Phillips Serie Extra Corta • Phillips Extra Short Series • Phillips Série Extra Courte



CrMo



	L mm		Part N°	€
PH1	25	20	334-PH1-025	5,66
PH2	25	20	334-PH2-025	5,84

Serie **Profesional** • **Professional Series** • Série **Professionnelle**

337

Boca Pozidriv • Pozidriv • Pozidriv



	L mm		Part N°	€
PZ0	75	10	337-PZ0-075	4,11
PZ1	100	10	337-PZ1-100	5,07
PZ2	125	10	337-PZ2-125	5,90
PZ3	150	10	337-PZ3-150	8,95

337

Boca Pozidriv Serie Extra Larga • Pozidriv Extra Long Series • Pozidriv Série Extra Longue



	L mm		Part N°	€
PZ0	200	10	337-PZ0-200	8,40
PZ1	250	10	337-PZ1-250	9,78
PZ2	300	10	337-PZ2-300	11,35

337

Boca Pozidriv Serie Extra Corta • Pozidriv Extra Short Series • Pozidriv Série Extra Courte



	L mm		Part N°	€
PZ1	25	20	337-PZ1-025	5,66
PZ2	25	20	337-PZ2-025	5,84

Destornilladores • Screwdrivers • Tournevis

 Serie **Profesional** • **Professional Series** • Série **Professionnelle**
340

Boca Torx • Torx • Torx

S2

	L mm		Part N°	€
T4	50	10	340-T04	5,18
T5	50	10	340-T05	5,18
T6	50	10	340-T06	5,18
T7	50	10	340-T07	5,18
T8	60	10	340-T08	5,18
T9	60	10	340-T09	5,18
T10	80	10	340-T10	5,47
T15	80	10	340-T15	5,83
T20	100	10	340-T20	5,83
T25	100	10	340-T25	6,48
T27	115	10	340-T27	6,48
T30	115	10	340-T30	8,25
T40	130	10	340-T40	8,59
T50	150	10	340-T50	11,33

341

Boca Torx Seguridad • Torx Tamper • Torx Sécurité

S2

	L mm		Part N°	€
TS10	80	10	341-TS10	7,96
TS15	80	10	341-TS15	8,08
TS20	100	10	341-TS20	8,08
TS25	100	10	341-TS25	8,87
TS27	115	10	341-TS27	8,87
TS30	115	10	341-TS30	11,61
TS40	130	10	341-TS40	11,73
TS45	130	10	341-TS45	13,04

342

Boca Hexagonal • Hexagonal • Hexagonal

CrMo



	L mm		Part N°	€
HR5	100	10	342-HR050-100	6,49
HR6	125	10	342-HR060-125	7,81
HR8	150	10	342-HR080-150	11,22

Serie **Profesional** • **Professional Series** • Série **Professionnelle**

343

Portapuntas Magnético • Magnetic Bit Holder • Porte-Embouts Magnétique





	L mm		Part N°	€
1/4"	100	10	343-001	10,21

343

Portapuntas Flexible • Flexible Hose Clamp • Porte-Embouts Flexible



	L mm		Part N°	€
1/4"	200	10	343-002	12,04

343

Dedo Magnético • Magnetic Finger • Doigt Magnétique





L mm		Part N°	€
440	10	343-003	25,81

343

Destornillador con Cuadradillo para Vasos • Spinner Handle for Sockets • Tournevis avec Carré pour Douilles



	L mm		Part N°	€
1/4"	50	10	343-004	8,00



Serie **Profesional** • **Professional Series** • Série **Professionnelle**

343 Destornillador Flexible de Largo Alcance
Long Reach Flexible Screwdriver • Tournevis Flexible Longue Portée

1/4"

CrV



	L mm		Part N°	€
1/4"	500	10	343-005	20,43





343 Destornillador Extra Corto Reversible de Carraca
Extra Short Reversible Ratcheting Screwdriver • Tournevis Extra Court à Cliquet Réversible

1/4"

CrV



	L mm		Part N°	€
1/4"	110	10	343-006	10,50





343 Destornillador Articulado de Carraca con Bola de Retención
Flexible Ratcheting Screwdriver • Tournevis Articulé à Cliquet à Bille de Maintien

1/4"

CrV



	L mm		Part N°	€
1/4"	180	10	343-007	16,25



Juegos Serie Profesional • Professional Series Sets • Jeux Série Professionnelle

330

Estuche de Plástico
Plastic Box • Coffret Plastique

5

Pcs



Plana
Stamped
Mécanicien

5,5 • 6,5

PH1 • PH2 • PH3



Part N°

€

330-001

35,62

330

Estuche de Plástico
Plastic Box • Coffret Plastique

7

Pcs



Plana
Stamped
Mécanicien

3 • 4 • 5,5 • 6,5

PH0 • PH1 • PH2



Part N°

€

330-003

40,23

330

Estuche de Plástico
Plastic Box • Coffret Plastique

5

Pcs



Plana
Stamped
Mécanicien

5,5 • 6,5

PZ1 • PZ2 • PZ3



Part N°

€

330-002

37,06

330

Estuche de Plástico
Plastic Box • Coffret Plastique

7

Pcs



Plana
Stamped
Mécanicien

3 • 4 • 5,5 • 6,5

PZ0 • PZ1 • PZ2



Part N°

€

330-004

41,46

Destornilladores • Screwdrivers • Tournevis

Juegos Serie Profesional • Professional Series Sets • Jeux Série Professionnelle

330

Bandeja Combinable
EVA Foam Tray • Panneau de Mousse Modulable

5
Pcs

CrMo

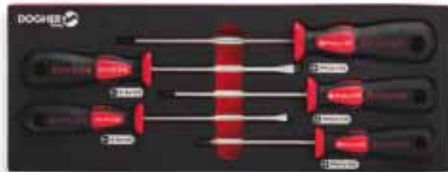

1/4 (375 x 140 x 30 mm)

Plana
Stamped
Mécanicien



5,5 • 6,5

PH1 • PH2 • PH3



Part N°	€
330-080	36,49

330

Bandeja Combinable
EVA Foam Tray • Panneau de Mousse Modulable

7
Pcs

CrMo

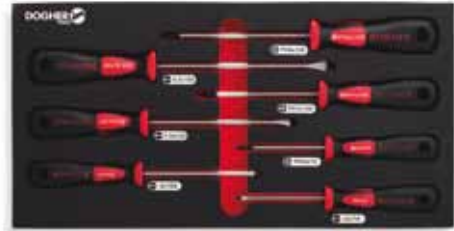

1/3 (375 x 188 x 30 mm)

Plana
Stamped
Mécanicien



3 • 4 • 5,5 • 6,5

PH0 • PH1 • PH2



Part N°	€
330-082	43,86

330

Bandeja Combinable
EVA Foam Tray • Panneau de Mousse Modulable

5
Pcs

CrMo



1/4 (375 x 140 x 30 mm)

Plana
Stamped
Mécanicien



5,5 • 6,5

PZ1 • PZ2 • PZ3



Part N°	€
330-081	37,93

330

Bandeja Combinable
EVA Foam Tray • Panneau de Mousse Modulable

7
Pcs

CrMo

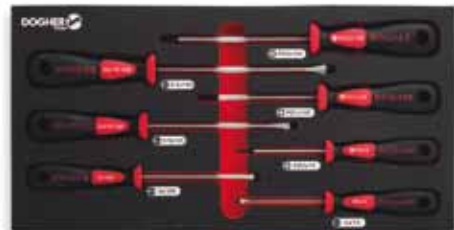

1/3 (375 x 188 x 30 mm)

Plana
Stamped
Mécanicien



3 • 4 • 5,5 • 6,5

PZ0 • PZ1 • PZ2



Part N°	€
330-083	45,08

Ver Información Ampliada • Further Information • Voir pour Plus d'information

p. 10 • 11

340

Caja de Cartón • Carton Box • Étui Carton

6
Pcs



S2



T10 • T15 • T20 • T25 • T30 • T40

Part N°	€
340-001	44,19

Serie **Standard** • **Standard** Series • Série **Standard**



345 Boca Plana • Stamped • Mécanicien



A mm	B mm	L mm		Part N°	€
3	0,5	75	10	345-030-075	3,14
4	0,8	75	10	345-040-075	3,43
4	0,8	100	10	345-040-100	3,61
5,5	1	100	10	345-055-100	3,84
5,5	1	125	10	345-055-125	4,42
6,5	1,2	125	10	345-065-125	5,80
8	1,2	150	10	345-080-150	6,77
8	1,2	175	10	345-080-175	7,34
10	1,6	200	10	345-100-200	8,58

346 Boca Recta • Milled • Electricien



A mm	B mm	L mm		Part N°	€
2,5	0,4	75	10	346-025-075	3,16
3	0,5	75	10	346-030-075	3,26
3	0,5	100	10	346-030-100	3,28
3,5	0,6	100	10	346-035-100	3,28
4	0,8	100	10	346-040-100	4,20
4	0,8	125	10	346-040-125	4,33
5,5	1	125	10	346-055-125	5,02
5,5	1	150	10	346-055-150	5,13
6,5	1,2	150	10	346-065-150	6,29

Serie **Standard** • **Standard Series** • Série **Standard**

346

Boca Recta Serie Extra Larga • Milled Extra Long Series • Electricien Série Extra Longue



A mm	B mm	L mm		Part N°	€
3	0,5	200	10	346-030-200	6,25
4	0,8	250	10	346-040-250	6,78
5,5	1	300	10	346-055-300	7,53
6,5	1,2	300	10	346-065-300	9,18

346

Boca Recta Serie Extra Corta • Milled Extra Short Series • Electricien Série Extra Courte



A mm	B mm	L mm		Part N°	€
5,5	1	25	10	346-055-025	4,62
6,5	1,2	25	10	346-065-025	5,13

347

Boca Phillips • Phillips • Phillips



	L mm		Part N°	€
PH0	75	10	347-PH0-075	3,38
PH1	100	10	347-PH1-100	4,08
PH2	150	10	347-PH2-150	4,83
PH3	150	10	347-PH3-150	7,75
PH4	200	10	347-PH4-200	11,48

Serie **Standard** • **Standard** Series • Série **Standard**

347

Boca Phillips Serie Extra Larga • Phillips Extra Long Series • Phillips Série Extra Longue



	L mm		Part N°	€
PH0	200	10	347-PH0-200	6,21
PH1	250	10	347-PH1-250	6,49
PH2	300	10	347-PH2-300	8,04

347

Boca Phillips Serie Extra Corta • Phillips Extra Short Series • Phillips Série Extra Courte



	L mm		Part N°	€
PH1	25	10	347-PH1-025	4,45
PH2	25	10	347-PH2-025	4,83

348

Boca Pozidriv • Pozidriv • Pozidriv



	L mm		Part N°	€
PZ0	75	10	348-PZ0-075	3,38
PZ1	100	10	348-PZ1-100	4,08
PZ2	125	10	348-PZ2-125	4,83
PZ3	150	10	348-PZ3-150	7,75

Serie **Standard** • **Standard Series** • Série **Standard**
348

Boca Pozidriv Serie Extra Larga • Pozidriv Extra Long Series • Pozidriv Série Extra Longue



	L mm		Part N°	€
PZ0	200	10	348-PZ0-200	6,83
PZ1	250	10	348-PZ1-250	7,14
PZ2	300	10	348-PZ2-300	8,85

348

Boca Pozidriv Serie Extra Corta • Pozidriv Extra Short Series • Pozidriv Série Extra Courte



	L mm		Part N°	€
PZ1	25	10	348-PZ1-025	4,45
PZ2	25	10	348-PZ2-025	4,83

349

Boca Torx • Torx • Torx



	L mm		Part N°	€
T4	75	10	349-T04	4,76
T5	75	10	349-T05	4,76
T6	75	10	349-T06	4,76
T7	75	10	349-T07	4,76
T8	75	10	349-T08	4,76
T9	75	10	349-T09	4,76
T10	75	10	349-T10	5,05
T15	100	10	349-T15	5,05
T20	100	10	349-T20	5,05
T25	125	10	349-T25	5,86
T27	125	10	349-T27	5,96
T30	150	10	349-T30	6,85
T40	150	10	349-T40	7,94
T50	175	10	349-T50	9,11

Serie Profesional Mango Antideslizante • Anti-Slip Handle Professional Series • Série Professionnelle Manche Anti-glisse



Mango Antideslizante
Anti-Slip Handle
Manche Anti-glisse



Varilla Circular
Round Blade
Lame Cylindrique

CrMo 56HRC

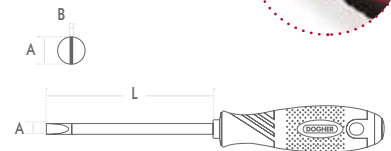

351

Boca Recta • Milled • Electricien



CrMo



A mm	B mm	L mm		Part N°	€
3	0,5	100	10	351-030-100	5,03
4	0,8	125	10	351-040-125	5,23
5,5	1	150	10	351-055-150	6,40
6,5	1,2	150	10	351-065-150	8,15

351

Boca Recta Serie Extra Larga • Milled Long Series • Electricien Série Extra Longue



CrMo

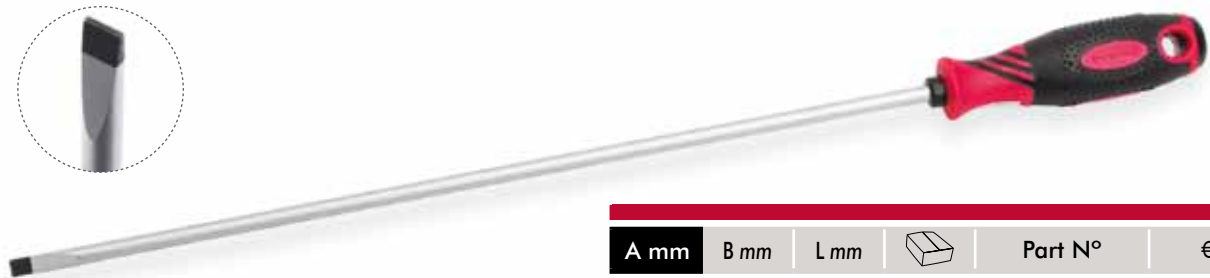

A mm	B mm	L mm		Part N°	€
3	0,5	200	10	351-030-200	8,15
4	0,8	250	10	351-040-250	11,87
5,5	1	300	10	351-055-300	13,62
6,5	1,2	300	10	351-065-300	15,38

Destornilladores • Screwdrivers • Tournevis

Serie Profesional Mango Antideslizante • Anti-Slip Handle Professional Series • Série Professionnelle Manche Anti-glisse

352

Boca Phillips • Phillips • Phillips



	L mm		Part N°	€
PH0	75	10	352-PH0-075	4,31
PH1	100	10	352-PH1-100	5,72
PH2	125	10	352-PH2-125	6,64
PH3	150	10	352-PH3-150	9,99

352

Boca Phillips Serie Extra Larga • Phillips Extra Long Series • Phillips Série Extra Longue



	L mm		Part N°	€
PH0	200	10	352-PH0-200	7,71
PH1	250	10	352-PH1-250	12,02
PH2	300	10	352-PH2-300	13,96

353

Boca Pozidriv • Pozidriv • Pozidriv



	L mm		Part N°	€
PZ0	75	10	353-PZ0-075	5,05
PZ1	100	10	353-PZ1-100	6,24
PZ2	125	10	353-PZ2-125	7,25
PZ3	150	10	353-PZ3-150	11,01

Serie Profesional Mango Antideslizante • Anti-Slip Handle Professional Series • Série Professionnelle Manche Anti-glisser

353

Boca Pozidriv Serie Extra Larga • Pozidriv Extra Long Series • Pozidriv Série Extra Longue



CrMo



	L mm		Part N°	€
PZ1	250	10	353-PZ1-250	12,02
PZ2	300	10	353-PZ2-300	13,96

354

Boca Torx • Torx • Torx



S2



	L mm		Part N°	€
T6	50	10	354-T06	6,37
T7	50	10	354-T07	6,37
T8	60	10	354-T08	6,37
T9	60	10	354-T09	6,37
T10	80	10	354-T10	6,73
T15	80	10	354-T15	7,17
T20	100	10	354-T20	7,17
T25	100	10	354-T25	7,97
T27	115	10	354-T27	7,97
T30	115	10	354-T30	10,14
T40	130	10	354-T40	10,56
T45	130	10	354-T45	13,30
T50	150	10	354-T50	14,40

Juegos Serie Profesional Antideslizante • Anti-Slip Professional Series Sets • Jeux Série Professionnelle Anti-glisse

351

Estuche de Plástico
Plastic Box • Coffret Plastique

6

Pcs



Recta
Milled
Electricien

3 • 4 • 5,5 • 6,5

PH1 • PH2



Part N°

€

351-001

42,66

351

Estuche de Plástico
Plastic Box • Coffret Plastique

6

Pcs



Recta
Milled
Electricien

3 • 4 • 5,5 • 6,5

PZ1 • PZ2



Part N°

€

351-002

43,79

351

Bandeja Combinable
EVA Foam Tray • Panneau de Mousse Modulable

6

Pcs

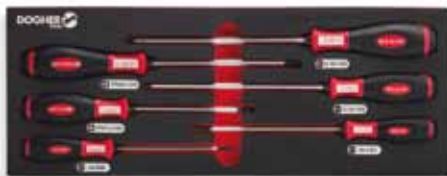

1/4 (375 x 140 x 30 mm)

Recta
Milled
Electricien

3 • 4 • 5,5 • 6,5

PH1 • PH2



Part N°

€

351-080

43,53

351

Bandeja Combinable
EVA Foam Tray • Panneau de Mousse Modulable

6

Pcs

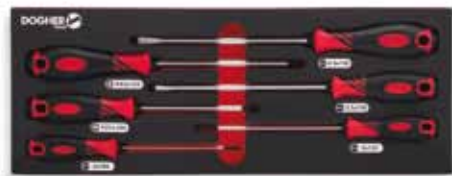

1/4 (375 x 140 x 30 mm)

Recta
Milled
Electricien

3 • 4 • 5,5 • 6,5

PZ1 • PZ2



Part N°

€

351-081

44,66

Ver Información Ampliada sobre Almacenaje y Bandejas Combinables en Páginas:

Further Information about Storage and EVA Foam Trays in Pages:

Voir pour Plus d'information sur le Rangement et Panneaux de Mousse Modulables Pages:

10 • 11

Aislados Serie Profesional • Insulated Professional Series • Isolés Série Professionnelle

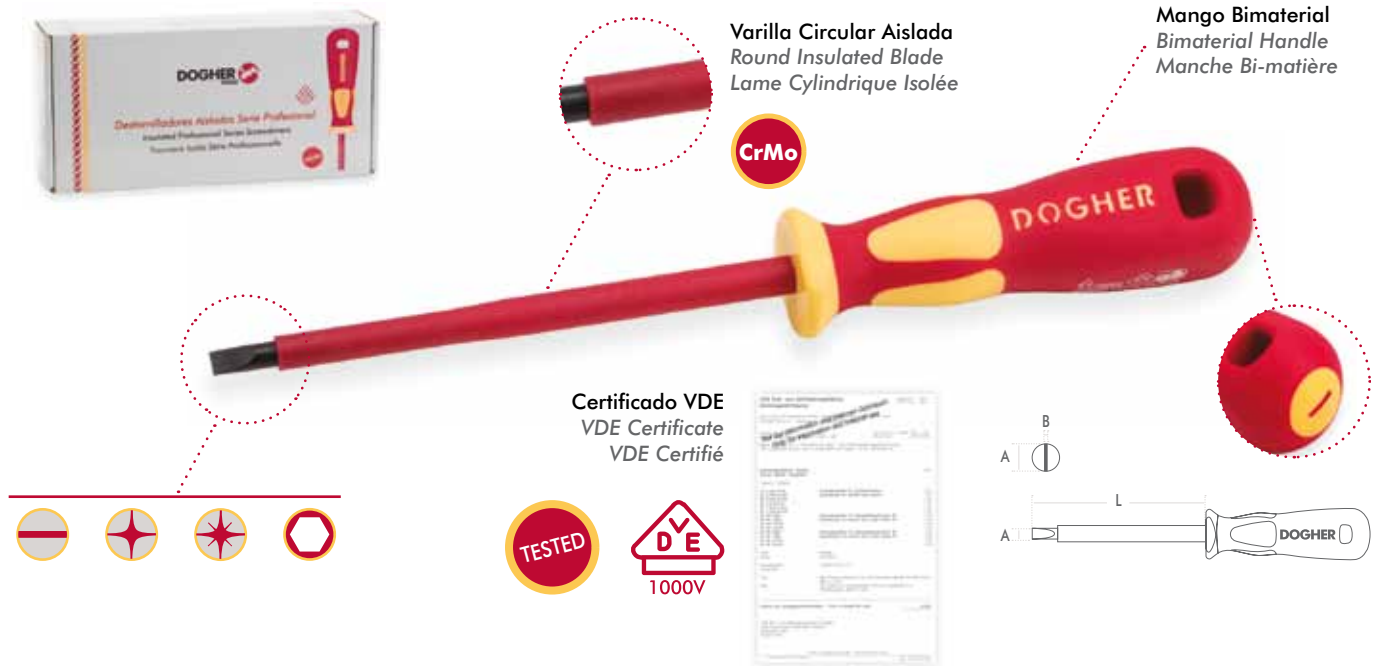

360

Boca Recta • Milled • Electricien



A mm	B mm	L mm		Part N°	€
2,5	0,4	75	10	360-025-075	5,71
3	0,5	100	10	360-030-100	6,26
4	0,8	100	10	360-040-100	6,76
5,5	1	125	10	360-055-125	9,54
6,5	1,2	150	10	360-065-150	10,58
8	1,6	175	10	360-080-175	11,75

361

Boca Phillips • Phillips • Phillips



	L mm		Part N°	€
PH0	60	10	361-PH0-060	6,38
PH1	80	10	361-PH1-080	7,94
PH2	100	10	361-PH2-100	9,98
PH3	150	10	361-PH3-150	13,03

Aislados Serie Profesional • Insulated Professional Series • Isolés Série Professionnelle

362

Boca Pozidriv • Pozidriv • Pozidriv



	L mm		Part N°	€
PZ0	60	10	362-PZ0-060	6,38
PZ1	80	10	362-PZ1-080	7,94
PZ2	100	10	362-PZ2-100	10,46
PZ3	150	10	362-PZ3-150	14,35

364

Vaso Hexagonal • Hex Nut • Douille Hexagonale

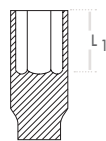

	L mm	L ₁ mm		Part N°	€
4	125	5	10	364-04	13,64
5	125	26	10	364-05	13,64
6	125	26	10	364-06	13,64
7	125	26	10	364-07	14,96
8	125	26	10	364-08	15,29
9	125	26	10	364-09	16,01
10	125	26	10	364-10	16,50
11	125	26	10	364-11	17,80
12	125	26	10	364-12	20,24
13	125	26	10	364-13	22,33

Juegos Serie Profesional Aislados • Insulated Professional Series Sets • Jeux Isolés Série Professionnelle

364

Estuche de Plástico
Plastic Box • Coffret Plastique

6
Pcs



5 • 6 • 8 • 9 • 10 • 12

Part N°	€
364-001	97,57

Juegos Serie Profesional Aislados • Insulated Professional Series Sets • Jeux Isolés Série Professionnelle

360

Estuche de Plástico
Plastic Box • Coffret Plastique

7
Pcs



3 • 4 • 5,5 • 6,5

PH0 • PH1 • PH2



Part N°

€

360-001

62,93

360

Estuche de Plástico
Plastic Box • Coffret Plastique

7
Pcs



3 • 4 • 5,5 • 6,5

PZ0 • PZ1 • PZ2



Part N°

€

360-002

63,41

360

Bandeja Combinable
EVA Foam Tray • Panneau de Mousse Modulable

7
Pcs



1/4 (375 x 140 x 30 mm)

3 • 4 • 5,5 • 6,5

PH0 • PH1 • PH2



Part N°

€

360-080

63,80

360

Bandeja Combinable
EVA Foam Tray • Panneau de Mousse Modulable

7
Pcs



1/4 (375 x 140 x 30 mm)

3 • 4 • 5,5 • 6,5

PZ0 • PZ1 • PZ2



Part N°

€

360-081

64,29

330

Bandeja Combinable
EVA Foam Tray • Panneau de Mousse Modulable

10
Pcs



1/3 (375 x 188 x 30 mm)

Recta
Milled
Electricien

4 • 5,5 • 6,5

PH1 • PH2



Plana
Stamped
Mécanicien

4 • 5,5 • 6,5

PH1 • PH2



Part N°

€

330-084

80,86

Aislados de Precisión Serie Profesional • Insulated Precision Professional Series • Isolés de Précision Série Professionnelle



Varilla Circular Aislada
Round Insulated Blade
Lame Cylindrique Isolée

CrMo

Mango Bimaterial
Bimaterial Handle
Manche Bi-matière



Certificado VDE
VDE Certificate
VDE Certifié

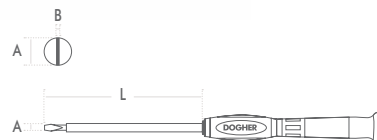

365

Boca Recta • Milled • Electricien



TESTED

CrMo



A mm	B mm	L mm		Part N°	€
1,5	0,4	65	10	365-015-065	6,70
2	0,4	65	10	365-020-065	6,70
2,5	0,4	65	10	365-025-065	6,70
3	0,5	65	10	365-030-065	6,70

366

Boca Phillips • Phillips • Phillips



TESTED

CrMo



	L mm		Part N°	€
PH00	65	10	366-PH00-065	6,70
PH0	65	10	366-PH0-065	6,70
PH1	65	10	366-PH1-065	6,70

Juegos - Aislados de Precisión • Insulated Precision - Sets • Jeux - Isolés de Précision

365

Estuche de Plástico • Plastic Box • Coffret Plastique

6

Pcs



2 • 2,5 • 3

PH00 • PH0 • PH1



Part N°

€

365-001

45,20

365

Estuche de Plástico • Plastic Box • Coffret Plastique

7

Pcs



1,5 • 2 • 2,5 • 3

PH00 • PH0 • PH1



Part N°

€

365-002

51,90

Destornilladores • Screwdrivers • Tournevis

Pasante Serie Profesional • Go-through Professional Series • Lame Traversante Série Professionnelle



Hexágono Conductor
Hex Bolster
Prise 6 Pans

Mango Bimaterial
Bimaterial Handle
Manche Bi-matière



Varilla Hexagonal
Hex Blade
Lame Hexagonale

S2 58HRC

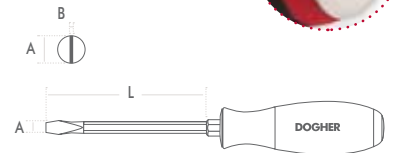

375

Boca Plana • Stamped • Mécanicien



S2



A mm	B mm	L mm		Part N°	€
5,5	1	100	10	375-055-100	9,59
6,5	1,2	125	10	375-065-125	12,22
8	1,2	150	10	375-080-150	13,25
10	1,6	175	10	375-100-175	15,13

376

Boca Phillips • Phillips • Phillips



S2



	L mm		Part N°	€
PH1	100	10	376-PH1-100	8,58
PH2	125	10	376-PH2-125	9,96
PH3	150	10	376-PH3-150	14,99
PH4	200	10	376-PH4-200	16,68

377

Boca Pozidriv • Pozidriv • Pozidriv



S2



	L mm		Part N°	€
PZ1	100	10	377-PZ1-100	9,36
PZ2	125	10	377-PZ2-125	10,88
PZ3	150	10	377-PZ3-150	16,51

Precisión Serie Profesional • Precision Professional Series • Série Professionnelle de Précision



CrMo 56HRC

380 Boca Recta • Milled • Electricien



A mm	B mm	L mm		Part N°	€
1	0,25	50	10	380-010-050	4,10
1,2	0,25	50	10	380-012-050	4,10
1,5	0,25	50	10	380-015-050	4,10
1,8	0,4	50	10	380-018-050	4,10
2	0,4	50	10	380-020-050	4,10
2,5	0,4	50	10	380-025-050	4,10
3	0,6	50	10	380-030-050	4,10
3,5	0,7	50	10	380-035-050	4,10
4	0,8	50	10	380-040-050	4,10

381 Boca Phillips • Phillips • Phillips



	L mm		Part N°	€
PH000	50	10	381-PH000-050	4,28
PH00	50	10	381-PH00-050	4,10
PH0	50	10	381-PH0-050	4,10
PH1	50	10	381-PH1-050	4,10

Precisión Serie Profesional • Precision Professional Series • Série Professionnelle de Précision
382

Boca Pozidriv • Pozidriv • Pozidriv



CrMo



	L mm		Part N°	€
PZ0	50	10	382-PZ0-050	4,10
PZ1	50	10	382-PZ1-050	4,10

383

Boca Torx Seguridad • Torx Tamper • Torx Sécurité



S2



	L mm		Part N°	€
TS5	50	10	383-TS05	4,10
TS6	50	10	383-TS06	4,10
TS7	50	10	383-TS07	4,10
TS8	50	10	383-TS08	4,10
TS9	50	10	383-TS09	4,10
TS10	50	10	383-TS10	4,10

384

Boca Hexagonal • Hexagonal • Hexagonal



CrMo



	L mm		Part N°	€
HR0,7	50	10	384-HR007	4,10
HR0,9	50	10	384-HR009	4,10
HR1,3	50	10	384-HR013	4,10
HR1,5	50	10	384-HR015	4,10
HR2	50	10	384-HR020	4,10
HR2,5	50	10	384-HR025	4,10



Precisión Serie Profesional • Precision Professional Series • Série Professionnelle de Précision

385 Torx Plus • Torx Plus • Torx Plus



CrMo



	L mm		Part N°	€
TP1*	50	10	385-TP01	5,20
TP5	50	10	385-TP05	5,00
TP6	50	10	385-TP06	5,00

* Apto para • Suitable for • Apte pour





386 Destornillador Vaso • Nut Screwdriver • Tournevis Douille



CrV





	L mm		Part N°	€
1,5	50	10	386-015	6,00
2	50	10	386-020	6,00
2,5	50	10	386-025	5,90
3	50	10	386-030	5,90
3,5	50	10	386-035	5,90
4	50	10	386-040	5,80
4,5	50	10	386-045	5,80
5	50	10	386-050	5,80
5,5	50	10	386-055	5,80
6	50	10	386-060	5,80

399 Tri Wing • Tri Wing • Tri Wing



CrMo



	L mm		Part N°	€
TW000	50	10	399-TW000	4,49
TW00	50	10	399-TW00	4,49
TW0	50	10	399-TW0	4,49
TW1	50	10	399-TW1	4,49

Juegos - Precisión Serie Profesional • Precision Professional Series Sets • Jeux Série Professionnelle de Précision

380

Juego de Destornillador de Precisión para Telefonía Móvil

Precision Cellular Repairing Bit Set • Jeu de Tournevis de Précision pour Téléphonie Mobile

11

Pcs



 T5 • T6

TP1 • TP5 • TP6 

 PH000

TRW1 



Part N°

€

380-004

21,10

380

Juego de Destornillador de Precisión con Puntas

Precision Screwdriver Bit Set • Jeu de Tournevis de Précision avec Embouts

51

Pcs

CrMo



1 • 1,5 • 2 • 2,5 • 3 • 3,5 • 4 

PH000 • PH00 • PH0 • PH1 

PZ000 • PZ00 • PZ0 • PZ1 • PZ2 

T3 • T4 • T5 • T6 • T7
T8 • T9 • T10 • T15 • T20 

TS7 • TS8 • TS9 • TS10 • TS15 • TS20 

HX0,7 • HX0,9 • HX1,3 • HX1,5 • HX2,0
HX2,5 • HX3,0 • HX3,5 • HX4,0 

HS2,0 • HS2,5 • HS3,0 • HS4,0 

HR1,5 • HR2,0 • HR2,5 • HR3,0 • HR4,0 

Part N°

€

380-005

64,15

Juegos - Precisión Serie Profesional • Precision Professional Series Sets • Jeux Série Professionnelle de Précision

380

Estuche de Plástico
Plastic Box • Coffret Plastique

6

Pcs



CrMo



2 • 2,5 • 3 PH00 • PH0 • PH1

Part N°	€
380-001	26,85

380

Estuche de Plástico
Plastic Box • Coffret Plastique

7

Pcs



CrMo



1,5 • 2 • 2,5 • 3 PH00 • PH0 • PH1

Part N°	€
380-002	30,95

380

Estuche de Plástico
Plastic Box • Coffret Plastique

8

Pcs



CrMo



2 • 2,5 • 3 • 3,5 • 4 PH00 • PH0 • PH1

Part N°	€
380-003	35,05

383

Estuche de Plástico
Plastic Box • Coffret Plastique

8

Pcs



S2



TS05 • TS06 • TS07 • TS08 • TS09 • TS10 • TS15 • TS20

Part N°	€
383-001	35,05

Serie **Profesional ESD** • Professional ESD Series • Série **Professionnelle ESD**



Hexágono Conductor
Hex Bolster
Prise 6 Pans



Mango de Disipación Electroestática
Electrostatic Discharging Handle
Manche Décharge Electrostatique

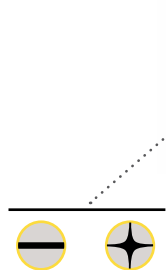

Varilla Circular
Round Blade
Lame Cylindrique

CrMo 56HRC

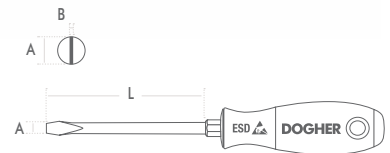

387

Boca Plana • Stamped • Mécanicien



CrMo



A mm	B mm	L mm		Part N°	€
5	1	100	10	387-050-100	9,90
5	1	125	10	387-050-125	10,35
6	1,2	150	10	387-060-150	12,82
6	1,2	200	10	387-060-200	13,18
8	1,2	150	10	387-080-150	16,69
8	1,2	200	10	387-080-200	16,69

388

Boca Phillips • Phillips • Phillips



CrMo



	L mm		Part N°	€
PH0	75	10	388-PH0-075	6,97
PH1	100	10	388-PH1-100	9,25
PH2	125	10	388-PH2-125	10,75
PH3	150	10	388-PH3-150	16,17

Precisión Serie Profesional ESD • Precision Professional ESD Series • Série Professionnelle ESD de Précision



Varilla Circular
Round Blade
Lame Cylindrique

CrMo 56HRC



Mango de Disipación Electroestática
Electrostatic Discharging Handle
Manche Décharge Électrostatique

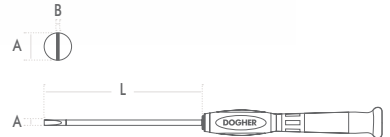

390

Boca Recta • Milled • Electricien



CrMo



A mm	B mm	L mm		Part N°	€
1	0,25	50	10	390-010-050	5,48
1,2	0,25	50	10	390-012-050	5,48
1,5	0,25	50	10	390-015-050	5,48
1,8	0,4	50	10	390-018-050	5,48
2	0,4	50	10	390-020-050	5,48
2,4	0,4	50	10	390-024-050	5,48
3	0,6	50	10	390-030-050	5,48
3,5	0,7	50	10	390-035-050	5,48

391

Boca Phillips • Phillips • Phillips



CrMo



	L mm		Part N°	€
PH000	50	10	391-PH000-050	5,63
PH00	50	10	391-PH00-050	5,48
PH0	50	10	391-PH0-050	5,48

Destornilladores • Screwdrivers • Tournevis

Precisión Serie Profesional ESD • Precision Professional ESD Series • Série Professionnelle ESD de Précision

392

Boca Pozidriv • Pozidriv • Pozidriv



	L mm		Part N°	€
PZO	50	10	392-PZO-050	5,48

393

Boca Torx Seguridad • Torx Tamper • Torx Sécurité



	L mm		Part N°	€
TS5	50	10	393-TS05	5,48
TS6	50	10	393-TS06	5,48

394

Boca Hexagonal • Hexagonal • Hexagonal



	L mm		Part N°	€
HR0,7	50	10	394-HR007	5,48
HR0,9	50	10	394-HR009	5,48
HR1,3	50	10	394-HR013	5,48
HR1,5	50	10	394-HR015	5,48
HR2	50	10	394-HR020	5,48

Juegos - Precisión Serie Profesional ESD • Precision Professional ESD Series Sets • Jeux Série Professionnelle ESD de Précision

390

Estuche de Plástico
Plastic Box • Coffret Plastique

6

Pcs



2 • 2,4 • 3

PH000 • PH00 • PH0



Part N°	€
390-001	35,25

390

Estuche de Plástico
Plastic Box • Coffret Plastique

7

Pcs



1,5 • 2 • 2,4 • 3

PH000 • PH00 • PH0



Part N°	€
390-002	40,73

Destornilladores • Screwdrivers • Tournevis

Destornilladores **Adicionales** • **Additional** Screwdrivers • Tournevis **Complémentaires**

398

Destornillador de Golpe
Impact Screwdriver • Tournevis à Frappe

16
Pcs



5/16" • Puntas de Atornillar • Screwdriver Bits • Embouts de Vissage



HX4 • HX5 • HX6 • HX8



T25 • T30 • T40



PH2 • PH3 • PH4



8 • 10 • 12

Portapuntas Cuadrado de Arrastre
Square Drive Bit Holder
Douille Porte-embouts à Carré d'entraînement

Adaptador Triple Función
3-Way Adapter
Adaptateur avec Triple Fonction

5/16" ▶ ◀ 1/2"

• 3/8" ◀ 5/16"

Destornillador de Golpe
Impact Screwdriver • Tournevis à Frappe

1/2"

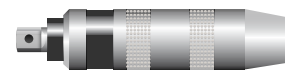

Part N°	€
398-001	49,95

396

Tester • Testeur



A mm	B mm	L mm		Part N°	€
3	0,5	65	10	396-001	5,38

396

Magnetizador - Desmagnetizador
Magnetizer - Demagnetizer • Magnétiseur - Démagnétiseur



Part N°	€
396-002	9,25

Puntas de Atornillar
Screwdriver Bits
Embouts de Vissage



25 mm	1/4"		130	
50 mm	1/4"		132	
25 mm	1/4"		134	
30 mm	5/16"		135	
30 mm	10 mm		136	
75 mm	115 mm	10 mm		137
				138
				139

Puntas de Atornillar • Screwdriver Bits • Embouts de Vissage

1/4" • 25 mm



25 mm

1/4"

S2

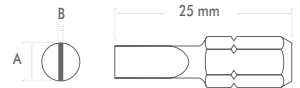

400

Punta Phillips • Phillips • Phillips



		Part N°	€
PH0	10	400-PH0-10	1,05
PH1	10	400-PH1-10	0,75
PH2	10	400-PH2-10	0,75
PH3	10	400-PH3-10	0,75
PH4	10	400-PH4-10	1,13

401

Punta Pozidriv • Pozidriv • Pozidriv



		Part N°	€
PZ0	10	401-PZ0-10	1,05
PZ1	10	401-PZ1-10	0,75
PZ2	10	401-PZ2-10	0,75
PZ3	10	401-PZ3-10	0,75
PZ4	10	401-PZ4-10	1,13

402

Punta Recta • Slot • Plat

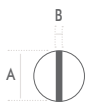

A mm	B mm		Part N°	€
3	0,5	10	402-030-10	1,03
3,5	0,6	10	402-035-10	1,03
4	0,8	10	402-040-10	1,03
4,5	0,8	10	402-045-10	1,03
5	1	10	402-050-10	1,03
5,5	1	10	402-055-10	1,03
6	1,2	10	402-060-10	1,03
6,5	1,2	10	402-065-10	1,03
8	1,2	10	402-080-10	2,50

403

Punta Torx • Torx • Torx



		Part N°	€
T05	10	403-T05-10	1,63
T06	10	403-T06-10	1,63
T07	10	403-T07-10	1,63
T08	10	403-T08-10	1,63
T09	10	403-T09-10	1,63
T10	10	403-T10-10	1,15
T15	10	403-T15-10	1,15
T20	10	403-T20-10	1,15
T25	10	403-T25-10	1,15
T27	10	403-T27-10	1,15
T30	10	403-T30-10	1,15
T40	10	403-T40-10	1,15

1/4" • 25 mm

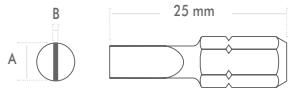

25 mm 1/4" S2

404

Punta Torx Seguridad
Torx Tamper • Torx Sécurité



		Part N°	€
TS10	10	404-TS10-10	1,60
TS15	10	404-TS15-10	1,60
TS20	10	404-TS20-10	1,60
TS25	10	404-TS25-10	1,60
TS27	10	404-TS27-10	1,60
TS30	10	404-TS30-10	1,60
TS40	10	404-TS40-10	1,60

405

Punta Hexagonal • Hexagonal • Hexagonal



		Part N°	€
HX1,5	10	405-HX015-10	1,00
HX2	10	405-HX020-10	1,00
HX2,5	10	405-HX025-10	1,00
HX3	10	405-HX030-10	1,00
HX4	10	405-HX040-10	1,00
HX5	10	405-HX050-10	1,00
HX6	10	405-HX060-10	1,00
HX8	10	405-HX080-10	1,40
HX10	10	405-HX100-10	1,78

406

Punta Robertson • Robertson • Robertson



		Part N°	€
R1	10	406-R1-10	1,13
R2	10	406-R2-10	1,13
R3	10	406-R3-10	1,13

Puntas de Atornillar • Screwdriver Bits • Embouts de Vissage

1/4" • 50 mm



50 mm

1/4"

S2



410

Punta Phillips • Phillips • Phillips



		Part N°	€
PH1	10	410-PH1-10	1,53
PH2	10	410-PH2-10	1,53
PH3	10	410-PH3-10	1,53
PH4	10	410-PH4-10	1,53

411

Punta Pozidriv • Pozidriv • Pozidriv



		Part N°	€
PZ1	10	411-PZ1-10	1,53
PZ2	10	411-PZ2-10	1,53
PZ3	10	411-PZ3-10	1,53
PZ4	10	411-PZ4-10	1,53

412

Punta Recta • Slot • Plat

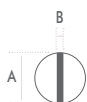

A mm	B mm		Part N°	€
3	0,5	10	412-030-10	2,08
3,5	0,6	10	412-035-10	2,08
4	0,8	10	412-040-10	2,08
4,5	0,8	10	412-045-10	2,08
5	1	10	412-050-10	2,08
5,5	1	10	412-055-10	2,08
6	1,2	10	412-060-10	2,08
6,5	1,2	10	412-065-10	2,08
8	1,2	10	412-080-10	3,50

413

Punta Torx • Torx • Torx



		Part N°	€
T05	10	413-T05-10	3,28
T06	10	413-T06-10	3,28
T07	10	413-T07-10	3,28
T08	10	413-T08-10	3,28
T09	10	413-T09-10	3,28
T10	10	413-T10-10	3,13
T15	10	413-T15-10	3,13
T20	10	413-T20-10	3,13
T25	10	413-T25-10	3,13
T27	10	413-T27-10	3,13
T30	10	413-T30-10	3,13
T40	10	413-T40-10	3,13

1/4" • 50 mm



414

Punta Hexagonal • Hexagonal • Hexagonal



Icon	Quantity	Part N°	€
	10	414-HX020-10	2,03
	10	414-HX025-10	2,03
	10	414-HX030-10	2,03
	10	414-HX040-10	2,03
	10	414-HX050-10	2,03
	10	414-HX060-10	2,03
	10	414-HX080-10	3,00

415

Punta Robertson • Robertson • Robertson



Icon	Quantity	Part N°	€
	10	415-R1-10	3,00
	10	415-R2-10	3,00
	10	415-R3-10	3,00

Puntas de Atornillar • Screwdriver Bits • Embouts de Vissage

1/4" • 25 mm TiN



25 mm 1/4" S2



TiN

420

Punta Phillips • Phillips • Phillips



		Part N°	€
PH1	5	420-PH1-5	2,15
PH2	5	420-PH2-5	2,15
PH3	5	420-PH3-5	2,15

TiN

421

Punta Pozidriv • Pozidriv • Pozidriv



		Part N°	€
PZ1	5	421-PZ1-5	2,15
PZ2	5	421-PZ2-5	2,15
PZ3	5	421-PZ3-5	2,15

TiN

422

Punta Recta • Slot • Plat



A mm	B mm		Part N°	€
4,5	0,8	5	422-045-5	2,08
5,5	1	5	422-055-5	2,08
6,5	1,2	5	422-065-5	2,08

TiN

423

Punta Torx • Torx • Torx



		Part N°	€
T10	5	423-T10-5	2,23
T15	5	423-T15-5	2,23
T20	5	423-T20-5	2,23
T25	5	423-T25-5	2,23
T27	5	423-T27-5	2,23
T30	5	423-T30-5	2,23
T40	5	423-T40-5	2,23

5/16" • 30 mm

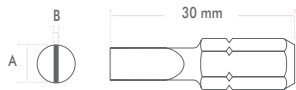

30 mm 5/16" S2



430

Punta Phillips • Phillips • Phillips



		Part N°	€
PH1	10	430-PH1-10	2,03
PH2	10	430-PH2-10	2,03
PH3	10	430-PH3-10	2,03
PH4	10	430-PH4-10	2,03

431

Punta Pozidriv • Pozidriv • Pozidriv



		Part N°	€
PZ1	10	431-PZ1-10	2,03
PZ2	10	431-PZ2-10	2,03
PZ3	10	431-PZ3-10	2,03
PZ4	10	431-PZ4-10	2,03

432

Punta Recta • Slot • Plat Large

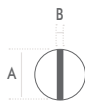

A mm	B mm		Part N°	€
8	1,2	10	432-080-10	2,14
10	1,6	10	432-100-10	2,76
12	1,8	10	432-120-10	3,86
14	1,8	10	432-140-10	6,65

433

Punta Torx • Torx • Torx



		Part N°	€
T40	10	433-T40-10	2,29
T45	10	433-T45-10	2,29
T50	10	433-T50-10	2,29
T55	10	433-T55-10	3,35
T60	10	433-T60-10	6,08

434

Punta Torx Seguridad
Torx Tamper • Torx Sécurité



		Part N°	€
TS45	10	434-TS45-10	4,10
TS50	10	434-TS50-10	4,10
TS55	10	434-TS55-10	4,47

435

Punta Hexagonal • Hexagonal • Hexagonal



		Part N°	€
HX10	10	435-HX10-10	2,62
HX12	10	435-HX12-10	3,67
HX14	10	435-HX14-10	5,37

Puntas de Atornillar • Screwdriver Bits • Embouts de Vissage

10 mm • 30 mm



30 mm 10 mm S2

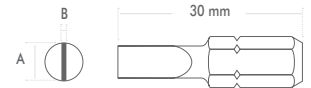

437

Punta Hexagonal • Hexagonal • Hexagonal



30 mm



		Part N°	€
HX4	5	437-HX4	2,30
HX5	5	437-HX5	2,30
HX6	5	437-HX6	2,30
HX7	5	437-HX7	2,30
HX8	5	437-HX8	2,30
HX10	5	437-HX10	1,68
HX12	5	437-HX12	2,46

437

Punta Ribe • Ribe • Ribe



30 mm



		Part N°	€
RIBE6	5	437-RIBE6	2,69
RIBE7	5	437-RIBE7	2,69
RIBE8	5	437-RIBE8	2,69
RIBE9	5	437-RIBE9	2,69
RIBE10	5	437-RIBE10	2,69
RIBE12	5	437-RIBE12	3,59
RIBE14	5	437-RIBE14	4,10

437

Punta XZN • XZN • XZN



30 mm



		Part N°	€
XZN5	5	437-XZN5	2,69
XZN6	5	437-XZN6	2,69
XZN8	5	437-XZN8	2,69
XZN10	5	437-XZN10	2,69
XZN12	5	437-XZN12	3,59
XZN14	5	437-XZN14	4,10

437

Punta Torx • Torx • Torx



30 mm



		Part N°	€
T20	5	437-T20	2,69
T25	5	437-T25	2,69
T30	5	437-T30	2,69
T40	5	437-T40	2,69
T45	5	437-T45	2,69
T50	5	437-T50	2,69
T55	5	437-T55	2,69

437

Punta Robertson • Robertson • Robertson



30 mm



		Part N°	€
R8	5	437-R8	2,56
R10	5	437-R10	2,75

10 mm • 75 mm

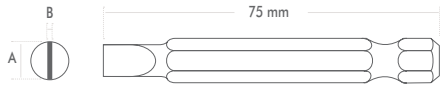

75 mm 10 mm S2



437

Punta Hexagonal • Hexagonal • Hexagonal



75 mm



Icon	Icon	Part N°	€
		HX4	5 437-HX4-75 3,53
		HX5	5 437-HX5-75 3,53
		HX6	5 437-HX6-75 3,53
		HX7	5 437-HX7-75 3,53
		HX8	5 437-HX8-75 3,53
		HX10	5 437-HX10-75 3,07
		HX12	5 437-HX12-75 3,69

10 mm • 115 mm

HX10	5	437-HX10-115	3,55
-------------	---	--------------	------

437

Punta Ribe • Ribe • Ribe



75 mm



Icon	Icon	Part N°	€
		RIBE6	5 437-RIBE6-75 3,90
		RIBE7	5 437-RIBE7-75 3,90
		RIBE8	5 437-RIBE8-75 3,90
		RIBE9	5 437-RIBE9-75 4,34
		RIBE10	5 437-RIBE10-75 4,34
		RIBE12	5 437-RIBE12-75 5,29
		RIBE14	5 437-RIBE14-75 7,06

437

Punta XZN • XZN • XZN



75 mm



Icon	Icon	Part N°	€
		XZN5	5 437-XZN5-75 2,88
		XZN6	5 437-XZN6-75 2,88
		XZN8	5 437-XZN8-75 2,88
		XZN10	5 437-XZN10-75 3,68
		XZN12	5 437-XZN12-75 4,55

437

Punta Torx • Torx • Torx



75 mm



Icon	Icon	Part N°	€
		T20	5 437-T20-75 3,67
		T25	5 437-T25-75 3,67
		T30	5 437-T30-75 3,67
		T40	5 437-T40-75 3,68
		T45	5 437-T45-75 3,68
		T50	5 437-T50-75 3,68
		T55	5 437-T55-75 5,15

10 mm • 115 mm

T55	5	437-T55-115	5,56
------------	---	-------------	------

Vasos Hexagonales y Portapuntas • Nut Driver & Bit Holders • Douilles Hexagonales et Porte-Embouts

440

Vaso Hexagonal Magnético
Magnetic Nut Driver • Douille Hexagonale Magnétique



⊙	📦	Part N°	€
6	2	440-060	4,80
7	2	440-070	4,80
8	2	440-080	4,90
10	2	440-100	5,15
11	2	440-110	5,25
12	2	440-120	5,38
13	2	440-130	5,60

441

Vaso Hexagonal Magnético Largo
Long Magnetic Nut Driver
Douille Hexagonale Magnétique Longue



⊙	📦	Part N°	€
6	2	441-060	4,80
7	2	441-070	4,80
8	2	441-080	4,90
10	2	441-100	5,15
11	2	441-110	5,25
12	2	441-120	5,38
13	2	441-130	5,60

443

Portapuntas Magnético con Anillo
Magnetic Bit Holder with Ring
Porte-Embouts Magnétique avec Anneau



L mm	📦	Part N°	€
50	1	443-050	5,38
58	1	443-058	5,63
74	1	443-074	8,50
100	1	443-100	9,75
200	1	443-200	10,75

445

Portapuntas Magnético SDS Plus con Anillo
SDS Plus Magnetic Bit Holder with Ring
Porte-Embouts Magnétique SDS Plus avec Anneau



L mm	📦	Part N°	€
78	1	445-001	13,75



Juegos de Puntas de Atornillar • Screwdriver Bit Sets • Jeux d'Embouts de Vissage

438

Juego de Puntas y Portapuntas • Screwdriver Bit Set and Bit Holder • Jeux d'Embouts de Vissage avec Porte-Embouts

32

Pcs

1/4"

25 mm



★ T06 · T07 · T08 · T09 · T10 · T15
T20 · T25 · T27 · T30 · T40

★ PZ0 · PZ1 · PZ2 · PZ3

◆ HX3 · HX4 · HX5 · HX6

— 3 · 4 · 5 · 6 · 6,5

★ PH0 · PH1 · PH2 (3Pcs) · PH3

Adaptador
Adapter • Adaptateur

Portapuntas Magnético con Anillo • 60 mm
Magnetic Bit Holder with Ring • 60 mm
Porte-Embouts Magnétique avec Anneau • 60 mm

1/4" ◀ ▶ 1/4"

1/4" 1/4"

Part N°	€
438-001	35,06

438

Juego de Puntas y Llave de Carraca • Screwdriver Bit Set and Ratchet Handle • Jeux d'Embouts de Vissage avec Clé à Cliquet

32

Pcs

1/4"

25 mm



★ T06 · T07 · T08 · T09 · T10 · T15
T20 · T25 · T30 · T40

★ PZ0 · PZ1 · PZ2 · PZ3

◆ HX3 · HX4 · HX5 · HX6

— 3 · 4 · 5 · 6 · 6,5

★ PH0 · PH1 · PH2 · PH3

■ R0 · R1 · R2 · R3

Llave de Carraca
Ratchet Handle • Clé à Cliquet



Part N°	€
438-002	37,28

438

Juego de Puntas y Llave de Carraca • Screwdriver Bit Set and Ratchet Handle • Jeux d'Embouts de Vissage avec Clé à Cliquet

11

Pcs

1/4"

25 mm



★ PH1 · PH2 · PH3

★ PZ1 · PZ2 · PZ3

— 3 · 4 · 5 · 6

Llave de Carraca
Ratchet Handle • Clé à Cliquet



Part N°	€
438-003	33,17

10 mm

Juegos de Puntas de Atornillar • Screwdriver Bits Sets • Jeux d'Embouts de Vissage

438

Juego de Puntas y Portapuntas • Screwdriver Bit Set and Bit Coupler • Jeux d'Embouts de Vissage avec Porte-Embouts

15
Pcs

10
mm

S2



Portapuntas
Bit Coupler • Porte-embouts 10 mm ▶  ◀ 1/2" (543-027)

 10 mm x 30 mm HX4 · HX5 · HX6 · HX7 · HX8 · HX10 · HX12

 10 mm x 75 mm HX4 · HX5 · HX6 · HX7 · HX8 · HX10 · HX12

Part N°	€
438-004	45,33

438

Juego de Puntas y Portapuntas • Screwdriver Bit Set and Bit Coupler • Jeux d'Embouts de Vissage avec Porte-Embouts

15
Pcs

10
mm

S2



Portapuntas
Bit Coupler • Porte-embouts 10 mm ▶  ◀ 1/2" (543-027)

 10 mm x 30 mm RIB6 · RIB7 · RIB8 · RIB9
RIB10 · RIB12 · RIB14

 10 mm x 75 mm RIB6 · RIB7 · RIB8 · RIB9
RIB10 · RIB12 · RIB14

Part N°	€
438-005	61,87

438

Juego de Puntas y Portapuntas • Screwdriver Bit Set and Bit Coupler • Jeux d'Embouts de Vissage avec Porte-Embouts

11
Pcs

10
mm

S2



Portapuntas
Bit Coupler • Porte-embouts 10 mm ▶  ◀ 1/2" (543-027)

 10 mm x 30 mm XZN5 · XZN6 · XZN8 · XZN10 · XZN12

 10 mm x 75 mm XZN5 · XZN6 · XZN8 · XZN10 · XZN12

Part N°	€
438-006	40,89

438

Juego de Puntas y Portapuntas • Screwdriver Bit Set and Bit Coupler • Jeux d'Embouts de Vissage avec Porte-Embouts

15
Pcs

10
mm

S2

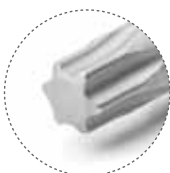

Portapuntas
Bit Coupler • Porte-embouts 10 mm ▶  ◀ 1/2" (543-027)

 10 mm x 30 mm T20 · T25 · T30 · T40 · T45 · T50 · T55

 10 mm x 75 mm T20 · T25 · T30 · T40 · T45 · T50 · T55

Part N°	€
438-007	44,27

Llaves
Wrenches
Clés



		142
		145
		149
		155
		157
		161
		162
		166
		168
		170
		174
		177
		178
		180
		181
		182

Llaves Ajustables • Adjustable Wrenches • Clés à Molette

Moleta Central y Lateral • European and Spanish Type • Molette Centrale et Latérale
491 Llave Ajustable Moleta Lateral
 Spanish Type Adjustable Wrench • Clé à Molette Latérale

CrV



L mm	L "	⌀ mm	Part N°	€
150	6	24	491-150	27,13
200	8	29	491-200	30,13
250	10	33	491-250	37,38
300	12	38	491-300	48,25
400	16	50	491-400	80,63
500	20	62	491-500	133,33

492 Llave Ajustable Gran Apertura
 Extra Wide Adjustable Wrench • Clé à Molette Ouverture Extra

CrV



L mm	L "	⌀ mm	Part N°	€
150	6	34	492-150	26,35
200	8	38	492-200	28,58
250	10	50	492-250	35,03

493 Llave Ajustable Profesional
 Professional Adjustable Wrench • Clé à Molette Professionnelle

CrV



L mm	L "	⌀ mm	Part N°	€
150	6	24	493-150	17,68
200	8	29	493-200	20,30
250	10	33	493-250	25,03
300	12	38	493-300	33,73
380	15	50	493-380	57,38
450	18	60	493-450	89,28
600	24	70	493-600	219,78

Llaves Ajustables • Adjustable Wrenches • Clés à Molette

497

Llave Ajustable Aislada Moleta Lateral

Insulated Spanish Type Adjustable Wrench • Clé à Molette Latérale Isolée

CrV

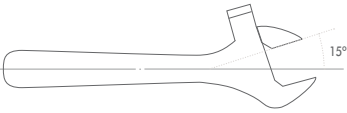

TESTED



L mm	L "	mm	Part N°	€
200	8	28	497-200	166,41
250	10	33	497-250	186,07
300	12	38	497-300	202,71

496

Llave Ajustable de Carraca Moleta Central

Ratcheting Adjustable Wrench • Clé à Molette à Cliquet

CrV

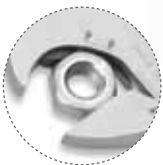
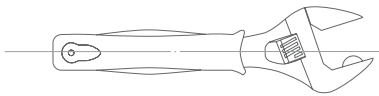

L mm	L "	mm	Part N°	€
150	6	6~20	496-150	26,52
200	8	6~24	496-200	30,45
250	10	6~30	496-250	45,22

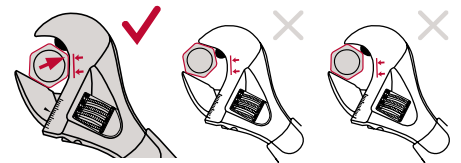

• Posicione la llave como se muestra en la imagen.
Put the wrench like in picture.
Placer la clé comme indiqué dans l'image ci-dessus.

495

Llave Ajustable Aislada Moleta Central

Insulated Adjustable Wrench • Clé à Molette Isolée

CrV

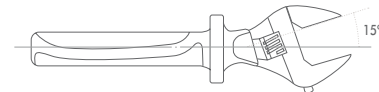

TESTED



L mm	L "	mm	Part N°	€
200	8	25	495-200	41,16
250	10	33	495-250	48,20

Mango Bimaterial
Bimaterial Handle
Manche Bi-matière

Llaves Ajustables • Adjustable Wrenches • Clés à Molette

Juegos Llaves Ajustables • Adjustable Wrench Sets • Jeux de Clés à Molette

491

Bandeja Combinable

EVA Foam Tray • Panneau de Mousse Modulable

3

Pcs

CrV



1/4 (375 x 140 x 30 mm)



150mm • 200mm • 250mm

Part N°	€
491-080	101,00

493

Bandeja Combinable

EVA Foam Tray • Panneau de Mousse Modulable

3

Pcs

CrV



1/4 (375 x 140 x 30 mm)



150mm • 200mm • 250mm

Part N°	€
493-080	69,38

Ver Información Ampliada sobre Almacenaje y Bandejas Combinables en Páginas:

Further Information about Storage and EVA Foam Trays in Pages:

Voir pour Plus d'information sur le Rangement et Panneaux de Mousse Modulables Pages:

10 • 11

Llaves **Doble Boca Abierta** • Double Open Ended Wrenches • Clés à Fourches

450

Doble Boca Abierta

Double Open Ended Wrench • Clé à Fourches

CrV

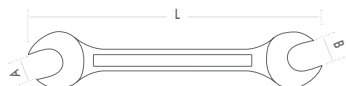

A mm	B mm	L mm	Part N°	€
6	7	123	450-06-07	4,28
7	8	129	450-07-08	4,48
8	9	140	450-08-09	4,40
8	10	141	450-08-10	4,80
10	11	155	450-10-11	4,80
10	12	156	450-10-12	5,75
10	13	170	450-10-13	5,88
11	13	172	450-11-13	5,88
12	13	172	450-12-13	5,75
12	14	179	450-12-14	6,00
13	15	189	450-13-15	6,25
13	17	205	450-13-17	7,16
14	15	190	450-14-15	6,15
16	17	204	450-16-17	7,14
16	18	210	450-16-18	7,45
17	19	221	450-17-19	8,31
18	19	220	450-18-19	8,36
19	22	237	450-19-22	9,96
20	22	237	450-20-22	9,86
21	23	247	450-21-23	10,66
22	24	247	450-22-24	10,82
24	26	263	450-24-26	12,53
24	27	266	450-24-27	12,67
25	28	280	450-25-28	14,40
27	29	280	450-27-29	16,98
27	30	285	450-27-30	18,25
27	32	300	450-27-32	18,50
30	32	298	450-30-32	19,29
32	36	350	450-32-36	33,99
34	36	380	450-34-36	36,88
36	41	380	450-36-41	40,04
41	46	415	450-41-46	57,11
46	50	465	450-46-50	73,45

SAE

A "	B "	L mm	Part N°	€
1/4"	5/16"	123	450-1/4-5/16	4,34
5/16"	3/8"	140	450-5/16-3/8	4,50
3/8"	7/16"	156	450-3/8-7/16	5,25
7/16"	1/2"	172	450-7/16-1/2	6,25
1/2"	9/16"	172	450-1/2-9/16	6,25
9/16"	5/8"	188	450-9/16-5/8	7,00
5/8"	11/16"	204	450-5/8-11/16	7,72
11/16"	3/4"	220	450-11/16-3/4	9,25
13/16"	7/8"	238	450-13/16-7/8	11,00
15/16"	1"	266	450-15/16-1	14,75
1"	1.1/8"	280	450-1-1.1/8	16,38
1.1/16"	1.1/4"	298	450-1.1/16-1.1/4	20,75



• Consulte envase unitario con colgador
Hanging unit packaging available
Nous consulter pour présentation brochable

Juegos de Llaves Doble Boca Abierta • Double Open Ended Wrench Sets • Jeux de Clés à Fourches

450

Bolsa de Nylon
Nylon Pouch • Trousse Tissu

8

Pcs

CrV



390 x 300 mm



• 6x7 • 8x9 • 10x11 • 12x13 • 14x15 • 16x17
• 18x19 • 20x22

Part N°	€
450-001	53,52
450-001V *	11,07

* Bolsa de Nylon Vacía
Empty Nylon Pouch • Trousse Tissu Vide

450

Bolsa de Nylon
Nylon Pouch • Trousse Tissu

12

Pcs

CrV



620 x 350 mm



• 6x7 • 8x9 • 10x11 • 12x13 • 14x15 • 16x17
• 18x19 • 20x22 • 21x23 • 24x27 • 25X28 • 30X32

Part N°	€
450-002	110,93
450-002V *	12,67

* Bolsa de Nylon Vacía
Empty Nylon Pouch • Trousse Tissu Vide

450

Bolsa de Nylon
Nylon Pouch • Trousse Tissu

7

Pcs

CrV

SAE



300 x 390 mm



• 1/4" x 5/16" • 5/16" x 3/8" • 3/8" x 7/16"
• 1/2" x 9/16" • 9/16" x 5/8" • 5/8" x 11/16"
• 11/16" x 3/4"

Part N°	€
450-003	47,09
450-003V *	11,07

* Bolsa de Nylon Vacía
Empty Nylon Pouch • Trousse Tissu Vide

450

Bolsa de Nylon
Nylon Pouch • Trousse Tissu

11

Pcs

CrV

SAE



620 x 350 mm



• 1/4" x 5/16" • 5/16" x 3/8" • 3/8" x 7/16"
• 1/2" x 9/16" • 9/16" x 5/8" • 5/8" x 11/16"
• 11/16" x 3/4" • 13/16" x 7/8" • 15/16" x 1"
• 1" x 1.1/8" • 1.1/16" x 1.1/4"

Part N°	€
450-004	110,37
450-004V *	12,67

* Bolsa de Nylon Vacía
Empty Nylon Pouch • Trousse Tissu Vide

Juegos de Llaves Doble Boca Abierta • Double Open Ended Wrench Sets • Jeux de Clés à Fourches

450

Soporte de Plástico
Plastic Holder • Présentoir Plastique

6

Pcs

CrV



• 6x7 • 8x9 • 10x11 • 12x13 • 14x15 • 16x17

Part N°	€
450-016	34,33
450-011V *	8,10

* Soporte de Plástico Vacío
Empty Plastic Holder • Présentoir Plastique Vide

450

Soporte de Plástico
Plastic Holder • Présentoir Plastique

8

Pcs

CrV



• 6x7 • 8x9 • 10x11 • 12x13 • 14x15 • 16x17
• 18x19 • 20x22

Part N°	€
450-018	52,84
450-013V *	9,45

* Soporte de Plástico Vacío
Empty Plastic Holder • Présentoir Plastique Vide

450

Soporte de Plástico
Plastic Holder • Présentoir Plastique

10

Pcs

CrV



• 6x7 • 8x9 • 10x11 • 12x13 • 14x15 • 16x17
• 18x19 • 20x22 • 21x23 • 24x27

Part N°	€
450-020	76,78
450-015V *	12,15

* Soporte de Plástico Vacío
Empty Plastic Holder • Présentoir Plastique Vide

450

Soporte de Plástico
Plastic Holder • Présentoir Plastique

12

Pcs

CrV



• 6x7 • 8x9 • 10x11 • 12x13 • 14x15 • 16x17
• 18x19 • 20x22 • 21x23 • 24x27 • 25x28 • 27x29

Part N°	€
450-022	108,30
450-017V *	12,83

* Soporte de Plástico Vacío
Empty Plastic Holder • Présentoir Plastique Vide

Juegos de Llaves Doble Boca Abierta • Double Open Ended Wrench Sets • Jeux de Clés à Fourches

450

Caja de Cartón
Carton Box • Étui Carton

5

Pcs

CrV



• 6x7 • 8x9 • 10x11 • 12x13 • 14x15

Part N°	€
450-035	27,21

450

Caja de Cartón
Carton Box • Étui Carton

6

Pcs

CrV



• 6x7 • 8x9 • 10x11 • 12x13 • 14x15 • 16x17

Part N°	€
450-036	34,63

450

Caja de Cartón
Carton Box • Étui Carton

8

Pcs

CrV



• 6x7 • 8x9 • 10x11 • 12x13 • 14x15 • 16x17
• 18x19 • 20x22

Part N°	€
450-038	53,27

450

Bandeja Combinable
EVA Foam Tray • Panneau de Mousse Modulable

8

Pcs

CrV



1/4 (375 x 140 x 30 mm)

• 6x7 • 8x9 • 10x11 • 12x13 • 14x15
• 16x17 • 18x19 • 20x22

Part N°	€
450-080	57,12

450

Bandeja Combinable
EVA Foam Tray • Panneau de Mousse Modulable

10

Pcs

CrV



1/3 (375 x 188 x 30 mm)

• 6x7 • 8x9 • 10x11 • 12x13 • 14x15
• 16x17 • 18x19 • 20x22 • 21x23 • 24x26

Part N°	€
450-081	83,06

451

Combinada
Combination Wrench • Clé Mixte

CrV

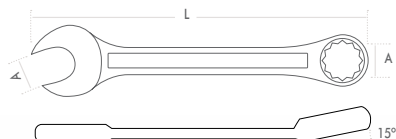

A mm	L mm	Part N°	€
6	100	451-06	5,66
7	110	451-07	5,70
8	120	451-08	5,81
9	130	451-09	6,91
10	140	451-10	6,97
11	150	451-11	7,63
12	160	451-12	8,04
13	170	451-13	8,56
14	180	451-14	8,77
15	190	451-15	9,04
16	200	451-16	9,71
17	210	451-17	10,33
18	220	451-18	10,96
19	230	451-19	12,38
20	240	451-20	12,61
21	250	451-21	14,26
22	260	451-22	14,62
23	270	451-23	15,44
24	280	451-24	16,20
25	290	451-25	17,47
26	300	451-26	20,86
27	310	451-27	22,84
28	320	451-28	24,34
29	330	451-29	24,71
30	340	451-30	26,43
32	360	451-32	29,00
33	380	451-33	45,66
34	380	451-34	41,54
35	410	451-35	58,99

A mm	L mm	Part N°	€
36	410	451-36	52,11
38	430	451-38	71,11
41	460	451-41	75,78
43	460	451-43	113,99
46	500	451-46	103,24
48	540	451-48	143,87
50	540	451-50	130,12
55	560	451-55	234,88
58	600	451-58	333,33
60	600	451-60	333,33
65	680	451-65	388,77
70	680	451-70	415,89
75	730	451-75	588,77
80	730	451-80	634,99
85	790	451-85	912,99
90	790	451-90	945,33
95	790	451-95	999,77
100	860	451-100	1.066,00
105	860	451-105	1.100,55

SAE

A "	L mm	Part N°	€
1/4"	100	451-1/4	5,72
5/16"	120	451-5/16	5,91
3/8"	140	451-3/8	6,97
7/16"	150	451-7/16	7,70
1/2"	170	451-1/2	8,66
9/16"	180	451-9/16	8,84
5/8"	200	451-5/8	9,81
11/16"	210	451-11/16	10,66
3/4"	230	451-3/4	12,51
13/16"	250	451-13/16	14,46
7/8"	260	451-7/8	14,75
15/16"	280	451-15/16	16,13
1"	290	451-1	17,60
1.1/16"	310	451-1.1/16	23,11
1.1/8"	330	451-1.1/8	24,54
1.1/4"	360	451-1.1/4	29,26

Juegos de Llaves Combinadas • Combination Wrench Sets • Jeux de Clés Mixtes

451

Bolsa de Nylon
Nylon Pouch • Trousse Tissu

14

Pcs

CrV



470 x 390 mm



Part N°	€
451-001	143,65
451-001V *	11,37

* Bolsa de Nylon Vacía
Empty Nylon Pouch • Trousse Tissu Vide

451

Bolsa de Nylon
Nylon Pouch • Trousse Tissu

14

Pcs

CrV



650 x 440 mm



Part N°	€
451-002	187,82
451-002V *	13,27

* Bolsa de Nylon Vacía
Empty Nylon Pouch • Trousse Tissu Vide

451

Bolsa de Nylon
Nylon Pouch • Trousse Tissu

17

Pcs

CrV



470 x 450 mm

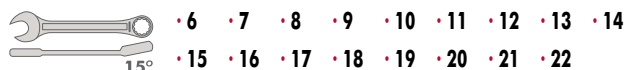

Part N°	€
451-003	160,82
451-003V *	11,37

* Bolsa de Nylon Vacía
Empty Nylon Pouch • Trousse Tissu Vide

451

Bolsa de Nylon
Nylon Pouch • Trousse Tissu

18

Pcs

CrV



650 x 480 mm

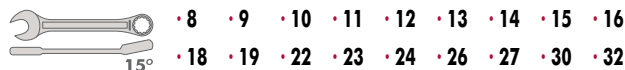

Part N°	€
451-004	243,37
451-004V *	12,77

* Bolsa de Nylon Vacía
Empty Nylon Pouch • Trousse Tissu Vide

Juegos de Llaves Combinadas • Combination Wrench Sets • Jeux de Clés Mixtes

451

Bolsa de Nylon
Nylon Pouch • Trousse Tissu

24
Pcs

CrV

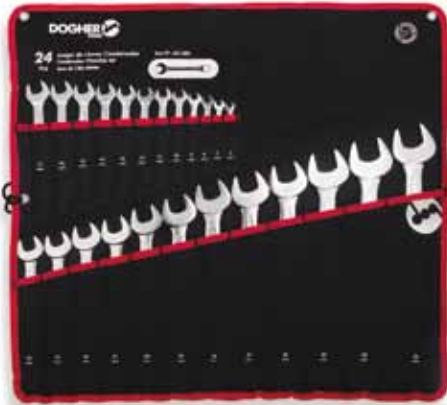

650 x 580 mm

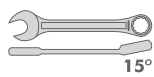

• 6 • 7 • 8 • 9 • 10 • 11 • 12 • 13 • 14
• 15 • 16 • 17 • 18 • 19 • 20 • 21 • 22 • 24
• 26 • 27 • 28 • 30 • 32 • 36

Part N°	€
451-005	351,49
451-005V *	15,46

* Bolsa de Nylon Vacía
Empty Nylon Pouch • Trousse Tissu Vide

451

Bolsa de Nylon
Nylon Pouch • Trousse Tissu

26
Pcs

CrV



650 x 500 mm

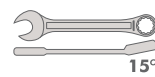

• 6 • 7 • 8 • 9 • 10 • 11 • 12 • 13 • 14
• 15 • 16 • 17 • 18 • 19 • 20 • 21 • 22 • 23
• 24 • 25 • 26 • 27 • 28 • 29 • 30 • 32

Part N°	€
451-006	359,14
451-006V *	15,46

* Bolsa de Nylon Vacía
Empty Nylon Pouch • Trousse Tissu Vide

451

Bolsa de Nylon
Nylon Pouch • Trousse Tissu

8
Pcs

SAE

CrV



330 x 300 mm

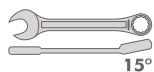

• 1/4" • 5/16" • 3/8" • 7/16" • 1/2" • 9/16"
• 5/8" • 11/16"

Part N°	€
451-007	66,87
451-007V *	10,37

* Bolsa de Nylon Vacía
Empty Nylon Pouch • Trousse Tissu Vide

451

Bolsa de Nylon
Nylon Pouch • Trousse Tissu

12
Pcs

SAE

CrV



550 x 350 mm

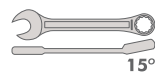

• 3/8" • 7/16" • 1/2" • 9/16" • 5/8" • 11/16"
• 3/4" • 13/16" • 7/8" • 15/16" • 1" • 1.1/16"

Part N°	€
451-008	154,44
451-008V *	12,97

* Bolsa de Nylon Vacía
Empty Nylon Pouch • Trousse Tissu Vide

Juegos de Llaves Combinadas • Combination Wrench Sets • Jeux de Clés Mixtes

451

Bolsa de Nylon
Nylon Pouch • Trousse Tissu

14 SAE

Pcs

CrV



650 x 440 mm

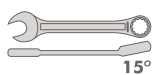

• 3/8" • 7/16" • 1/2" • 9/16" • 5/8"
• 11/16" • 3/4" • 13/16" • 7/8" • 15/16"
• 1" • 1.1/16" • 1.1/8" • 1.1/4"

Part N°	€
451-009	208,32
451-009V *	13,27

* Bolsa de Nylon Vacía
Empty Nylon Pouch • Trousse Tissu Vide

451

Caja de Cartón
Carton Box • Étui Carton

5

Pcs

CrV

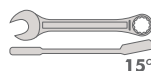

• 8 • 10 • 11 • 12 • 13

Part N°	€
451-035	38,84

451

Caja de Cartón
Carton Box • Étui Carton

6

Pcs

CrV

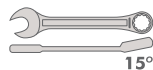

• 8 • 10 • 11 • 12 • 13 • 14

Part N°	€
451-036	47,89

451

Caja de Cartón
Carton Box • Étui Carton

8

Pcs

CrV

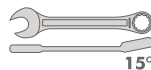

• 8 • 10 • 11 • 12 • 13 • 14 • 17 • 19

Part N°	€
451-038	71,03

Juegos de Llaves Combinadas • Combination Wrench Sets • Jeux de Clés Mixtes

451

Soporte de Plástico
Plastic Holder • Présentoir Plastique

6

Pcs

CrV

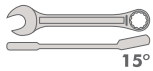

• 8 • 10 • 11 • 12 • 13 • 14

Part N°	€
451-016	47,59
450-011V *	8,10

* Soporte de Plástico Vacío
Empty Plastic Holder • Présentoir Plastique Vide

451

Soporte de Plástico
Plastic Holder • Présentoir Plastique

8

Pcs

CrV

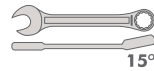

• 8 • 10 • 11 • 12 • 13 • 14 • 17 • 19

Part N°	€
451-018	70,60
450-013V *	9,45

* Soporte de Plástico Vacío
Empty Plastic Holder • Présentoir Plastique Vide

451

Soporte de Plástico
Plastic Holder • Présentoir Plastique

10

Pcs

CrV

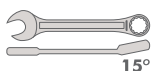

• 8 • 9 • 10 • 11 • 12 • 13 • 14
• 15 • 16 • 17

Part N°	€
451-020	84,49
450-015V *	12,15

* Soporte de Plástico Vacío
Empty Plastic Holder • Présentoir Plastique Vide

451

Soporte de Plástico
Plastic Holder • Présentoir Plastique

12

Pcs

CrV

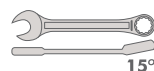

• 8 • 9 • 10 • 11 • 12 • 13 • 14
• 15 • 16 • 17 • 18 • 19

Part N°	€
451-022	107,98
450-017V *	12,83

* Soporte de Plástico Vacío
Empty Plastic Holder • Présentoir Plastique Vide

Juegos de Llaves Combinadas • Combination Wrench Sets • Jeux de Clés Mixtes

451

Bandeja Combinable

EVA Foam Tray • Panneau de Mousse Modulable

8

Pcs

CrV



1/4 (375 x 140 x 30 mm)

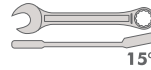

• 8 • 10 • 11 • 12 • 13 • 14 • 17 • 19

Part N°	€
451-080	74,88

451

Bandeja Combinable

EVA Foam Tray • Panneau de Mousse Modulable

10

Pcs

CrV



1/3 (375 x 188 x 30 mm)

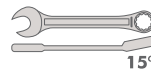

• 8 • 10 • 11 • 12 • 13 • 14 • 17
• 19 • 22 • 24

Part N°	€
451-081	108,44

Ver Información Ampliada sobre Almacenaje y Bandejas Combinables en Páginas:

Further Information about Storage and EVA Foam Trays in Pages:

Voir pour Plus d'information sur le Rangement et Panneaux de Mousse Modulables Pages:

10 • 11

Llaves de **Doble Boca Estrella Planas** • **Double Ring Flat Wrenches** • Clés **Polygonales Planas**

454

Doble Boca Estrella Plana
Double Ring Flat Wrench • Clé Polygonale Plate

CrV



mm	mm	L mm	Part N°	€
6	7	120	454-06-07	7,41
8	9	135	454-08-09	7,67
10	11	150	454-10-11	8,51
12	13	165	454-12-13	9,29
14	15	185	454-14-15	10,20
16	17	210	454-16-17	10,96
17	19	225	454-17-19	11,38
18	19	225	454-18-19	11,38
20	22	240	454-20-22	13,17
21	23	255	454-21-23	14,41
24	26	270	454-24-26	18,17
24	27	270	454-24-27	18,17
25	28	285	454-25-28	18,17
27	29	315	454-27-29	21,92
30	32	335	454-30-32	23,05

Juegos de Llaves de **Doble Boca Estrella Planas** • **Double Ring Flat Wrench Sets** • Jeux de Clés **Polygonales Planas**

454

Bolsa de Nylon
Nylon Pouch • Trousse Tissu

8
Pcs

CrV



390 x 380 mm



• 6x7 • 8x9 • 10x11 • 12x13 • 14x15 • 16x17
• 18x19 • 20x22

Part N°	€
454-001	81,39
454-001V *	11,27

* Bolsa de Nylon Vacía
Empty Nylon Pouch • Trousse Tissu Vide

Juegos de Llaves de **Doble Boca Estrella Planas** • **Double Ring Flat Wrench Sets** • Jeux de Clés **Polygonales Plates**

454

Bolsa de Nylon
Nylon Pouch • Trousse Tissu

10
Pcs

CrV



620 x 480 mm

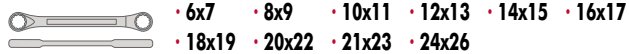

Part N°	€
454-002	114,39
454-002V *	12,55

* Bolsa de Nylon Vacía
Empty Nylon Pouch • Trousse Tissu Vide

454

Bolsa de Nylon
Nylon Pouch • Trousse Tissu

12
Pcs

CrV



620 x 480 mm

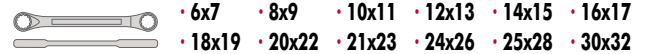

Part N°	€
454-003	155,71
454-003V *	13,07

* Bolsa de Nylon Vacía
Empty Nylon Pouch • Trousse Tissu Vide

Llaves de **Doble Boca Torx Plana** • **Double E Socket Wrenches** • Clés **Torx Plates**

477

Doble Boca Torx Plana
Double E Socket Wrench • Clé Torx Plate

CrV

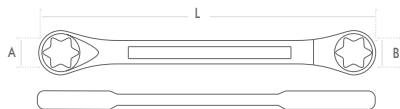

		L mm	Part N°	€
E6	E8	130	477-E6-E8	10,01
E10	E12	144	477-E10-E12	11,04
E14	E18	180	477-E14-E18	12,99
E20	E24	220	477-E20-E24	15,22

Llaves de Estrella Acodadas • Double Ring Wrenches • Clés Polygoneales Contre-coudées

453

De Estrella Acodada
Double Ring Wrench • Polygoneale Contre-coudée

CrV



mm	mm	L mm	Part N°	€
6	7	170	453-06-07	8,12
8	9	183	453-08-09	8,88
8	10	183	453-08-10	9,38
10	11	197	453-10-11	9,44
10	12	198	453-10-12	10,37
12	13	212	453-12-13	10,08
12	14	214	453-12-14	11,70
13	15	222	453-13-15	13,43
13	17	242	453-13-17	11,85
14	15	230	453-14-15	10,92
16	17	245	453-16-17	13,01
17	19	270	453-17-19	15,07
18	19	275	453-18-19	15,11
19	22	315	453-19-22	17,69
20	22	318	453-20-22	17,41
21	23	327	453-21-23	19,75
22	24	327	453-22-24	21,00
24	26	340	453-24-26	24,46
24	27	340	453-24-27	24,67
25	28	347	453-25-28	28,48
27	29	351	453-27-29	31,00
27	30	351	453-27-30	31,59
30	32	365	453-30-32	34,13
32	36	415	453-32-36	60,99
36	41	450	453-36-41	69,99
41	46	506	453-41-46	99,99
46	50	526	453-46-50	110,99

SAE

		L mm	Part N°	€
1/4"	5/16"	170	453-1/4-5/16	8,63
5/16"	3/8"	183	453-5/16-3/8	8,95
3/8"	7/16"	197	453-3/8-7/16	9,62
7/16"	1/2"	212	453-7/16-1/2	10,38
1/2"	9/16"	222	453-1/2-9/16	10,47
9/16"	5/8"	245	453-9/16-5/8	11,48
5/8"	11/16"	246	453-5/8-11/16	13,05
11/16"	3/4"	275	453-11/16-3/4	17,18
13/16"	7/8"	318	453-13/16-7/8	17,47
7/8"	15/16"	327	453-7/8-15/16	23,01
15/16"	1"	340	453-15/16-1	24,23
1"	1/8"	347	453-1-1/8	28,48
1.1/16"	1.1/4	365	453-1.1/16-1.1/4	30,98
1.1/8"	1.1/4	370	453-1.1/8-1.1/4	37,04

Juegos de Llaves de Estrella Acodadas • Double Ring Wrench Sets • Jeux de Clés Polygoneles Contre-coudées

453

Bolsa de Nylon
Nylon Pouch • Trousse Tissu

6

Pcs

CrV



350 x 330 mm



• 6x7 • 8x9 • 10x11 • 12x13 • 14x15 • 16x17

Part N°	€
453-001	63,10
453-001V *	10,57

* Bolsa de Nylon Vacía
Empty Nylon Pouch • Trousse Tissu Vide

453

Bolsa de Nylon
Nylon Pouch • Trousse Tissu

8

Pcs

CrV



390 x 380 mm

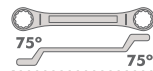

• 6x7 • 8x9 • 10x11 • 12x13 • 14x15
• 16x17 • 18x19 • 20x22

Part N°	€
453-002	95,80
453-002V *	11,27

* Bolsa de Nylon Vacía
Empty Nylon Pouch • Trousse Tissu Vide

453

Bolsa de Nylon
Nylon Pouch • Trousse Tissu

12

Pcs

CrV



620 x 480 mm

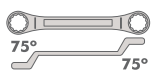

• 6x7 • 8x9 • 10x11 • 12x13 • 14x15 • 16x17
• 18x19 • 20x22 • 21x23 • 24x27 • 25x28 • 30x32

Part N°	€
453-003	203,28
453-003V *	13,07

* Bolsa de Nylon Vacía
Empty Nylon Pouch • Trousse Tissu Vide

453

Bolsa de Nylon
Nylon Pouch • Trousse Tissu

14

Pcs

CrV



620 x 600 mm

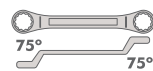

• 6x7 • 8x9 • 10x11 • 12x13 • 14x15
• 16x17 • 18x19 • 20x22 • 21x23 • 24x26
• 25x28 • 30x32 • 32x36 • 36x41

Part N°	€
453-004	335,11
453-004V *	13,77

* Bolsa de Nylon Vacía
Empty Nylon Pouch • Trousse Tissu Vide

Juegos de Llaves de Estrella Acodadas • Double Ring Wrench Sets • Jeux de Clés Polygoneales Contre-coudées

453

Bolsa de Nylon
Nylon Pouch • Trousse Tissu

7

Pcs

SAE

CrV



390 x 380 mm

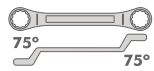

- 1/4" x 5/16" • 5/16" x 3/8" • 3/8" x 7/16"
- 7/16" x 1/2" • 1/2" x 9/16" • 5/8" x 11/16"
- 11/16" x 3/4"

Part N°	€
453-005	81,07
453-005V *	11,17

* Bolsa de Nylon Vacía
Empty Nylon Pouch • Trousse Tissu Vide

453

Bolsa de Nylon
Nylon Pouch • Trousse Tissu

10

Pcs

SAE

CrV



620 x 480 mm

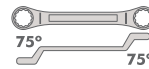

- 1/4" x 5/16" • 5/16" x 3/8" • 3/8" x 7/16"
- 7/16" x 1/2" • 1/2" x 9/16" • 9/16" x 5/8"
- 5/8" x 11/16" • 13/16" x 7/8" • 15/16" x 1"
- 1.1/16" x 1.1/4"

Part N°	€
453-006	148,84
453-006V *	14,26

* Bolsa de Nylon Vacía
Empty Nylon Pouch • Trousse Tissu Vide

453

Caja de Cartón
Carton Box • Étui Carton

8

Pcs

CrV

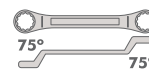

- 6x7 • 8x9 • 10x11 • 12x13 • 14x15
- 16x17 • 18x19 • 20x22

Part N°	€
453-018	96,73

Juegos de Llaves de Estrella Acodadas • Double Ring Wrench Sets • Jeux de Clés Polygonales Contre-coudées

453

Soporte de Plástico
Plastic Holder • Présentoir Plastique

6

Pcs

CrV



• 8x9 • 10x11 • 12x13 • 14x15 • 16x17 • 18x19

Part N°	€
453-016	69,25
450-011V *	8,10

* Soporte de Plástico Vacío
Empty Plastic Holder • Présentoir Plastique Vide

453

Soporte de Plástico
Plastic Holder • Présentoir Plastique

6

Pcs

CrV

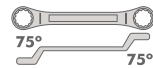

• 6x7 • 8x9 • 10x11 • 12x13 • 14x15 • 16x17

Part N°	€
453-016-2	62,25
450-011V *	8,10

* Soporte de Plástico Vacío
Empty Plastic Holder • Présentoir Plastique Vide

453

Bandeja Combinable
EVA Foam Tray • Panneau de Mousse Modulable

6

Pcs

CrV



1/3 (375 x 188 x 30 mm)

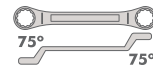

• 8x9 • 10x11 • 12x13 • 14x15 • 16x17 • 18x19

Part N°	€
453-080	76,57

Ver Información Ampliada sobre Almacenaje y Bandejas Combinables en Páginas:

Further Information about Storage and EVA Foam Trays in Pages:

Voir pour Plus d'information sur le Rangement et Panneaux de Mousse Modulables Pages:

10 • 11

452

De Estrella de Impacto
Slogging Ring Wrench • Clé Polygone à Frapper

CrV



mm	L mm	Part N°	€
24	163	452-24	24,08
27	180	452-27	26,64
30	190	452-30	31,57
32	190	452-32	33,94
36	205	452-36	39,20
41	230	452-41	53,28
46	240	452-46	58,13
50	253	452-50	68,33
55	266	452-55	78,15
60	280	452-60	82,39
65	300	452-65	110,39
70	330	452-70	127,66
75	330	452-75	137,09
80	360	452-80	182,38
85	360	452-85	244,23
90	390	452-90	314,26
95	390	452-95	335,92
100	420	452-100	402,97

473

De Media Luna
Half Moon Wrench • Clé Polygone Demi-lune

CrV



mm	mm	L mm	Part N°	€
11	13	149	473-11-13	10,60
14	17	170	473-14-17	11,94
15	16	170	473-15-16	11,98
15	17	170	473-15-17	11,98
19	22	227	473-19-22	15,32

Llaves de Carraca • Gear Wrenches • Clés à Cliquet

Combinadas de Carraca Reversibles • Combination Gear Wrenches • Clés Mixtes à Cliquet Réversibles
457
Combinada de Carraca Reversible
 Combination Gear Wrench • Clé Mixte à Cliquet Réversible

CrV

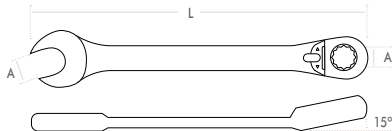
 72°^{15°}

A mm	L mm	Part N°	€
6	120	457-06	19,90
7	120	457-07	19,90
8	134	457-08	19,90
9	158	457-09	20,68
10	158	457-10	22,03
11	164	457-11	23,21
12	167	457-12	24,02
13	177	457-13	25,38
14	189	457-14	26,39
15	198	457-15	27,46
16	204	457-16	28,45
17	224	457-17	29,67
18	245	457-18	31,38
19	245	457-19	31,71
20	280	457-20	37,83
21	280	457-21	33,25
22	280	457-22	35,33
24	310	457-24	40,16
27	330	457-27	63,90
30	425	457-30	82,80
32	280	457-32	89,18

Juegos de Llaves Combinadas de Carraca Reversibles • Combination Gear Wrench Sets • Jeux de Clés Mixtes à Cliquet Réversibles

457

Bolsa de Nylon
Nylon Pouch • Trousse Tissu

7

Pcs

CrV

72^{15°}



330 x 390 mm



• 10 • 12 • 13 • 14 • 15 • 17 • 19

Part N°	€
457-001	189,32
457-001V *	10,57

* Bolsa de Nylon Vacía
Empty Nylon Pouch • Trousse Tissu Vide

457

Soporte de Plástico
Plastic Holder • Présentoir Plastique

5

Pcs

CrV

72^{15°}



• 10 • 12 • 13 • 14 • 15

Part N°	€
457-015	127,09
457-010V *	8,10

* Soporte de Plástico Vacío
Empty Plastic Holder
Présentoir Plastique Vide

457

Soporte de Plástico
Plastic Holder • Présentoir Plastique

7

Pcs

CrV

72^{15°}

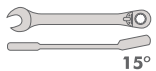

• 10 • 12 • 13 • 14 • 15 • 17 • 19

Part N°	€
457-017	188,47
455-012V *	8,10

* Soporte de Plástico Vacío
Empty Plastic Holder
Présentoir Plastique Vide

457

Caja de Cartón
Carton Box • Étui Carton

5

Pcs

CrV

72^{15°}

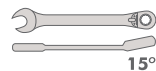

• 10 • 12 • 13 • 14 • 15

Part N°	€
457-035	127,79

Llaves de Carraca • Gear Wrenches • Clés à Cliquet

Juegos de Llaves Combinadas de Carraca Reversibles • Combination Gear Wrench Sets • Jeux de Clés Mixtes à Cliquet Réversibles

457

Caja de Cartón
Carton Box • Étui Carton

6

Pcs

CrV

72^(5°)

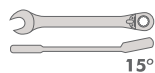

• 10 • 12 • 13 • 14 • 15 • 17

Part N°	€
457-036	157,46

457

Caja de Cartón
Carton Box • Étui Carton

6

Pcs

CrV

72^(5°)

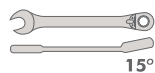

• 10 • 11 • 13 • 14 • 15 • 17

Part N°	€
457-046	156,64

457

Caja de Cartón
Carton Box • Étui Carton

8

Pcs

CrV

72^(5°)

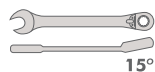

• 8 • 10 • 12 • 13 • 14 • 15 • 17 • 19

Part N°	€
457-038	209,07

457

Bandeja Combinable
EVA Foam Tray • Panneau de Mousse Modulable

10

Pcs

CrV

72^(5°)



1/3 (375 x 188 x 30 mm)

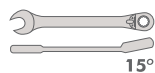

• 10 • 12 • 13 • 14 • 15 • 17 • 19



• 1/4" • 3/8" • 1/2"

Part N°	€
457-080	218,03

Ver Información Ampliada sobre Almacenaje y Bandejas Combinables en Páginas:

Further Information about Storage and EVA Foam Trays in Pages:

Voir pour Plus d'information sur le Rangement et Panneaux de Mousse Modulables Pages:

10 • 11

Llaves de Carraca Reversibles Cortas • Stubby Combination Gear Wrenches • Clés Mixtes à Cliquet Réversibles Courtes

459

Combinada de Carraca Reversible Corta

Stubby Combination Gear Wrench • Clé Mixte à Cliquet Réversible Courte

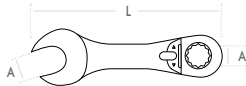

A mm	L mm	Part N°	€
8	93	459-08	18,50
10	95	459-10	18,75
13	106	459-13	20,08
17	125	459-17	24,43
19	138	459-19	27,80

Juegos de Llaves de Carraca Reversibles Cortas • Stubby Combination Gear Wrench Sets • Jeux de Clés Mixtes à Cliquet Réversibles Courtes

459

Soporte de Plástico

Plastic Holder • Présentoir Plastique

5
Pcs



• 8 • 10 • 13 • 17 • 19

Part N°	€
459-015	111,95
459-010V *	10,80

* Soporte de Plástico Vacío

Empty Plastic Holder • Présentoir Plastique Vide

Llaves de Carraca • Gear Wrenches • Clés à Cliquet

 Llaves **Combinadas** de Carraca **Flexibles** • **Flexible** Gear Wrenches • Clés **Mixtes** à **Cliquet Flexibles**
458
Combinada Flexible

Flexible Gear Wrench • Clé Mixte à Cliquet Flexible

CrV

72°



A mm	L mm	Part N°	€
6	136	458-06	30,05
7	136	458-07	30,05
8	136	458-08	22,91
10	158	458-10	22,91
11	175	458-11	23,73
12	175	458-12	25,52
13	185	458-13	27,89
14	193	458-14	29,79
15	215	458-15	36,25
16	215	458-16	36,33
17	231	458-17	35,26
18	249	458-18	39,68
19	249	458-19	37,58
20	280	458-20	42,00
21	280	458-21	38,03
22	280	458-22	43,93
24	310	458-24	50,10

Juegos de Llaves Combinadas de Carraca Flexibles • Flexible Gear Wrench Sets • Jeux de Clés Mixtes à Cliquet Flexibles

458

Soporte de Plástico
Plastic Holder • Présentoir Plastique

5

Pcs

CrV

72^(5°)



• 8 • 10 • 13 • 17 • 19

Part N°	€
458-015	148,34
455-010V *	8,10

* Soporte de Plástico Vacío
Empty Plastic Holder • Présentoir Plastique Vide

458

Caja de Cartón
Carton Box • Étui Carton

5

Pcs

CrV

72^(5°)



• 8 • 10 • 13 • 17 • 19

Part N°	€
458-035	149,04

458

Caja de Cartón
Carton Box • Étui Carton

6

Pcs

CrV

72^(5°)



• 10 • 12 • 13 • 14 • 15 • 17

Part N°	€
458-036	180,11

458

Caja de Cartón
Carton Box • Étui Carton

8

Pcs

CrV

72^(5°)



• 8 • 10 • 12 • 13 • 14 • 15 • 17 • 19

Part N°	€
458-038	240,59

Llaves de Carraca • Gear Wrenches • Clés à Cliquet

Llaves de Carraca Planas • Double Box Flat Gear Wrenches • Clés à Cliquet Plates

456

Plana

Double Box Flat Gear Wrench • Clé à Cliquet Plate

CrV

72°

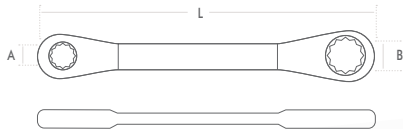

mm	mm	L mm	Part N°	€
6	7	115	456-06-07	16,95
7	8	115	456-07-08	16,95
8	9	130	456-08-09	16,95
10	11	145	456-10-11	18,79
12	13	166	456-12-13	23,75
14	15	181	456-14-15	24,68
16	18	205	456-16-18	26,69
17	19	225	456-17-19	27,44
20	22	255	456-20-22	45,00

Juegos de Llaves de Carraca Planas • Double Box Flat Gear Wrench Sets • Jeux de Clés à Cliquet Plates

456

Soporte de Plástico

Plastic Holder • Présentoir Plastique

5
Pcs

CrV

72°



• 6x7 • 8x9 • 10x11 • 12x13 • 14x15

Part N°	€
456-015	102,92
455-010V *	8,10

* Soporte de Plástico Vacío
Empty Plastic Holder • Présentoir Plastique Vide

Juegos de Llaves de Carraca Planas • Double Box Flat Gear Wrench Sets • Jeux de Clés à Cliquet Plates

456

Caja de Cartón
Carton Box • Étui Carton

5

Pcs

CrV

72^(5°)



• 8x9 • 10x11 • 12x13 • 14x15 • 16x18

Part N°	€
456-035	113,36

456

Caja de Cartón
Carton Box • Étui Carton

6

Pcs

CrV

72^(5°)



• 8x9 • 10x11 • 12x13 • 14x15 • 16x18 • 17x19

Part N°	€
456-036	140,80

Llaves de Carraca Doble Boca Torx Plana • Double E Socket Gear Wrenches • Clés Torx à Cliquet Plates

474

Doble Boca Torx (E) Plana de Carraca
Double E Socket Gear Wrench • Clé Torx à Cliquet Plate

CrV

72^(5°)

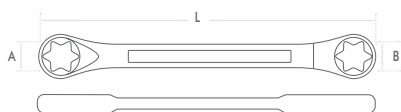

		L mm	Part N°	€
E6	E8	130	474-E6-E8	22,09
E10	E12	144	474-E10-E12	23,11
E14	E18	180	474-E14-E18	28,55
E20	E24	220	474-E20-E24	34,22

Llaves de Carraca • Gear Wrenches • Clés à Cliquet

Llaves de Carraca Reversibles Acodadas • Double Box 15° Gear Wrenches • Clés à Cliquet Réversibles Coudées à 15°

455

Reversible Acodada

Double Box 15° Gear Wrench • Cliquet Réversible Coudée à 15°

CrV

72^{15°}

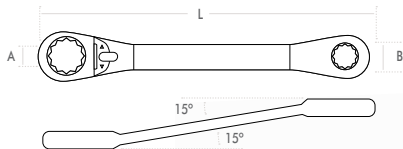

SAE

mm	mm	L mm	Part N°	€
6	7	115	455-06-07	28,35
8	9	130	455-08-09	28,35
8	10	130	455-08-10	28,35
10	11	145	455-10-11	30,01
10	12	145	455-10-12	30,01
10	13	145	455-10-13	32,16
12	13	166	455-12-13	33,13
12	14	166	455-12-14	33,13
14	15	180	455-14-15	33,50
14	17	180	455-14-17	36,86
16	17	205	455-16-17	36,86
16	18	205	455-16-18	36,86
17	19	225	455-17-19	38,34

mm	mm	L mm	Part N°	€
1/4"	5/16"	115	455-1/4-5/16	27,01
3/8"	7/16"	145	455-3/8-7/16	29,01
1/2"	9/16"	166	455-1/2-9/16	32,22

Juegos de Llaves Carraca Reversibles Acodadas • Double Box 15° Gear Wrench Sets • Jeux de Clés à Cliquet Réversibles Coudées à 15°

455

Bolsa de Nylon

Nylon Pouch • Trousse Tissu

6

Pcs

CrV

72^{15°}



300 x 390 mm

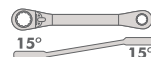

• 8x9 • 10x11 • 12x13 • 14x15 • 16x18 • 17x19

Part N°	€
455-001	202,84
455-001V *	10,57

* Bolsa de Nylon Vacía

Empty Nylon Pouch • Trousse Tissu Vide

Juegos de Llaves Carraca Reversibles Acodadas • Double Box 15° Gear Wrench Sets • Jeux de Clés à Cliquet Réversibles Coudées à 15°

455

Caja de Cartón
Carton Box • Étui Carton

5

Pcs

CrV

72^(15°)



15° 15° • 8x9 • 10x11 • 12x13 • 14x15 • 16x18

Part N°

€

455-035 164,35

455

Caja de Cartón
Carton Box • Étui Carton

6

Pcs

CrV

72^(15°)



15° 15° • 8x9 • 10x11 • 12x13 • 14x15 • 16x18 • 17x19

Part N°

€

455-036 202,69

455

Soporte de Plástico
Plastic Holder • Présentoir Plastique

5

Pcs

CrV

72^(15°)



15° 15° • 8x9 • 10x11 • 12x13 • 14x15 • 16x18

Part N°

€

455-015 163,65

455-010V * 8,10

* Soporte de Plástico Vacío
Empty Plastic Holder • Présentoir Plastique Vide

455

Soporte de Plástico
Plastic Holder • Présentoir Plastique

7

Pcs

CrV

72^(15°)



15° 15° • 6x7 • 8x9 • 10x11 • 12x13 • 14x15 • 16x18 • 17x19

Part N°

€

455-017 230,34

455-012V * 8,10

* Soporte de Plástico Vacío
Empty Plastic Holder • Présentoir Plastique Vide

455

Bandeja Combinable • EVA Foam Tray • Panneau de Mousse Modulable

9

Pcs

CrV

72^(15°)



15° 15° • 8x9 • 10x11 • 12x13 • 14x15 • 16x18 • 17x19

• 1/4" • 3/8" • 1/2"

1/3 (375 x 188 x 30 mm)

Part N°

€

455-080 231,55

Ver Información Ampliada de las bandejas Combinables • Further Information about EVA Foam Trays • Voir pour Plus d'information de Panneaux Modulables

p. 10 • 11

Llaves de Carraca • Gear Wrenches • Clés à Cliquet

Llaves de Carraca 4 en 1 • 4 in 1 Gear Wrenches • Clés à Cliquet 4 en 1

475

Carraca 4 en 1

4 in 1 Gear Wrench • Clé à Cliquet 4 en 1

CrV

72°^{5°}

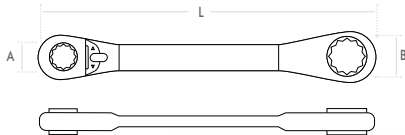

mm	mm	L mm	Part N°	€
8x10	12x13	165	475-08-13	24,30
9x11	14x15	180	475-09-15	28,43
16x17	18x19	225	475-16-19	30,15

Juegos de Llaves de Carraca 4 en 1 • 4 in 1 Gear Wrench Sets • Jeux de Clés à Cliquet 4 en 1

475

Bolsa de Nylon

Nylon Pouch • Trousse Tissu

3

Pcs

CrV

72°^{5°}



220 x 330 mm



- 8x10 12x13
- 9x11 14x15
- 16x17 18x19

Part N°	€
475-001	85,04
475-001V *	8,68

* Bolsa de Nylon Vacía

Empty Nylon Pouch • Trousse Tissu Vide

Accesorios para Llaves de Carraca • Accesories for Gear Wrenches • Accessoires pour Clés à Cliquet

476

Cuadradillo de Arrastre
Square Drive • Adaptateur pour Douilles

CrV



□	○ mm	Part N°	€
1/4"	10	476-1/4-10	6,52
3/8"	13	476-3/8-13	7,25
1/2"	19	476-1/2-19	8,47
3/4"	32	476-3/4-32	22,18

476

Portapuntas
Bit Holder • Adaptateur pour Embouts de Vissage

CrV



○	○ mm	Part N°	€
1/4"	10	476-1/4P-10	2,45
5/16"	13	476-5/16P-13	4,10
10 mm	19	476-10P-19	4,97

Llaves Fijas • Wrenches • Clés Fixes

Llaves de **Tubo Hexagonal** y **Barra** de Repuesto • **Hex Socket** Wrenches & Spare **Bar** • Clés à **Béquille** et **Tige** de Rechange

460

Llave de Tubo Hexagonal
Double Ended Hex Socket Wrench
Clé à Béquille Double Forjée

CrV



Ø mm	Ø mm	L mm	Part N°	€
6	7	105	460-06-07	10,92
8	9	110	460-08-09	11,06
10	11	120	460-10-11	11,71
12	13	140	460-12-13	13,74
14	15	145	460-14-15	15,39
16	17	155	460-16-17	17,93
18	19	165	460-18-19	21,44
20	22	170	460-20-22	24,43
21	23	185	460-21-23	27,18
24	26	190	460-24-26	33,83
25	28	205	460-25-28	38,83
27	29	210	460-27-29	44,34
30	32	210	460-30-32	48,01

460

Barra para Llave de Tubo Hexagonal
Double Ended Hex Socket Wrench Bar
Tige pour Clé à Béquille Double Forjée



Ø mm	Ø mm	Ø mm	Part N°	€
2,5	6	7	460-01	1,88
	8	9		
4,5	10	11	460-02	2,88
	12	13		
5,5	14	15	460-03	3,13
	16	17		
6,5	18	19	460-04	4,38
	20	22		
7,5	21	23	460-05	5,50
	24	26		
9,5	25	28	460-06	6,63
	27	29		
11,5	30	32	460-07	7,75
12,5			460-08	9,75

Juegos de Llaves de Tubo Hexagonal • Double Ended Hex Socket Wrench Sets • Jeux de Clés à Béquille Double Forjée

460

Bandeja Combinable
EVA Foam Tray • Panneau de Mousse Modulable

8
Pcs

CrV



1/4 (375 x 140 x 30 mm)

• 6x7 • 8x9 • 10x11 • 12x13 • 14x15
• 16x17 • 18x19 • 20x22

Part N°	€
460-080	133,00

Juegos de Llaves de Tubo Hexagonal • Double Ended Hex Socket Wrench Sets • Jeux de Clés à Béquille Double Forcée

460

Bolsa de Nylon
Nylon Pouch • Trousse Tissu

6

Pcs

CrV



330 x 350 mm



• 6x7 • 8x9 • 10x11 • 12x13 • 14x15 • 16x17

Part N°	€
460-001	83,30
460-001V *	10,17

* Bolsa de Nylon Vacía
Empty Nylon Pouch • Trousse Tissu Vide

460

Bolsa de Nylon
Nylon Pouch • Trousse Tissu

8

Pcs

CrV



430 x 380 mm



• 6x7 • 8x9 • 10x11 • 12x13 • 14x15 • 16x17
• 18x19 • 20x22

Part N°	€
460-002	129,42
460-002V *	11,17

* Bolsa de Nylon Vacía
Empty Nylon Pouch • Trousse Tissu Vide

460

Bolsa de Nylon
Nylon Pouch • Trousse Tissu

10

Pcs

CrV



480 x 380 mm



• 6x7 • 8x9 • 10x11 • 12x13 • 14x15 • 16x17
• 18x19 • 20x22 • 21x23 • 24x26

Part N°	€
460-003	190,43
460-003V *	11,17

* Bolsa de Nylon Vacía
Empty Nylon Pouch • Trousse Tissu Vide

460

Bolsa de Nylon
Nylon Pouch • Trousse Tissu

12

Pcs

CrV



520 x 390 mm



• 6x7 • 8x9 • 10x11 • 12x13 • 14x15 • 16x17
• 18x19 • 20x22 • 21x23 • 24x26 • 25x28 • 30x32

Part N°	€
460-004	277,55
460-004V *	12,27

* Bolsa de Nylon Vacía
Empty Nylon Pouch • Trousse Tissu Vide

Llaves Fijas • Wrenches • Clés Fixes

Llaves de **Tubo Redondo** • **Tubular Socket Wrenches** • **Clés à Béquille**

461

Llave de Tubo Redondo

Double Ended Tubular Socket Wrench • Clé à Béquille Double

Barra • Bar • Tige

CrV



mm	mm	L mm	Part N°	€	Part N°	€
6	7	110	461-06-07	4,69	460-04	4,38
8	9	110	461-08-09	5,18		
10	11	120	461-10-11	6,03		
12	13	140	461-12-13	6,52		
14	15	140	461-14-15	7,06		
16	17	150	461-16-17	7,62		
18	19	160	461-18-19	9,12	460-05	5,50
20	22	170	461-20-22	10,29		
21	23	170	461-21-23	11,54		
24	26	190	461-24-26	12,48		
25	28	190	461-25-28	15,71		
27	29	195	461-27-29	17,31		
30	32	210	461-30-32	17,31	460-06	6,63
36	38	165	461-36-38	17,51		

Juegos de Llaves de Tubo Redondo • Double Ended Tubular Socket Wrench Sets • Jeux de Clés à Béquille Doubles

461

Bolsa de Nylon

Nylon Pouch • Trousse Tissu

8

Pcs

CrV



380 x 400 mm



• 6x7 • 8x9 • 10x11 • 12x13 • 14x15 • 16x17
• 18x19 • 20x22

Part N°	€
461-001	59,30
461-001V *	11,17

* Bolsa de Nylon Vacía
Empty Nylon Pouch • Trousse Tissu Vide

461

Bolsa de Nylon

Nylon Pouch • Trousse Tissu

12

Pcs

CrV



520 x 390 mm



• 6x7 • 8x9 • 10x11 • 12x13 • 14x15 • 16x17
• 18x19 • 20x22 • 21x23 • 24x26 • 25x28 • 30x32

Part N°	€
461-002	116,62
461-002V *	12,27

* Bolsa de Nylon Vacía
Empty Nylon Pouch • Trousse Tissu Vide

462

Llave de Pipa Abierta 6x6
6x6 Angled Open Socket Wrench
Clé à Pipe Débouchée Foragée 6 Pans x 6 Pans

CrV

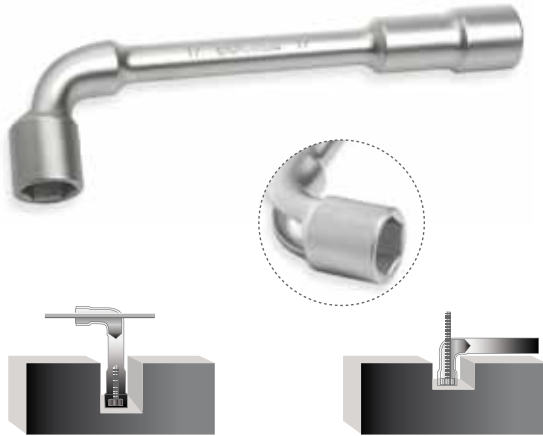

Ø mm	L mm	Part N°	€
6	110	462-06	8,78
7	114	462-07	9,10
8	120	462-08	9,90
9	125	462-09	10,16
10	131	462-10	10,74
11	137	462-11	10,94
12	144	462-12	11,57
13	153	462-13	12,73
14	160	462-14	13,68
15	174	462-15	14,73
16	185	462-16	16,20
17	197	462-17	17,14
18	211	462-18	18,30
19	218	462-19	19,04
20	222	462-20	20,83
21	231	462-21	22,97
22	247	462-22	24,09
23	255	462-23	27,54
24	266	462-24	32,76
25	278	462-25	36,35
26	289	462-26	40,53
27	299	462-27	44,24
28	310	462-28	48,54
29	319	462-29	51,77
30	332	462-30	54,52
32	353	462-32	56,91

465

Llave de Rueda
"L" Type Handle • Clé Pour Roue

CrV

1/2"



Ø	L mm	Part N°	€
1/2"	300	465-1/2-300	13,23

CrV

3/4"



Ø	L mm	Part N°	€
3/4"	300	465-3/4-300	20,99
3/4"	450	465-3/4-450	28,03

Llaves de Vaso Articuladas Dobles • Double Flexible Socket Wrenches • Clés à Douilles Articulées

467

Llave de Vaso Articulada Doble
Double Flexible Socket Wrench • Clé à Douilles Articulées

CrV



mm	mm	L mm	Part N°	€
6	7	195	467-06-07	14,30
8	9	195	467-08-09	14,30
10	11	210	467-10-11	14,73
12	13	225	467-12-13	17,50
14	15	245	467-14-15	19,66
16	17	260	467-16-17	22,52
18	19	275	467-18-19	26,17
20	22	300	467-20-22	32,99
21	23	300	467-21-23	34,43
24	27	325	467-24-27	38,12

467

Bolsa de Nylon
Nylon Pouch • Trousse Tissu

7
Pcs

CrV



330 x 390 mm

• 8x9 • 10x11 • 12x13 • 14x15 • 16x17
• 18x19 • 20x22

Part N°	€
467-001	150,67
467-001V *	11,17

* Bolsa de Nylon Vacía
Empty Nylon Pouch • Trousse Tissu Vide

467

Bandeja Combinable
EVA Foam Tray • Panneau de Mousse Modulable

6
Pcs

CrV



1/3 (375 x 188 x 30 mm)

• 8x9 • 10x11 • 12x13 • 14x15 • 16x17 • 18x19

Part N°	€
467-080	124,01

Ver Información Ampliada sobre Almacenaje y Bandejas Combinables en Páginas:
Further Information about Storage and EVA Foam Trays in Pages:
Voir pour Plus d'information sur le Rangement et Panneaux de Mousse Modulables Pages:

Llaves en Cruz y Tipo "T" • Lug and Flexible Socket Wrenches • Clés en Croix et à Bougie

466

Llave en Cruz

4 Way Lug Wrench • Clé en Croix

CrV



mm	mm	L mm	Part N°	€
1/2"	17x19x22	375	466-1/2-375	33,63
3/4"	24x27x32	625	466-3/4-625	122,45

468

Llave de Vaso Articulada Tipo "T" para Bujías

"T" Type Spark Plug Flexible Socket Wrench • Clé à Bougie Articulée

CrV



mm	L mm	Part N°	€
16	300	468-16-300	25,29
21	300	468-21-300	26,26

469

Llave de Vaso Articulada Tipo "T"

"T" Type Universal Flexible Socket Wrench • Clé à Béquille Articulée

CrV



mm	L mm	Part N°	€
6	390	469-06-390	24,58
8	390	469-08-390	24,58
10	500	469-10-500	27,39
12	500	469-12-500	27,39
13	500	469-13-500	27,39
17	500	469-17-500	30,99
19	500	469-19-500	34,62

Llaves **Articuladas de Pivote** • **Hook Wrenches** • **Clés à Crochet**
471
Llave Articulada de Pivote Fijo
Fixed Hook Wrench • Clé à Crochet

CrV



 mm	L mm	Part N°	€
13~35	168	471-13-35	25,95
35~50	202	471-35-50	28,27
50~80	280	471-50-80	38,78
80~120	345	471-80-120	50,25
120~180	492	471-120-180	69,12

472
Llave Articulada de Pivote Intercambiable
Pin Hook Wrench • Clé à Ergot Avec Téton Interchangeable

CrV



 mm	L mm	Part N°	€
13~35	168	472-13-35	27,71
35~50	202	472-35-50	30,63
50~80	280	472-50-80	39,90
80~120	345	472-80-120	53,56
120~180	492	472-120-180	71,68

472
Pivote Intercambiable de Repuesto
Spare Pin • Téton de Rechange

CrV



 mm	Ø mm	Part N°	€
13~35	3	472-0	2,70
35~50	4	472-1	3,11
50~80	5	472-2	3,86
80~120	6	472-3	4,26
120~180	8	472-4	5,23

Llaves para Carter • Oil Drain Plug Key Wrenches • Clés Pour Carter

482

Llave para Tapón de Carter

S-Type Oil Drain Plug Key Wrench • Clé Pour Bouchon de Carter

CrV

8 mm

10 mm

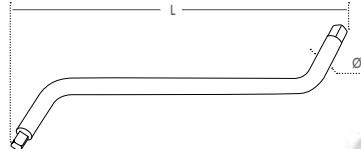

mm	mm	L mm	Ø mm	Part N°	€
8	10	255	12	482-001	9,75

- Para tapones de carter de aceite y caja de cambios en vehiculos Citroën, Peugeot, Renault, Volvo...
- For oil crank and gear box plugs in Citroën, Peugeot, Renault, Volvo...
- Pour Bouchons de carter d'huile et Boîte de vitesse pour Citroën, Peugeot, Renault, Volvo...

482

Llave Reforzada para Tapón de Carter

S-Type Heavy Duty Oil Drain Plug Key Wrench • Clé Renforcée Pour Bouchon de Carter

CrV

8 mm

10 mm

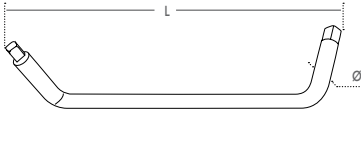

mm	mm	L mm	Ø mm	Part N°	€
8	10	235	13	482-002	15,66

- Para tapones de carter de aceite y caja de cambios en vehiculos Citroën, Peugeot, Renault, Volvo...
- For oil crank and gear box plugs in Citroën, Peugeot, Renault, Volvo...
- Pour Bouchons de carter d'huile et Boîte de vitesse pour Citroën, Peugeot, Renault, Volvo...

482

Llave Reforzada con vaso para Tapón de Carter

S-Type Heavy Duty Oil Drain Plug Key & Socket Wrench • Clé Renforcée avec Douille Pour Bouchon de Carter

CrV

8 mm

11 mm

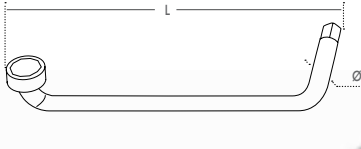

mm	mm	L mm	Ø mm	Part N°	€
8	11	250	12	482-003	17,88

- Para tapones de carter de aceite y caja de cambios en vehiculos Citroën, Peugeot, Renault, Volvo...
- For oil crank and gear box plugs in Citroën, Peugeot, Renault, Volvo...
- Pour Bouchons de carter d'huile et Boîte de vitesse pour Citroën, Peugeot, Renault, Volvo...

Llaves de Filtro • Oil Filter Wrenches • Clés à Filtre

Llaves de Filtro • Oil Filter Wrenches • Clés à Filtre

481

Llave de Filtro con Banda Metálica
Oil Filter Belt Wrenches • Clé à Filtre à Bande Métallique



mm	Part N°	€
65~105	481-65-105	21,13
110~165	481-110-165	22,45

• Para cambio de fleje soltar el tornillo de la base giratoria.
Remove the screw at the rotary rear end to replace the belt.
Retirer la vis de la base giratoire pour remplacer le ruban.

481

Llave de Filtro Ajustable en 3 Posiciones
Adjustable 3 position Oil Filter Wrench • Clé à Filtre Auto-Réglable 3 Positions



mm	Part N°	€
85~115	481-85-115	24,70

Repuestos • Spare Parts • Rechanges

481R

Banda Metálica de Repuesto
Oil Filter Spare Belt • Bande Métallique de Rechange

Apta para • Suitable for • Apte pour
481-65-105 / 481-110-165



mm	Part N°	€
65~105	481-65-105R	6,25
110~165	481-110-165R	7,00

Llaves de Vaso
Sockets
Douilles



1/4"		184
3/8"		199
1/2"		210
3/4"		233
1"		238
3/8"		240
1/2"		
3/4"		
1"		
1.1/2"		251
2.1/2"		
3.1/2"		

1/4"

500

Hexagonal • Hexagonal • Hexagonale



Ø mm	L mm	Part N°	€
4	25	500-04	3,53
4,5	25	500-04,5	3,53
5	25	500-05	3,53
5,5	25	500-05,5	3,53
6	25	500-06	3,53
7	25	500-07	3,53
8	25	500-08	3,53
9	25	500-09	3,53
10	25	500-10	3,53
11	25	500-11	3,53
12	25	500-12	3,58
13	25	500-13	3,58
14	25	500-14	3,58

501

Bihexagonal • Bihexagonal • Bi-Hexagonale



Ø mm	L mm	Part N°	€
4	25	501-04	3,53
4,5	25	501-04,5	3,53
5	25	501-05	3,53
5,5	25	501-05,5	3,53
6	25	501-06	3,53
7	25	501-07	3,53
8	25	501-08	3,53
9	25	501-09	3,53
10	25	501-10	3,53
11	25	501-11	3,53
12	25	501-12	3,58
13	25	501-13	3,58
14	25	501-14	3,58

SAE

Ø	L mm	Part N°	€
5/32"	25	500-5/32	3,53
3/16"	25	500-3/16	3,53
7/32"	25	500-7/32	3,53
1/4"	25	500-1/4	3,53
9/32"	25	500-9/32	3,53
5/16"	25	500-5/16	3,53
11/32"	25	500-11/32	3,53
3/8"	25	500-3/8	3,58
7/16"	25	500-7/16	3,58
1/2"	25	500-1/2	3,58
9/16"	25	500-9/16	3,58

1/4"

502

Hexagonal Serie Larga

Hexagonal Long Series • Hexagonale Série Longue



mm	L mm	Part N°	€
4	50	502-04	6,40
4,5	50	502-04,5	6,40
5	50	502-05	6,40
5,5	50	502-05,5	6,40
6	50	502-06	6,40
7	50	502-07	6,40
8	50	502-08	6,40
9	50	502-09	6,40
10	50	502-10	6,40
11	50	502-11	6,40
12	50	502-12	6,88
13	50	502-13	6,88
14	50	502-14	6,88

503

Torx • Torx • Torx



	L mm	Part N°	€
E4	25	503-T04	4,03
E5	25	503-T05	4,03
E6	25	503-T06	4,03
E7	25	503-T07	4,03
E8	25	503-T08	4,03
E10	25	503-T10	4,03

1/4"

Llaves de Vaso con Punta • Socket Bits • Douilles - Embout de Vissage

504

Punta Recta • Slot • Plat

1/4"

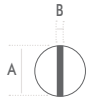

S2

A mm	B mm	L mm	Part N°	€
4	0,8	37	504-040	4,98
5,5	1	37	504-055	4,98
6,5	1,2	37	504-065	4,98
8	1,2	37	504-080	4,98

505

Punta Phillips • Phillips • Phillips

1/4"



S2



	L mm	Part N°	€
PH1	37	505-PH1	4,98
PH2	37	505-PH2	4,98
PH3	37	505-PH3	4,98

506

Punta Pozidriv • Pozidriv • Pozidriv

1/4"



S2



	L mm	Part N°	€
PZ1	37	506-PZ1	4,98
PZ2	37	506-PZ2	4,98
PZ3	37	506-PZ3	4,98

507

Punta Hexagonal • Hexagonal • Hexagonal

1/4"



S2



	L mm	Part N°	€
HX3	37	507-03	4,98
HX4	37	507-04	4,98
HX5	37	507-05	4,98
HX6	37	507-06	4,98
HX7	37	507-07	4,98
HX8	37	507-08	4,98

Llaves de Vaso con Punta • Socket Bits • Douilles - Embout de Vissage

1/4"

508

Punta Torx • Torx • Torx

1/4"



S2



	L mm	Part N°	€
T6	37	508-T06	5,63
T7	37	508-T07	5,63
T8	37	508-T08	5,63
T9	37	508-T09	5,63
T10	37	508-T10	5,63
T15	37	508-T15	5,63
T20	37	508-T20	5,63
T25	37	508-T25	5,63
T27	37	508-T27	5,63
T30	37	508-T30	5,63
T40	37	508-T40	5,63

Accesorios para Llaves de Vaso • Accessories for Sockets • Accessoires pour Douilles

509

Alargador • Extension • Rallonge

1/4"

CrV



L mm	Part N°	€
50	509-001	6,40
75	509-002	8,25
100	509-003	9,18
150	509-004	11,13
250	509-005	14,45

509

Alargador Angular
Wobble Extension • Rallonge Angulaire

1/4"

CrV



L mm	Part N°	€
50	509-006	8,00
150	509-007	9,73

509

Alargador Flexible
Flexible Extension • Rallonge Flexible

1/4"

CrV



L mm	Part N°	€
145	509-008	14,13

1/4"

Accesorios para Llaves de Vaso • Accessories for Sockets • Accessoires pour Douilles

509

Articulación Universal
Universal Joint • Cardan Universel

1/4"
CrV



Part N°	€
509-009	17,80

509

Adaptador Ampliador
Increasing Adaptor • Augmentateur

1/4"
3/8"
CrV



1/4"	3/8"	Part N°	€
		509-011	7,48

509

Portapuntas con Cuadrado de Arrastre
Square Drive Bit Holders
Douille Porte-Embouts à Jonc de Retenue

1/4"
1/4"
CrV



1/4"	1/4"	Part N°	€
		509-012	6,25

509

Adaptador Apriete Manual Espacios Confinados
Multi-Function Palm Driver
Adaptateur Serrage Manuel pour Accès Difficiles

1/4"
1/4"
CrV



1/4"	Part N°	€
	509-013	7,45

509

Mango Corredizo en "T"
Sliding "T" Handle • Manche en "T" à Glissement

1/4"
CrV



1/4"	L mm	Part N°	€
	115	509-014	9,00

509

Repuesto de Barra para Mango Corredizo en "T"
Spare Bar for Sliding "T" Handle
Rechange pour Manche en "T" à Glissement

CrV



L mm	Part N°	€
115	509-015	6,12

Accesorios para Llaves de Vaso • Accessories for Sockets • Accessoires pour Douilles

1/4"

509

Destornillador Flexible • Flexible Spinner Handle • Tournevis Flexible

1/4"

CrV



	L mm	Part N°	€
1/4"	150	509-016	12,04

509

Destornillador con Cuadradillo • Spinner Handle • Tournevis à Carré d'entraînement

1/4"

CrV



	L mm	Part N°	€
1/4"	150	509-017	9,53

509

Mango en "T" • "T" Handle • Manche en "T"

1/4"

CrV



	L mm	Part N°	€
1/4"	135	509-018	15,85

509

Adaptador Mango Hexagonal para Vasos
Hexagonal Shank Socket Adaptor
Adaptateur Porte-Douille

1/4"

1/4"

CrV



		L mm	Part N°	€
1/4"	1/4"	65	509-019	6,40

509

Mango Corredizo en "T" con Tope Lateral
Sliding "T" Handle with Side Stopper
Manche en T à Glissement avec Butée de Côté

1/4"

CrV



	L mm	Part N°	€
1/4"	110	509-025	9,73

509

Adaptador Espacios Confinados
Rolling Joint • Adaptateur pour Accès Difficiles

1/4"

CrV



	Part N°	€
1/4"	509-020	8,63

Llaves de Vaso • Sockets • Douilles

1/4"

Llaves de Carraca • Ratchet Handles • Cliquets

510

Llave de Carraca • Ratchet Handle • Cliquet

1/4"

72^{5°}

CrV



TH	L mm	Part N°	€
72 TH	145	510-001	22,98

510

Llave de Carraca Corta • Stubby Ratchet Handle • Cliquet Court

1/4"

72^{5°}

CrV



TH	L mm	Part N°	€
72 TH	108	510-002	18,87

510

Llave de Carraca Extensible • Extendable Ratchet Handle • Cliquet Extensible

1/4"

72^{5°}

CrV



TH	L mm	Part N°	€
72 TH	160~205	510-003	30,23

510

Llave de Carraca Cambio Rápido • One Hand Switch Ratchet Handle • Cliquet Changement Rapide

1/4"

60^{6°}

CrV



TH	L mm	Part N°	€
60 TH	150	510-004	34,48

Juegos de Llaves de Vaso • Socket Sets • Jeux de Douilles

1/4"

500

Hexagonal • Hexagonal • Hexagonale

10
Pcs

1/4"



5 • 6 • 7 • 8 • 9 • 10 • 11 • 12 • 13 • 14

Part N°	€
500-051	35,96

500

Hexagonal y Llave de Carraca
Hexagonal and Ratchet Handle
Hexagonale et Cliquet

11
Pcs

1/4"



5 • 6 • 7 • 8 • 9 • 10 • 11 • 12 • 13 • 14

Part N°	€
500-061	59,32

500

Hexagonal, Llave de Carraca y Alargador
Hexagonal, Ratchet Handle and Extension
Hexagonale, Cliquet et Rallonge

15
Pcs

1/4"



4 • 4,5 • 5 • 5,5 • 6 • 7 • 8 • 9 • 10 • 11 • 12 • 13 • 14

72 dientes • 72 teeth • 72 dents

100 mm

Part N°	€
500-071	79,20

501

Bihexagonal • Bihexagonal • Bi-Hexagonale

10
Pcs

1/4"



5 • 6 • 7 • 8 • 9 • 10 • 11 • 12 • 13 • 14

Part N°	€
501-051	35,96

1/4"

Juegos de Llaves de Vaso • Socket Sets • Jeux de Douilles

501

Bihexagonal y Llave de Carraca
Bihexagonal and Ratchet Handle
Bi-Hexagonale et Cliquet

11
Pcs

1/4"



5 · 6 · 7 · 8 · 9 · 10 · 11 · 12 · 13 · 14

72 dientes • 72 teeth • 72 dents

Part N°	€
501-061	59,32

502

Hexagonal Serie Larga
Hexagonal Long Series • Hexagonale Série Longue

10
Pcs

1/4"



4 · 5 · 6 · 7 · 8 · 9 · 10 · 11 · 12 · 13

Part N°	€
502-051	65,51

503

Torx • Torx • Torx

14
Pcs

1/4"



E4 · E5 · E6 · E7 · E8 · E10

T8 · T9 · T10 · T15 · T20 · T25 · T27 · T30

Part N°	€
503-052	69,71

507

Punta Torx y Hexagonal
Torx and Hexagonal • Torx et Hexagonal

11
Pcs

1/4"



HX3 · HX4 · HX5 · HX6 · HX8

T8 · T9 · T10 · T15 · T20 · T25

Part N°	€
507-051	59,18

Juegos de Llaves de Vaso • Socket Sets • Jeux de Douilles

1/4"

507

Punta Recta, Hexagonal y Phillips
Slot, Hexagonal and Phillips • Plat, Hexagonal et Phillips

12
Pcs

1/4"



4 • 5,5 • 6,5 • 8

PH1 • PH2 • PH3

HX3 • HX4 • HX5 • HX6 • HX8

Part N°

€

507-052

60,26

500

Maletín Vaso Hexagonal
Hexagonal Socket Case • Coffret de Douilles Hexagonales

17
Pcs

1/4"



260 x 167 x 62 mm

Vasos • Sockets • Douilles

4 • 4,5 • 5 • 5,5 • 6 • 7 • 8 • 9 • 10 • 11 • 12 • 13 • 14

Llave de Carraca • Ratched Handle • Cliquet

72 dientes
72 teeth • 72 dents



Alargador • Extension • Rallonge

50 mm



Destornillador Triple Cuadrado

3 - Way Spinner Handle
Tournevis avec Triple Carré d'entraînement



Articulación Universal

Universal Joint
Cardan Universel



Part N°

€

500-001

73,28

1/4"

Juegos de Llaves de Vaso • Socket Sets • Jeux de Douilles

500

Maletín Vaso Hexagonal
Hexagonal Socket Case • Coffret de Douilles Hexagonales

34

Pcs

1/4"



260 x 167 x 62 mm

Vasos • Sockets • Douilles

4 • 4,5 • 5 • 5,5 • 6 • 7 • 8 • 9 • 10 • 11 • 12 • 13 • 14

Puntas de Atornillar • Screwdriver Bits • Embouts de Vissage

HX3 • HX4
HX5 • HX6

T10 • T15
T20 • T25

PH1 • PH2
PH3

4 • 5,5 • 6,5

Llave de Carraca

Ratched Handle • Cliquet



72 dientes
72 teeth • 72 dents

Destornillador Triple Cuadrado

3 - Way Spinner Handle

Tournevis avec Triple Carré d'entraînement



Adaptador Espacios Confinados

Palm Driver • Adaptateur pour Accès Difficiles



Portapuntas Cuadrado de Arrastre

Square Drive Bit Holder • Douille Porte-embouts à Carré d'entraînement

1/4" ▶ ◀ 1/4"

Articulación Universal

Universal Joint • Cardan Universel



Alargador Flexible

Flexible Extension

Rallonge Flexible



145 mm

Alargador

Extension • Rallonge



50 mm

Part N°

€

500-002

104,86

500

Maletín Vaso Hexagonal
Hexagonal Socket Case • Coffret de Douilles Hexagonales

47

Pcs

1/4"



260 x 167 x 62 mm

Vasos • Sockets • Douilles

4 • 4,5 • 5 • 5,5 • 6 • 7 • 8 • 9 • 10
11 • 12 • 13 • 14

Serie Larga • Deep • Série Longue

8 • 10 • 11 • 13

Vasos con Puntas • Socket Bits • Douilles-Embouts de Vissage

HX3 • HX4 • HX5 • HX6 • HX7 • HX8

T10 • T15 • T20 • T25 • T30 • T40

PZ1 • PZ2
PZ3

PH1 • PH2
PH3

4 • 5,5 • 6,5

Llave de Carraca • Ratched Handle • Cliquet



72 dientes
72 teeth • 72 dents

Destornillador • Spinner Handle • Tournevis



Llaves Allen • Hex Key Wrenches • Clés Allen



1,5 • 2 • 2,5

Alargadores • Extensions • Rallonges



100 mm

50 mm

Articulación Universal

Universal Joint • Cardan Universel



Mango Corredizo en "T"

Sliding "T" Handle • Manche en "T" à Glissement



Part N°

€

500-003

181,79

Juegos de Llaves de Vaso • Socket Sets • Jeux de Douilles

1/4"

500

Maletín Vaso Hexagonal (SAE)

Hexagonal Socket Case (SAE) • Coffret de Douilles Hexagonales (SAE)

16

SAE

Pcs

1/4"



260 x 167 x 62 mm

Vasos • Sockets • Douilles

5/32" • 3/16" • 7/32" • 1/4" • 9/32" • 5/16" • 11/32" • 3/8" • 7/16"
15/32" • 1/2" • 9/16"

Llave de Carraca

Ratcheted Handle • Cliquet



72 dientes
72 teeth • 72 dents

Articulación Universal

Universal Joint • Cardan Universel



Destornillador Triple Cuadradillo

3 - Way Spinner Handle
Tournevis avec Triple Carré d'entraînement



Alargador

Extension • Rallonge



50 mm

Part N°

€

500-004

70,88

500

Maletín Vaso Hexagonal (SAE)

Hexagonal Socket Case (SAE) • Coffret de Douilles Hexagonales (SAE)

33

SAE

Pcs

1/4"



260 x 167 x 62 mm

Vasos • Sockets • Douilles

5/32" • 3/16" • 7/32" • 1/4" • 9/32" • 5/16" • 11/32" • 3/8" • 7/16"
15/32" • 1/2" • 9/16"

Puntas de Atornillar • Screwdriver Bits • Embouts de Vissage



HX3 • HX4
HX5 • HX6



T10 • T15
T20 • T25



PH1 • PH2
PH3

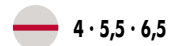

4 • 5,5 • 6,5

Llave de Carraca

Ratcheted Handle • Cliquet



72 dientes
72 teeth • 72 dents

Articulación Universal

Universal Joint • Cardan Universel



Destornillador Triple Cuadradillo

3 - Way Spinner Handle
Tournevis avec Triple Carré d'entraînement



Alargador Flexible

Flexible Extension
Rallonge Flexible



145 mm

Adaptador Espacios Confinados

Palm Driver • Adaptateur pour Accès Difficiles



Alargador

Extension • Rallonge



50 mm

Portapuntas Cuadradillo de Arrastre

Square Drive Bit Holder • Douille Porte-embouts à Carré d'entraînement

1/4" ▶ ◀ 1/4"

Part N°

€

500-005

102,47

1/4"

Juegos de Llaves de Vaso • Socket Sets • Jeux de Douilles

501

Maletín Vaso Bihexagonal
Bihexagonal Socket Case • Coffret de Douilles Bi-Hexagonales

17
Pcs

1/4"



260 x 167 x 62 mm

Vasos • Sockets • Douilles

4 • 4,5 • 5 • 5,5 • 6 • 7 • 8 • 9 • 10 • 11 • 12 • 13 • 14

Llave de Carraca
Ratched Handle • Cliquet

72 dientes
72 teeth • 72 dents



Articulación Universal
Universal Joint • Cardan Universel



Destornillador Triple Cuadrado
3 - Way Spinner Handle
Tournevis avec Triple Carré d'entraînement



Alargador
Extension • Rallonge



50 mm

Part N°

€

501-001

73,28

501

Maletín Vaso Bihexagonal
Bihexagonal Socket Case • Coffret de Douilles Bi-Hexagonales

34
Pcs

1/4"



260 x 167 x 62 mm

Vasos • Sockets • Douilles

4 • 4,5 • 5 • 5,5 • 6 • 7 • 8 • 9 • 10 • 11 • 12 • 13 • 14

Puntas de Atornillar • Screwdriver Bits • Embouts de Vissage

HX3 • HX4
HX5 • HX6

T10 • T15
T20 • T25

PH1 • PH2
PH3

4 • 5,5 • 6,5

Llave de Carraca
Ratched Handle • Cliquet

72 dientes
72 teeth • 72 dents



Articulación Universal
Universal Joint • Cardan Universel



Destornillador Triple Cuadrado
3 - Way Spinner Handle
Tournevis avec Triple Carré d'entraînement



Alargador Flexible
Flexible Extension
Rallonge Flexible



145 mm

Adaptador Espacios Confinados
Palm Driver • Adaptateur pour Accès Difficiles



Alargador
Extension • Rallonge



50 mm

Portapuntas Cuadrado de Arrastre
Square Drive Bit Holder • Douille Porte-embouts à Carré d'entraînement

1/4" ▶ ◀ 1/4"

Part N°

€

501-002

104,86

Juegos de Llaves de Vaso • Socket Sets • Jeux de Douilles

1/4"

500

Bandeja Combinable Vaso Hexagonal

Hexagonal Socket EVA Foam Tray • Panneau de Mousse Modulable Douilles Hexagonales

46
Pcs

1/4"



1/4 (375 x 140 x 30 mm)

Part N°	€
500-081	294,95

Vasos • Sockets • Douilles

4 • 4,5 • 5 • 5,5 • 6 • 7 • 8 • 9 • 10
11 • 12 • 13 • 14

Serie Larga • Deep • Série Longue

6 • 7 • 8 • 9 • 10 • 11 • 12 • 13 • 14

Vasos con Puntas • Socket Bits • Douilles-Embouts de Vissage

HX3 • HX4 • HX5
HX6 • HX7 • HX8

T10 • T15 • T20
T25 • T30 • T40

PH1 • PH2 • PH3

PZ1 • PZ2

Llave de Carraca • Ratched Handle • Cliquet

72 dientes
72 teeth • 72 dents

Destornillador • Spinner Handle • Tournevis

DOGHER

Alargadores • Extensions • Rallonges

100 mm
50 mm

Flexible • Flexible • Flexible

145 mm

Articulación Universal

Universal Joint • Cardan Universel



Mango Corredizo en T

Sliding "T" Handle • Manche en "T" à Glissement



500

Bandeja Combinable Vaso Hexagonal

Hexagonal Socket EVA Foam Tray • Panneau de Mousse Modulable Douilles Hexagonales

36
Pcs

1/4"



1/3 (375 x 188 x 30 mm)

Part N°	€
500-083	252,50

Vasos • Sockets • Douilles

5,5 • 6 • 7 • 8 • 9 • 10 • 11 • 12 • 13

Serie Larga • Deep • Série Longue

6 • 8 • 10 • 12 • 13

Vasos con Puntas • Socket Bits • Douilles-Embouts de Vissage

HX3 • HX4 • HX5
HX6 • HX7

4 • 5,5 • 6,5

PH1 • PH2 • PH3

PZ1 • PZ2 • PZ3

Llave de Carraca • Ratched Handle • Cliquet

72 dientes
72 teeth • 72 dents

Alargadores • Extensions • Rallonges

100 mm
50 mm

Destornillador • Spinner Handle • Tournevis

DOGHER

Adaptador Espacios Confinados

Palm Driver
Adaptateur pour Accès Difficiles

Articulación Universal

Universal Joint • Cardan Universel



Mango Corredizo en T

Sliding "T" Handle • Manche en "T" à Glissement



Juego de Llaves en Navaja • Folding Key Set • Jeu de Clés sur Monture

1,5 • 2 • 2,5 • 3 • 4 • 5 • 6 • 8

Ver Información Ampliada sobre Almacenaje y Bandejas Combinables en Páginas:

For Further Information About Storage and Eva Foam Trays:

Voir pour Plus d'information sur le Rangement et Panneaux de Mousse Modulables Pages:

10 • 11

1/4"

Juegos de Llaves de Vaso • Socket Sets • Jeux de Douilles

501

Bandeja Combinable Vaso Bihexagonal

Bihexagonal Socket EVA Foam Tray • Panneau de Mousse Modulable Douilles Bi-Hexagonales

46
Pcs

1/4"



1/4 (375 x 140 x 30 mm)

Part N°	€
501-081	294,95

Vasos • Sockets • Douilles

4 • 4,5 • 5 • 5,5 • 6 • 7 • 8 • 9 • 10
11 • 12 • 13 • 14

Serie Larga • Deep • Série Longue

6 • 7 • 8 • 9 • 10 • 11 • 12 • 13 • 14

Vasos con Puntas • Socket Bits • Douilles-Embouts de Vissage

HX3 • HX4 • HX5
HX6 • HX7 • HX8

T10 • T15 • T20
T25 • T30 • T40

PH1 • PH2 • PH3

PZ1 • PZ2

Llave de Carraca • Ratched Handle • Cliquet



72 dientes
72 teeth • 72 dents

Destornillador • Spinner Handle • Tournevis



Alargadores • Extensions • Rallonges



100 mm
50 mm

Flexible • Flexible • Flexible



145 mm

Articulación Universal

Universal Joint • Cardan Universel



Mango Corredizo en T

Sliding "T" Handle • Manche en "T" à Glissement



Ver Información Ampliada sobre Almacenaje y Bandejas Combinables en Páginas:

For Further Information About Storage and Eva Foam Trays:

Voir pour Plus d'information sur le Rangement et Panneaux de Mousse Modulables Pages:

10 • 11

3/8"

516

Hexagonal • Hexagonal • Hexagonale

3/8"



CrV



Ø mm	L mm	Part N°	€
6	28	516-06	4,08
7	28	516-07	4,08
8	28	516-08	4,13
9	28	516-09	4,13
10	28	516-10	4,15
11	28	516-11	4,20
12	28	516-12	4,23
13	28	516-13	4,23
14	28	516-14	4,60
15	28	516-15	5,08
16	30	516-16	5,08
17	30	516-17	5,08
18	30	516-18	5,80
19	30	516-19	5,98
20	30	516-20	6,73
21	30	516-21	6,78
22	30	516-22	7,00
24	30	516-24	7,77

515

Bihexagonal • Bihexagonal • Bi-Hexagonale

3/8"



CrV



Ø mm	L mm	Part N°	€
6	28	515-06	4,08
7	28	515-07	4,08
8	28	515-08	4,13
9	28	515-09	4,13
10	28	515-10	4,15
11	28	515-11	4,20
12	28	515-12	4,23
13	28	515-13	4,23
14	28	515-14	4,60
15	28	515-15	5,08
16	30	515-16	5,08
17	30	515-17	5,08
18	30	515-18	5,80
19	30	515-19	5,98
20	30	515-20	6,73
21	30	515-21	6,78
22	30	515-22	7,00
24	30	515-24	7,77

SAE

Ø	L mm	Part N°	€
1/4"	28	516-1/4	4,05
5/16"	28	516-5/16	4,17
3/8"	28	516-3/8	4,47
7/16"	28	516-7/16	4,50
1/2"	28	516-1/2	4,62
9/16"	28	516-9/16	5,04
5/8"	30	516-5/8	5,21
11/16"	30	516-11/16	5,67
3/4"	30	516-3/4	6,01
13/16"	30	516-13/16	6,17
7/8"	30	516-7/8	6,63

3/8"

517

Hexagonal Serie Larga

Hexagonal Long Series • Hexagonale Série Longue

3/8"



CrV



mm	L mm	Part N°	€
7	63	517-07	7,23
8	63	517-08	7,23
9	63	517-09	7,23
10	63	517-10	7,23
11	63	517-11	7,23
12	63	517-12	7,23
13	63	517-13	7,23
14	63	517-14	8,25
15	63	517-15	8,25
16	63	517-16	8,25
17	63	517-17	9,10
18	63	517-18	9,10
19	63	517-19	9,10

518

Torx • Torx • Torx

3/8"



CrV



	L mm	Part N°	€
E8	28	518-T08	5,38
E10	28	518-T10	5,63
E11	28	518-T11	5,88
E12	28	518-T12	5,98
E14	28	518-T14	6,23
E16	28	518-T16	6,70
E18	28	518-T18	7,18

526

Vaso para Bujías

Spark Plug Socket • Douille pour Bougies

3/8"



CrV



mm	L mm	Part N°	€
16	65	526-16	9,25
18	65	526-18	9,25
21	65	526-21	12,53

Llaves de Vaso con Punta • Socket Bits • Douilles - Embouts de Vissage

3/8"

519

Punta Recta • Slot • Plat

3/8"



S2



A mm	B mm	L mm	Part N°	€
5,5	1	48	519-055	6,63
6,5	1,2	48	519-065	6,63
8	1,2	48	519-080	6,63
10	1,6	48	519-100	7,20

520

Punta Phillips • Phillips • Phillips

3/8"



S2



Icon	L mm	Part N°	€
PH1	48	520-PH1	6,63
PH2	48	520-PH2	6,63
PH3	48	520-PH3	6,63

521

Punta Pozidriv • Pozidriv • Pozidriv

3/8"



S2



Icon	L mm	Part N°	€
PZ1	48	521-PZ1	6,77
PZ2	48	521-PZ2	6,77
PZ3	48	521-PZ3	6,77

523

Punta Torx • Torx • Torx

3/8"



S2



Icon	L mm	Part N°	€
T10	48	523-T10	8,35
T15	48	523-T15	8,35
T20	48	523-T20	8,69
T25	48	523-T25	8,69
T27	48	523-T27	8,69
T30	48	523-T30	8,69
T40	48	523-T40	8,69
T45	48	523-T45	9,04
T50	48	523-T50	9,04

Llaves de Vaso • Sockets • Douilles

3/8"

Llaves de Vaso con Punta • Socket Bits • Douilles - Embouts de Vissage

522

Punta Hexagonal • Hexagonal • Hexagonal

3/8"



S2



	L mm	Part N°	€
HX3	48	522-03	7,29
HX4	48	522-04	7,29
HX5	48	522-05	7,29
HX6	48	522-06	7,29
HX7	48	522-07	7,29
HX8	48	522-08	7,29
HX10	48	522-10	7,58

	L mm	Part N°	€
HX4	92	522-04X92	10,55
HX5	92	522-05X92	10,55
HX6	92	522-06X92	10,55
HX8	92	522-08X92	10,55
HX10	92	522-10X92	10,55

Accesorios para Llaves de Vaso • Accessories for Sockets • Accessoires pour Douilles

524

Alargador
Extension • Rallonge

3/8"

CrV



L mm	Part N°	€
75	524-002	9,98
125	524-003	11,25
150	524-004	12,23
250	524-005	14,70

524

Alargador Angular
Wobble Extension • Rallonge Angulaire

3/8"

CrV



L mm	Part N°	€
75	524-006	13,13

Accesorios para Llaves de Vaso • Accessories for Sockets • Accessoires pour Douilles

3/8"

524 Alargador con Bloqueo
Locking Extension Bar • Rallonge à Verrouillage

3/8"

CrV



L mm	Part N°	€
150	524-007	23,88

524 Articulación Universal
Universal Joint • Cardan Universel

3/8"

CrV



Part N°	€
524-009	21,93

524 Adaptador Ampliador
Increasing Adaptor • Augmentateur

3/8"

1/2"

CrV



□	□	Part N°	€
3/8"	1/2"	524-011	9,75

524 Adaptador Reductor
Reducing Adaptor • Réducteur

3/8"

1/4"

CrV



□	□	Part N°	€
3/8"	1/4"	524-012	9,18

524 Adaptador Apriete Manual Espacios Confinados
Multi-Function Palm Driver
Adaptateur Serrage Manuel pour Accès Difficiles

3/8"

1/2"

CrV



□	Part N°	€
3/8"	524-013	9,98

524 Mango Corredizo en "T"
Sliding "T" Handle • Manche en "T" à Glissement

3/8"

CrV



□	L mm	Part N°	€
3/8"	150	524-016	12,33
3/8"	200	524-014	13,88

3/8"

Accesorios para Llaves de Vaso • Accessories for Sockets • Accessoires pour Douilles

524

Repuesto de Barra para Mango Corredizo en "T"
Spare Bar for Sliding "T" Handle • Rechange pour Manche en "T" à Glissement

CrV



L mm	Part N°	€
200	524-015	9,44

524

Portapuntas con Cuadradillo de Arrastre
Square Drive Bit Holder • Douille Porte-Embouts à Jonc de Retenue

3/8"

5/16"

CrV



		Part N°	€
3/8"	5/16"	524-017	7,25

524

Adaptador Mango Hexagonal para Vasos
Hexagonal Shank Socket Adaptor • Adaptateur Porte-Douille

3/8"

1/4"

CrV



		L mm	Part N°	€
3/8"	1/4"	65	524-019	11,95

524

Adaptador Espacios Confinados
Rolling Joint • Adaptateur pour Accès Difficiles

3/8"

CrV



	Part N°	€
3/8"	524-020	10,25

524

Mango Corredizo en "T" con Tope Lateral
Sliding "T" Handle with Side Stopper • Manche en T à Glissement avec Butée de Côté

3/8"

CrV



	L mm	Part N°	€
3/8"	200	524-025	15,30

Llaves de Carraca • Ratchet Handles • Cliquets

3/8"

525

Llave de Carraca
Ratchet Handle • Cliquet

3/8"

72^{5°}

CrV



TH	L mm	Part N°	€
72 TH	200	525-001	35,49

525

Llave de Carraca Corta
Stubby Ratchet Handle • Cliquet Court

3/8"

72^{5°}

CrV



TH	L mm	Part N°	€
72 TH	141	525-002	23,65

525

Llave de Carraca Extensible
Extendable Ratchet Handle • Cliquet Extensible

3/8"

72^{5°}

CrV



TH	L mm	Part N°	€
72 TH	220~323	525-003	42,50

525

Llave de Carraca Cambio Rápido
One Hand Switch Ratchet Handle • Cliquet Changement Rapide

3/8"

60^{6°}

CrV



TH	L mm	Part N°	€
60 TH	200	525-004	49,68

3/8"

Juegos de Llaves de Vaso • Socket Sets • Jeux de Douilles

516

Hexagonal • Hexagonal • Hexagonale

9

Pcs

3/8"



10 · 11 · 12 · 13 · 14 · 15 · 16 · 17 · 18

Part N°	€
516-051	43,10

516

Hexagonal y Llave de Carraca
Hexagonal and Ratchet Handle
Hexagonale et Cliquet

12

Pcs

3/8"



8 · 9 · 10 · 11 · 12 · 13 · 14 · 15 · 16 · 17 · 18

72 dientes • 72 teeth • 72 dents

Part N°	€
516-061	87,11

516

Hexagonal, Llave de Carraca y Alargador
Hexagonal, Ratchet Handle and Extension
Hexagonale, Cliquet et Rallonge

20

Pcs

3/8"



6 · 7 · 8 · 9 · 10 · 11 · 12 · 13 · 14 · 15 · 16 · 17
18 · 19 · 20 · 21 · 22 · 24

72 dientes • 72 teeth • 72 dents

75 mm

Part N°	€
516-071	140,85

515

Bihexagonal • Bihexagonal • Bi-Hexagonale

9

Pcs

3/8"



10 · 11 · 12 · 13 · 14 · 15 · 16 · 17 · 18

Part N°	€
515-051	43,10

Juegos de Llaves de Vaso • Socket Sets • Jeux de Douilles

3/8"

515

Bihexagonal y Llave de Carraca
Bihexagonal and Ratchet Handle
Bi-Hexagonale et Cliquet

10
Pcs

3/8"



10 · 11 · 12 · 13 · 14 · 15 · 16 · 17 · 18

72 dientes • 72 teeth • 72 dents

Part N°

€

515-061

78,86

515

Bihexagonal, Llave de Carraca y Alargador
Bihexagonal, Ratchet Handle and Extension
Bi-Hexagonale, Cliquet et Rallonge

20
Pcs

3/8"



6 · 7 · 8 · 9 · 10 · 11 · 12 · 13 · 14 · 15 · 16 · 17
18 · 19 · 20 · 21 · 22 · 24

72 dientes • 72 teeth • 72 dents

75 mm

Part N°

€

515-071

140,85

517

Hexagonal Serie Larga
Hexagonal Long Series
Hexagonale Série Longue

7
Pcs

3/8"



10 · 12 · 13 · 14 · 15 · 17 · 19

Part N°

€

517-051

57,05

523

Punta Torx • Torx • Torx

9
Pcs

3/8"



T10 · T15 · T20 · T25 · T27 · T30 · T40 · T45 · T50

Part N°

€

523-051

78,91

3/8"

Juegos de Llaves de Vaso • Socket Sets • Jeux de Douilles

516

Maletín Vaso Hexagonal

Hexagonal Socket Case • Coffret de Douilles Hexagonales

16

Pcs

3/8"



260 x 167 x 62 mm

Vasos • Sockets • Douilles



8 • 9 • 10 • 11 • 12 • 13 • 14 • 15 • 16 • 17 • 18 • 19

Llave de Carraca

Ratched Handle • Cliquet



72 dientes
72 teeth • 72 dents

Adaptador Espacios Confinados

Palm Driver • Adaptateur pour Accès Difficiles



Articulación Universal

Universal Joint • Cardan Universel



Alargador

Extension • Rallonge



75 mm

Part N°

€

516-001

93,81

516

Maletín Vaso Hexagonal

Hexagonal Socket Case • Coffret de Douilles Hexagonales

17

Pcs

3/8"



260 x 167 x 62 mm

Vasos • Sockets • Douilles



8 • 9 • 10 • 11 • 12 • 13 • 14 • 15 • 16 • 17 • 18 • 19

Llave de Carraca

Ratched Handle • Cliquet



72 dientes
72 teeth • 72 dents

Alargador

Extension • Rallonge



75 mm

Articulación Universal

Universal Joint • Cardan Universel



Mango Corredizo en "T"

Sliding "T" Handle • Manche en "T" à Glissement



Adaptador Espacios Confinados

Palm Driver

Adaptateur pour Accès Difficiles

Part N°

€

516-002

103,52

516

Maletín Vaso Hexagonal

Hexagonal Socket Case • Coffret de Douilles Hexagonales

34

Pcs

3/8"



260 x 167 x 62 mm

Vasos • Sockets • Douilles

6 • 8 • 10 • 11 • 12 • 13 • 14 • 15 • 16 • 17 • 18 • 19

1/4" • Vasos con Puntas • Socket Bits • Douilles-Embouts de Vissage

HX3 • HX4 • HX5 • HX6

T10 • T15 • T20 • T25 • T27 • T30 • T40

PH0 • PH1 • PH2 • PH3

Llave de Carraca

Ratched Handle • Cliquet

72 dientes
72 teeth • 72 dents

Destornillador • Spinner Handle • Tournevis



Adaptador

Adapter • Adaptateur

1/4" ▶ ◀ 3/8"

Articulación Universal

Universal Joint • Cardan Universel



Alargadores • Extensions • Rallonges

150 mm
75 mm

Mango Corredizo en "T"

Sliding "T" Handle • Manche en "T" à Glissement



Part N°

€

516-003

174,41

516

Bandeja Combinable Vaso Hexagonal

Hexagonal Socket EVA Foam Tray • Panneau de Mousse Modulable Douilles Hexagonales

22

Pcs

3/8"



1/4 (375 x 140 x 30 mm)

Vasos • Sockets • Douilles

6 • 7 • 8 • 9 • 10 • 11 • 12 • 13 • 14 • 15 • 16 • 17 • 18 • 19 • 20 • 21 • 22

Llave de Carraca • Ratched Handle • Cliquet

72 dientes
72 teeth • 72 dents

Articulación Universal
Universal Joint • Cardan Universel



Alargadores • Extensions • Rallonges

100 mm
50 mm

Mango Corredizo en T

Sliding "T" Handle • Manche en "T" à Glissement



Part N°

€

516-080

186,59

Ver Información Ampliada sobre Almacenaje y Bandejas Combinables en Páginas:

For Further Information About Storage and Eva Foam Trays:

Voir pour Plus d'information sur le Rangement et Panneaux de Mousse Modulables Pages:

10 • 11

1/2"

531

Hexagonal • Hexagonal • Hexagonale

1/2"



CrV



Ø mm	L mm	Part N°	€
8	38	531-08	4,71
9	38	531-09	4,71
10	38	531-10	4,71
11	38	531-11	4,83
12	38	531-12	5,28
13	38	531-13	5,43
14	38	531-14	5,69
15	38	531-15	5,88
16	38	531-16	6,05
17	38	531-17	6,23
18	38	531-18	6,28
19	38	531-19	6,46
20	38	531-20	6,75
21	38	531-21	6,81
22	40	531-22	7,04
23	40	531-23	7,53
24	40	531-24	8,06
25	40	531-25	8,28
26	40	531-26	8,47
27	42	531-27	8,65
28	42	531-28	9,36
29	42	531-29	9,54
30	42	531-30	9,66
32	45	531-32	10,08
34	46	531-34	13,99
35	46	531-35	15,80
36	46	531-36	17,98

SAE

Ø	L mm	Part N°	€
5/16"	38	531-5/16	4,75
11/32"	38	531-11/32	4,78
3/8"	38	531-3/8	4,78
7/16"	38	531-7/16	4,92
15/32"	38	531-15/32	5,13
1/2"	38	531-1/2	5,28
9/16"	38	531-9/16	5,79
19/32"	38	531-19/32	6,02
5/8"	38	531-5/8	6,13
11/16"	38	531-11/16	6,36
23/32"	38	531-23/32	6,50
3/4"	38	531-3/4	6,64
13/16"	40	531-13/16	6,88
7/8"	40	531-7/8	7,16
15/16"	40	531-15/16	7,95
1.1/16"	42	531-1.1/16	8,54
1.3/16"	42	531-1.3/16	9,56
1.1/4"	45	531-1.1/4	9,90

Llaves de Vaso con Punta • Socket Bits • Douilles - Embouts de Vissage

1/2"

530

Bihexagonal • Bihexagonal • Bi-Hexagonale



Ø mm	L mm	Part N°	€
8	38	530-08	4,71
9	38	530-09	4,71
10	38	530-10	4,71
11	38	530-11	4,83
12	38	530-12	5,28
13	38	530-13	5,43
14	38	530-14	5,69
15	38	530-15	5,88
16	38	530-16	6,05
17	38	530-17	6,23
18	38	530-18	6,28
19	38	530-19	6,46
20	38	530-20	6,75
21	38	530-21	6,81
22	40	530-22	7,04
23	40	530-23	7,53
24	40	530-24	8,06
25	40	530-25	8,28
26	42	530-26	8,47
27	42	530-27	8,65
28	42	530-28	9,36
29	42	530-29	9,54
30	45	530-30	9,66
32	45	530-32	10,08

532

Hexagonal Serie Larga

Hexagonal Long Series • Hexagonale Série Longue



Ø mm	L mm	Part N°	€
10	77	532-10	13,52
11	77	532-11	13,52
12	77	532-12	13,52
13	77	532-13	13,78
14	77	532-14	13,78
15	77	532-15	13,78
16	77	532-16	13,78
17	77	532-17	13,78
18	77	532-18	13,78
19	77	532-19	13,78
20	77	532-20	14,07
21	77	532-21	14,20
22	77	532-22	18,18
23	77	532-23	18,18
24	77	532-24	18,24
25	77	532-25	18,44
26	77	532-26	18,44
27	77	532-27	18,77
28	77	532-28	19,22
29	77	532-29	20,07
30	77	532-30	20,93
32	77	532-32	26,22

Llaves de Vaso • Sockets • Douilles

1/2"

533

Torx • Torx • Torx

1/2"



CrV



	L mm	Part N°	€
E10	38	533-T10	6,78
E11	38	533-T11	6,78
E12	38	533-T12	6,78
E14	38	533-T14	6,78
E16	38	533-T16	6,78
E18	38	533-T18	7,28
E20	38	533-T20	7,68
E22	38	533-T22	8,25
E24	38	533-T24	8,78

545

Vaso para Bujías

Spark Plug Socket • Douille pour Bougies

1/2"



CrV



	mm	L mm	Part N°	€
16	65		545-16	7,53
21	65		545-21	9,00

Llaves de Vaso con Punta • Socket Bits • Douilles - Embouts de Vissage

539

Punta Phillips • Phillips • Phillips

1/2"



S2



	L mm	Part N°	€
PH1	55	539-PH1	9,48
PH2	55	539-PH2	9,48
PH3	55	539-PH3	11,16

540

Punta Pozidriv • Pozidriv • Pozidriv

1/2"



S2



	L mm	Part N°	€
PZ1	55	540-PZ1	10,30
PZ2	55	540-PZ2	10,30
PZ3	55	540-PZ3	12,22

Llaves de Vaso con Punta • Socket Bits • Douilles - Embouts de Vissage

1/2"

534

Punta Hexagonal • Hexagonal • Hexagonal



	L mm	Part N°	€
HX4	55	534-04	8,25
HX5	55	534-05	8,25
HX6	55	534-06	8,25
HX7	55	534-07	8,38
HX8	55	534-08	8,38
HX10	55	534-10	8,38
HX12	55	534-12	9,65
HX14	55	534-14	9,65
HX17	55	534-17	12,45
HX19	55	534-19	13,18

538

Punta Hexagonal Serie Larga
Hexagonal Long Series • Hexagonal Série Longue

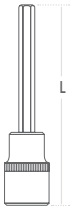

	L mm	Part N°	€
HX5	100	538-05X100	12,20
HX5	140	538-05X140	15,82
HX6	100	538-06X100	12,20
HX6	200	538-06X200	15,82
HX7	100	538-07X100	12,54
HX8	100	538-08X100	12,54
HX10	140	538-10X140	17,20
HX12	100	538-12X100	14,83

537

Punta Torx Seguridad
Torx Tamper • Torx Sécurité



	L mm	Part N°	€
TS20	55	537-TS20	10,98
TS25	55	537-TS25	10,98
TS27	55	537-TS27	10,98
TS30	55	537-TS30	10,98
TS40	55	537-TS40	11,19
TS45	55	537-TS45	11,19
TS50	55	537-TS50	11,19
TS55	55	537-TS55	14,20
TS60	55	537-TS60	14,62

1/2"

Llaves de Vaso con Punta • Socket Bits • Douilles - Embouts de Vissage

535

Punta XZN • XZN • XZN

1/2"



S2



	L mm	Part N°	€
XZN5	55	535-05	11,66
XZN6	55	535-06	12,14
XZN8	55	535-08	12,14
XZN10	55	535-10	12,34
XZN12	55	535-12	13,32
XZN14	55	535-14	13,32
XZN16	55	535-16	15,89

541

Punta XZN Serie Larga

XZN Long Series • XZN Série Longue

1/2"



S2

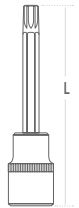

	L mm	Part N°	€
XZN8	100	541-08X100	13,93
XZN10	100	541-10X100	15,04
XZN12	100	541-12X100	17,05

536

Punta Torx • Torx • Torx

1/2"



S2



	L mm	Part N°	€
T20	55	536-T20	10,46
T25	55	536-T25	10,46
T27	55	536-T27	10,46
T30	55	536-T30	10,46
T40	55	536-T40	10,66
T45	55	536-T45	10,66
T50	55	536-T50	10,66
T55	55	536-T55	13,52
T60	55	536-T60	13,92

542

Punta Torx Serie Larga

Torx Long Series • Torx Série Longue

1/2"



S2



	L mm	Part N°	€
T40	120	542-T40X120	13,15
T45	120	542-T45X120	13,15
T50	120	542-T50X120	13,15
T55	120	542-T55X120	21,62
T70	140	542-T70X140	22,85

Accesorios para Llaves de Vaso • Accessories for Sockets • Accessoires pour Douilles

1/2"

543 Alargador • Extension • Rallonge

1/2"

CrV



L mm	Part N°	€
75	543-002	9,18
125	543-003	9,13
250	543-005	13,88

543 Alargador Angular
Wobble Extension • Rallonge Angulaire

1/2"

CrV



L mm	Part N°	€
75	543-006	10,95
125	543-007	11,49
250	543-008	17,53

543 Articulación Universal
Universal Joint • Cardan Universel

1/2"

CrV



Part N°	€
543-009	23,25

543 Alargador con Bloqueo
Locking Extension Bar • Rallonge à Verrouillage

1/2"

CrV

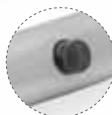

L mm	Part N°	€
125	543-010	16,68

543 Adaptador Ampliador
Increasing Adaptor • Augmentateur

1/2"

3/4"

CrV



□	□	Part N°	€
1/2"	3/4"	543-011	14,85

543 Adaptador Reductor
Reducing Adaptor • Réducteur

1/2"

CrV



□	□	Part N°	€
1/2"	3/8"	543-012	12,58
1/2"	1/4"	543-019	7,78

1/2"

Accesorios para Llaves de Vaso • Accessories for Sockets • Accessoires pour Douilles

543

Adaptador Apriete Manual Espacios Confinados
Multi-Function Palm Driver • Adaptateur Serrage Manuel pour Accès Difficiles

1/2"

1/2"

CrV



	Part N°	€
1/2"	543-013	11,13

543

Mango Corredizo en "T"
Sliding "T" Handle • Manche en "T" à Glissement

1/2"

CrV



	L mm	Part N°	€
1/2"	250	543-014	17,90

543

Repuesto de Barra para Mango Corredizo en "T"
Spare Bar for Sliding "T" Handle • Rechange pour Manche en "T" à Glissement

CrV



L mm	Part N°	€
250	543-015	12,80

543

Mango Articulado
Swivel Handle • Manche Articulé

1/2"

CrV



L mm	Part N°	€
150	543-016	30,53
375	543-017	34,45

Accesorios para Llaves de Vaso • Accessories for Sockets • Accessoires pour Douilles

1/2"

543

Portapuntas con Cuadradillo de Arrastre

Square Drive Bit Holders • Douille Porte-Embouts à Jonc de Retenue

1/2"



CrV



□	○	Part N°	€
1/2"	5/16"	543-018	7,88
1/2"	10 mm	543-027	7,88

543

Adaptador Espacios Confinados

Rolling Joint • Adaptateur pour Accès Difficiles

1/2"

CrV



□	Part N°	€
1/2"	543-020	14,18

543

Mango Corredizo en "T" con Tope Lateral

Sliding "T" Handle with Side Stopper • Manche en T à Glissement avec Butée de Côté

1/2"

CrV



□	L mm	Part N°	€
1/2"	250	543-025	17,90

543

Alargador Flexible

Flexible Extension • Rallonge Flexible

1/2"

CrV



L mm	Part N°	€
200	543-026	12,80

1/2"

Llaves de Carraca • Ratchet Handles • Cliquets

544

Llave de Carraca • Ratchet Handle • Cliquet

1/2"

72^{5°}

CrV



TH	L mm	Part N°	€
72 TH	250	544-001	39,86

544

Llave de Carraca Corta • Stubby Ratchet Handle • Cliquet Court

1/2"

72^{5°}

CrV



TH	L mm	Part N°	€
72 TH	170	544-002	26,55

544

Llave de Carraca Extensible • Extendable Ratchet Handle • Cliquet Extensible

1/2"

72^{5°}

CrV



TH	L mm	Part N°	€
72 TH	275-445	544-003	49,56

544

Llave de Carraca Cambio Rápido • One Hand Switch Ratchet Handle • Cliquet Changement Rapide

1/2"

60^{6°}

CrV



TH	L mm	Part N°	€
60 TH	245	544-004	52,45

Juegos de Llaves de Vaso • Socket Sets • Jeux de Douilles

1/2"

531

Hexagonal • Hexagonal • Hexagonale

10
Pcs

1/2"



9 · 10 · 11 · 12 · 13 · 14 · 15 · 17 · 18 · 19

Part N°	€
531-051	56,27

531

Hexagonal, Llave de Carraca y Alargador
Hexagonal, Ratchet Handle and Extension
Hexagonale, Cliquet et Rallonge

13
Pcs

1/2"



8 · 9 · 10 · 11 · 12 · 13 · 14 · 15 · 17 · 19 · 21



72 dientes • 72 teeth • 72 dents

125 mm

Part N°	€
531-061	110,71

531

Hexagonal, Llave de Carraca y Alargador
Hexagonal, Ratchet Handle and Extension
Hexagonale, Cliquet et Rallonge

17
Pcs

1/2"



8 · 10 · 11 · 12 · 13 · 14 · 15 · 17 · 19 · 20 · 22
24 · 27 · 30 · 32



72 dientes • 72 teeth • 72 dents

250 mm

Part N°	€
531-071	154,75

531

Hexagonal, Llave de Carraca y Alargador
Hexagonal, Ratchet Handle and Extension
Hexagonale, Cliquet et Rallonge

17
Pcs

1/2"



10 · 11 · 12 · 13 · 14 · 15 · 16 · 17 · 18 · 19
21 · 22 · 24 · 27 · 30 · 32



72 dientes • 72 teeth • 72 dents

Part N°	€
531-072	148,55

1/2"

Juegos de Llaves de Vaso • Socket Sets • Jeux de Douilles

530

Bihexagonal • Bihexagonal • Bi-Hexagonale

10
Pcs

1/2"



9 · 10 · 11 · 12 · 13 · 14 · 15 · 17 · 18 · 19

Part N°	€
530-051	56,27

530

Bihexagonal, Llave de Carraca y Alargador
Bihexagonal, Ratchet Handle and Extension
Bi-Hexagonale, Cliquet et Rallonge

13
Pcs

1/2"



8 · 9 · 10 · 11 · 12 · 13 · 14 · 15 · 17 · 19 · 21



72 dientes • 72 teeth • 72 dents

125 mm

Part N°	€
530-061	110,71

530

Bihexagonal, Llave de Carraca y Alargador
Bihexagonal, Ratchet Handle and Extension
Bi-Hexagonale, Cliquet et Rallonge

17
Pcs

1/2"



8 · 10 · 11 · 12 · 13 · 14 · 15 · 17 · 19 · 20 · 22
24 · 27 · 30 · 32

72 dientes • 72 teeth • 72 dents

250 mm

Part N°	€
530-071	154,75

530

Bihexagonal y Llave de Carraca
Bihexagonal and Ratchet Handle
Bi-Hexagonale et Cliquet

17
Pcs

1/2"



10 · 11 · 12 · 13 · 14 · 15 · 16 · 17 · 18 · 19
21 · 22 · 24 · 27 · 30 · 32

72 dientes • 72 teeth • 72 dents

Part N°	€
530-072	148,55

Juegos de Llaves de Vaso • Socket Sets • Jeux de Douilles

1/2"

530

Bihexagonal y Llave de Carraca
Bihexagonal and Ratchet Handle
Bi-Hexagonale et Cliquet

11
Pcs

1/2"



9 · 10 · 11 · 12 · 13 · 14 · 15 · 17 · 18 · 19

72 dientes • 72 teeth • 72 dents

Part N°	€
530-062	96,35

532

Hexagonal Serie Larga
Hexagonal Long Series
Hexagonale Série Longue

6
Pcs

1/2"



13 · 14 · 15 · 16 · 17 · 18

Part N°	€
532-051	83,47

534

Punta Hexagonal
Hexagonal • Hexagonale

9
Pcs

1/2"



4 · 5 · 6 · 7 · 8 · 10 · 12 · 14 · 17

Part N°	€
534-051	82,41

539

Punta Phillips y Punta XZN
Phillips and XZN • Phillips et XZN

7
Pcs

1/2"



PH2 · PH3

5 · 6 · 8 · 10 · 12

Part N°	€
539-051	83,02

1/2"

Juegos de Llaves de Vaso • Socket Sets • Jeux de Douilles

536

Punta Torx • Torx • Torx

9

Pcs

1/2"



★ T20 • T25 • T27 • T30 • T40 • T45 • T50 • T55 • T60

Part N°	€
536-051	102,04

537

Punta Torx Seguridad

Torx Tamper • Torx Sécurité

9

Pcs

1/2"



★ TS20 • TS25 • TS27 • TS30 • TS40 • TS45 • TS50
TS55 • TS60

Part N°	€
537-051	107,10

531

Maletín Vaso Hexagonal

Hexagonal Socket Case • Coffret de Douilles Hexagonales

14

Pcs

1/2"



260 x 167 x 62 mm

Vasos • Sockets • Douilles



10 • 11 • 12 • 13 • 14 • 15 • 16 • 17 • 18 • 19 • 21 • 22

Llave de Carraca

Ratched Handle • Cliquet



72 dientes

72 teeth • 72 dents

Articulación Universal

Universal Joint • Cardan Universel



Part N°	€
531-001	93,65

531

Maletín Vaso Hexagonal

Hexagonal Socket Case • Coffret de Douilles Hexagonales

19

Pcs

1/2"



385 x 280 x 87 mm

Vasos • Sockets • Douilles



10 • 11 • 12 • 13 • 14 • 15 • 16 • 17 • 18 • 19 • 20 • 21 • 22

Llave de Carraca

Ratched Handle • Cliquet



72 dientes

72 teeth • 72 dents

Articulación Universal

Universal Joint • Cardan Universel



Adaptador Triple Función

3-Way Adapter
Adaptateur avec Triple Fonction



3/8" • 1/2"

Alargadores • Extensions • Rallonges



250 mm
125 mm



Adaptador Espacios Confinados

Palm Driver
Adaptateur pour Accès Difficiles

Part N°	€
531-002	131,07

1/2"

Juegos de Llaves de Vaso • Socket Sets • Jeux de Douilles

531

Maletín Vaso Hexagonal
Hexagonal Socket Case • Coffret de Douilles Hexagonales

41
Pcs

1/2"



385 x 280 x 87 mm

Vasos • Sockets • Douilles

8 • 9 • 10 • 11 • 12 • 13 • 14 • 15 • 16 • 17 • 18 • 19 • 21 • 22 • 24 • 27 • 30 • 32

5/16" • Puntas de Atornillar • Screwdriver Bits • Embouts de Vissage

HX7 • HX8 • HX10 • HX12 T40 • T45 • T50 • T55 • T60

PZ3 • PZ4 PH3 • PH4 8 • 10 • 12

Llave de Carraca
Ratched Handle • Cliquet

72 dientes
72 teeth • 72 dents



Articulación Universal
Universal Joint • Cardan Universel



Portapuntas Cuadrado de Arrastre
Square Drive Bit Holder
Douille Porte-embouts à Carré d'entraînement

5/16" ▶ ◀ 1/2"



Adaptador Espacios Confinados
Palm Driver
Adaptateur pour Accès Difficiles

Adaptador Triple Función
3-Way Adapter • Adaptateur avec Triple Fonction

3/8" ▶ ◀ 1/2"



Alargadores • Extensions • Rallonges

250 mm
125 mm

Part N°

€

531-003

194,50

531

Maletín Vaso Hexagonal (SAE)
Hexagonal Socket Case (SAE) • Coffret de Douilles Hexagonales (SAE)

41
Pcs

1/2"

SAE



385 x 280 x 87 mm

Vasos • Sockets • Douilles

5/16" • 11/32" • 3/8" • 7/16" • 15/32" • 1/2" • 9/16" • 19/32" • 5/8" • 11/16" • 23/32" • 3/4" • 13/16" • 7/8" • 15/16" • 1.1/16" • 1.3/16" • 1.1/4"

5/16" • Puntas de Atornillar • Screwdriver Bits • Embouts de Vissage

HX7 • HX8 • HX10 • HX12 T40 • T45 • T50 • T55 • T60

PZ3 • PZ4 PH3 • PH4 8 • 10 • 12

Llave de Carraca
Ratched Handle • Cliquet

72 dientes
72 teeth • 72 dents



Articulación Universal
Universal Joint • Cardan Universel



Portapuntas Cuadrado de Arrastre
Square Drive Bit Holder
Douille Porte-embouts à Carré d'entraînement

5/16" ▶ ◀ 1/2"



Adaptador Espacios Confinados
Palm Driver
Adaptateur pour Accès Difficiles

Adaptador Triple Función
3-Way Adapter • Adaptateur avec Triple Fonction

3/8" ▶ ◀ 1/2"



Alargadores • Extensions • Rallonges

250 mm
125 mm

Part N°

€

531-004

193,34

Juegos de Llaves de Vaso • Socket Sets • Jeux de Douilles

1/2"

530

Maletín Vaso Bihexagonal

Bihexagonal Socket Case • Coffret de Douilles Bi-Hexagonales

14
Pcs

1/2"



260 x 197 x 62 mm

Vasos • Sockets • Douilles



10 • 11 • 12 • 13 • 14 • 15 • 16 • 17 • 18 • 19 • 21 • 22

Llave de Carraca

Ratched Handle • Cliquet



72 dientes

72 teeth • 72 dents

Articulación Universal

Universal Joint • Cardan Universel



Part N°

€

530-001

93,65

530

Maletín Vaso Bihexagonal

Bihexagonal Socket Case • Coffret de Douilles Bi-Hexagonales

41
Pcs

1/2"



385 x 280 x 87 mm

Vasos • Sockets • Douilles



8 • 9 • 10 • 11 • 12 • 13 • 14 • 15 • 16 • 17 • 18 • 19 • 21 • 22 • 24 • 27 • 30 • 32

5/16" • Puntas de Atornillar • Screwdriver Bits • Embouts de Vissage



HX7 • HX8 • HX10 • HX12



T40 • T45 • T50 • T55 • T60



PZ3 • PZ4



PH3 • PH4



8 • 10 • 12

Llave de Carraca

Ratched Handle • Cliquet



72 dientes

72 teeth • 72 dents

Articulación Universal

Universal Joint • Cardan Universel



Portapuntas Cuadrado de Arrastre

Square Drive Bit Holder

Douille Porte-embouts à Carré d'entraînement

5/16" ▶ ◀ 1/2"



Adaptador Espacios Confinados

Palm Driver

Adaptateur pour Accès Difficiles

Adaptador Triple Función

3-Way Adapter • Adaptateur avec Triple Fonction

3/8" ▶ ◀ 1/2"

Alargadores • Extensions • Rallonges



250 mm

125 mm

Part N°

€

530-003

194,50

1/2"

Juegos de Llaves de Vaso • Socket Sets • Jeux de Douilles

531

Bandeja Combinable Vaso Hexagonal

Hexagonal Socket EVA Foam Tray • Panneau de Mousse Modulable Douilles Hexagonales

27
Pcs

1/2"



1/3 (375 x 188 X 30 mm)

Part N°	€
531-080	252,33

Vasos • Sockets • Douilles

8 • 9 • 10 • 11 • 12 • 13 • 14 • 15 • 16 • 17 • 18 • 19 • 20 • 21 • 22 • 23 • 24 • 27 • 30 • 32

Llave de Carraca • Ratched Handle • Cliquet

72 dientes
72 teeth • 72 dents



Alargadores • Extensions • Rallonges

250 mm
125 mm



Articulación Universal

Universal Joint • Cardan Universel



Adaptador Triple Función

3-Way Adapter • Adaptateur avec Triple Fonction

• 3/8" • 1/2"

Vasos para Bujías • Spark Plug Sockets • Douilles pour Bougies

16 • 21

530

Bandeja Combinable Vaso Bihexagonal

Bi-hexagonal Socket EVA Foam Tray • Panneau de Mousse Modulable Douilles Bi-Hexagonales

27
Pcs

1/2"



1/3 (375 x 188 X 30 mm)

Part N°	€
530-080	252,33

Vasos • Sockets • Douilles

8 • 9 • 10 • 11 • 12 • 13 • 14 • 15 • 16 • 17 • 18 • 19 • 20 • 21 • 22 • 23 • 24 • 27 • 30 • 32

Llave de Carraca • Ratched Handle • Cliquet

72 dientes
72 teeth • 72 dents



Alargadores • Extensions • Rallonges

250 mm
125 mm



Articulación Universal

Universal Joint • Cardan Universel



Adaptador Triple Función

3-Way Adapter • Adaptateur avec Triple Fonction

• 3/8" • 1/2"

Vasos para Bujías • Spark Plug Sockets • Douilles pour Bougies

16 • 21

534

Bandeja Combinable Vaso con Punta

Socket Bits EVA Foam Tray
Panneau de Mousse Modulable Douilles - Embout de Vissage

26
Pcs

1/2"



1/4 (375 x 140 x 30 mm)

- 4 • 5 • 6 • 7 • 8 • 10 • 12 • 14 • 17 • 19
- T20 • T25 • T27 • T30 • T40 • T45 • T50 • T55 • T60
- 5 • 6 • 8 • 10 • 12 • 14 • 16

Part N°	€
534-080	293,25

538

Bandeja Combinable Vaso con Punta

Socket Bits EVA Foam Tray
Panneau de Mousse Modulable Douilles - Embout de Vissage

12
Pcs

1/2"



1/4 (375 x 140 x 30 mm)

- 5 • 6 • 7 • 8 • 12 100mm • 5 • 10 140mm
- T40 • T55 120mm
- 8 • 10 • 12 100mm

Part N°	€
538-080	184,49

Juegos de Llaves de Vaso Mixtos • Mixed Socket Sets • Jeux de Douilles Mixtes

1/4" 1/2"

500

Maletín Vaso Hexagonal
Hexagonal Socket Case • Coffret de Douilles Hexagonales

76
Pcs



440 x 305 x 92 mm

Part N°	€
500-025	276,57

1/4"

Vasos • Sockets • Douilles

4 • 4,5 • 5 • 5,5 • 6 • 7 • 8 • 9 • 10 • 11 • 13

Puntas de Atornillar • Screwdriver Bits • Embouts de Vissage

HX2 • HX3 • HX4 • HX5 • HX6 • HX7 T10 • T15 • T20 • T25 • T27 • T30

3 • 4,5 • 5,5 • 6,5 PH0 • PH1 • PH2 • PH3 PZ2 • PZ3

Llave de Carraca
Ratched Handle • Cliquet

72 dientes
72 teeth • 72 dents



Articulación Universal
Universal Joint • Cardan Universel



Destornillador Triple Cuadradillo
3 - Way Spinner Handle
Tournevis avec Triple Carré d'entraînement



Portapuntas Cuadradillo de Arrastre
Square Drive Bit Holder
Douille Porte-embouts à Carré d'entraînement

1/4" 1/4"

Adaptador Espacios Confinados
Palm Driver
Adaptateur pour Accès Difficiles



Alargadores • Extensions • Rallonges

100 mm
50 mm



1/2"

Vasos • Sockets • Douilles

10 • 11 • 12 • 13 • 14 • 15 • 16 • 17 • 19 • 21 • 24 • 27 • 30 • 32

5/16" • Puntas de Atornillar • Screwdriver Bits • Embouts de Vissage

HX8 • HX10 • HX12 T40 • T45 • T50 • T55 • T60

PZ3 • PZ4 PH3 • PH4 8 • 10 • 12

Llave de Carraca
Ratched Handle • Cliquet

72 dientes
72 teeth • 72 dents



Articulación Universal
Universal Joint • Cardan Universel



Adaptador Triple Función
3-Way Adapter • Adaptateur avec Triple Fonction

3/8" 1/2"

Portapuntas Cuadradillo de Arrastre
Square Drive Bit Holder
Douille Porte-embouts à carré d'entraînement

5/16" 1/2"

Adaptador Espacios Confinados
Palm Driver
Adaptateur pour Accès Difficiles



Alargadores • Extensions • Rallonges

250 mm
125 mm



1/4"

1/2"

Juegos de Llaves de Vaso Mixtos • Mixed Socket Sets • Jeux de Douilles Mixtes

500

Maletín Vaso Hexagonal

Hexagonal Socket Case • Coffret de Douilles Hexagonales

108

Pcs



385 x 274 x 88 mm

Part N°	€
500-026	493,65

1/4"

Vasos • Sockets • Douilles

4 • 4,5 • 5 • 5,5 • 6 • 7 • 8 • 9 • 10
11 • 12 • 13 • 14

Vasos • Sockets • Douilles

E4 • E5 • E6 • E7 • E8

Vasos con Puntas • Socket Bits • Douilles-Embouts de Vissage

HX3 • HX4 • HX5 • HX6

4 • 5,5 • 6,5

Llave de Carraca
Ratched Handle • Cliquet

72 dientes
72 teeth • 72 dents

Destornillador • Spinner Handle • Tournevis

Mango Corredizo en "T" • Sliding "T" Handle • Manche en "T" à Glissement

Serie Larga • Deep • Série Longue

6 • 7 • 8 • 9 • 10 • 11 • 12 • 13

T8 • T10 • T15 • T20 • T25 • T27 • T30

PH1 • PH2

PZ1 • PZ2

Articulación Universal
Universal Joint • Cardan Universel

Alargadores • Extensions • Rallonges

75 mm
50 mm

1/2"

Vasos • Sockets • Douilles

10 • 11 • 12 • 13 • 14 • 15 • 16 • 17 • 18
19 • 20 • 21 • 22 • 24 • 27 • 30 • 32

Vasos • Sockets • Douilles

E10 • E11 • E12 • E14
E16 • E18 • E20 • E22

5/16" • Puntas de Atornillar • Screwdriver Bits • Embouts de Vissage

HX7 • HX8 • HX10 • HX12 • HX14

PZ3 • PZ4

Llave de Carraca • Ratched Handle • Cliquet

72 dientes
72 teeth • 72 dents

Articulación Universal
Universal Joint • Cardan Universel

Adaptador Triple Función
3-Way Adapter • Adaptateur avec Triple Fonction

3/8" • 1/2"

Serie Larga • Deep • Série Longue

14 • 15 • 17 • 19 • 22

Bujías • Spark Plug • Bougies

16 • 21

T40 • T45 • T50 • T55 • T60

8 • 10 • 12

Llaves Allen • Hex Key Wrenches • Clés Allen

1,5 • 2 • 2,5

Alargadores • Extensions • Rallonges

250 mm
125 mm

Portapuntas Cuadrado de Arrastre
Square Drive Bit Holder
Douille Porte-embouts à carré d'entraînement

5/16" • 1/2"

Juegos de Llaves de Vaso Mixtos • Mixed Socket Sets • Jeux de Douilles Mixtes

1/4" 1/2"

500

Bandeja Combinable Vaso Hexagonal

Hexagonal Socket EVA Foam Tray • Panneau de Mousse Modulable Douilles Hexagonales

43
Pcs



1/2 (375 x 280 X 30 mm)

Part N°	€
500-080	362,12

1/2"

Vasos • Sockets • Douilles

10 • 11 • 12 • 13 • 14 • 15 • 16 • 17 • 18
19 • 20 • 21 • 22 • 24 • 27 • 30 • 32

Llave de Carraca • Ratched Handle • Cliquet



72 dientes
72 teeth • 72 dents

Articulación Universal

Universal Joint • Cardan Universel



para Bujías • Spark Plug • pour Bougies

16 • 21

Alargadores • Extensions • Rallonges

250 mm
125 mm

Adaptador Triple Función

3-Way Adapter • Adaptateur avec Triple Fonction

3/8" 1/2"

1/4"

Vasos • Sockets • Douilles

4 • 4,5 • 5 • 5,5 • 6 • 7 • 8 • 9 • 10 • 11 • 12 • 13 • 14

Llave de Carraca • Ratched Handle • Cliquet



72 dientes
72 teeth • 72 dents

Articulación Universal

Universal Joint • Cardan Universel



Alargadores • Extensions • Rallonges

100 mm
50 mm

Mango Corredizo en T

Sliding "T" Handle • Manche en "T" à Glissement

115 mm

Destornillador • Spinner Handle • Tournevis



501

Bandeja Combinable Vaso Bihexagonal

Bi-hexagonal Socket EVA Foam Tray • Panneau de Mousse Modulable Douilles Bi-Hexagonales

43
Pcs



1/2 (375 x 280 X 30 mm)

Part N°	€
501-080	362,12

1/2"

Vasos • Sockets • Douilles

10 • 11 • 12 • 13 • 14 • 15 • 16 • 17 • 18
19 • 20 • 21 • 22 • 24 • 27 • 30 • 32

Llave de Carraca • Ratched Handle • Cliquet



72 dientes
72 teeth • 72 dents

Articulación Universal

Universal Joint • Cardan Universel



para Bujías • Spark Plug • pour Bougies

16 • 21

Alargadores • Extensions • Rallonges

250 mm
125 mm

Adaptador Triple Función

3-Way Adapter • Adaptateur avec Triple Fonction

3/8" 1/2"

1/4"

Vasos • Sockets • Douilles

4 • 4,5 • 5 • 5,5 • 6 • 7 • 8 • 9 • 10 • 11 • 12 • 13 • 14

Llave de Carraca • Ratched Handle • Cliquet



72 dientes
72 teeth • 72 dents

Articulación Universal

Universal Joint • Cardan Universel



Alargadores • Extensions • Rallonges

100 mm
50 mm

Mango Corredizo en T

Sliding "T" Handle • Manche en "T" à Glissement

115 mm

Destornillador • Spinner Handle • Tournevis



1/4"

1/2"

Juegos de Llaves de Vaso Mixtos • Mixed Socket Sets • Jeux de Douilles Mixtes

503

Bandeja Combinable Vaso Torx

Torx Socket EVA Foam Tray • Panneau de Mousse Modulable Douilles Torx

29
Pcs



1/4 (375 x 140 x 30 mm)

1/4"



E4 • E5 • E6 • E7 • E8



T6 • T7 • T8 • T9 • T10 • T15

1/2"



E10 • E11 • E12 • E14 • E16 • E18 • E20 • E22 • E24



TS20 • TS25 • TS27 • TS30 • TS40 • TS45 • TS50 • TS55 • TS60

Part N°	€
503-080	232,42

Ver Información Ampliada sobre Almacenaje y Bandejas Combinables en Páginas:

For Further Information About Storage and Eva Foam Trays:

Voir pour Plus d'information sur le Rangement et Panneaux de Mousse Modulables Pages:

10 • 11

Juegos de Llaves de Vaso Mixtos • Mixed Socket Sets • Jeux de Douilles Mixtes

1/4" 3/8" 1/2"

500

Maletín Vaso Hexagonal
Hexagonal Socket Case • Coffret de Douilles Hexagonales

151
Pcs



435 x 305 x 95 mm

Part N°	€
500-027	681,19

1/4"

Vasos • Sockets • Douilles
4 • 4,5 • 5 • 5,5 • 6 • 7 • 8 • 9 • 10
11 • 12 • 13 • 14

Vasos • Sockets • Douilles

E4 • E5 • E6 • E7 • E8

Vasos con Puntas • Socket Bits • Douilles-Embouts de Vissage

HX3 • HX4
HX5 • HX6

T8 • T9 • T10 • T15
T20 • T25 • T27 • T30

TS8 • TS9 • TS10 • TS15
TS20 • TS25 • TS27 • TS30

4 • 5,5 • 6,5 • 7

PH0 • PH1 • PH2

PZ0 • PZ1 • PZ2

Llave de Carraca
Ratched Handle • Cliquet

72 dientes
72 teeth • 72 dents

Destornillador • Spinner Handle • Tournevis



Mango Corredizo en "T" • Sliding "T" Handle • Manche en "T" à Glissement



Serie Larga • Deep • Série Longue

4 • 5 • 6 • 7 • 8 • 9 • 10

Articulación Universal
Universal Joint • Cardan Universel



Alargadores • Extensions • Rallonges

100 mm
50 mm

3/8"

Vasos • Sockets • Douilles
10 • 11 • 12 • 13 • 14 • 15 • 16 • 17 •
18 • 19

Vasos • Sockets • Douilles

E10 • E11 • E12 • E14 • E16 • E18

Llave de Carraca • Ratched Handle • Cliquet

72 dientes
72 teeth • 72 dents

Articulación Universal
Universal Joint • Cardan Universel



Serie Larga • Deep • Série Longue

10 • 11 • 12 • 13 • 14 • 15

Bujías • Spark Plug • Bougies

18

Alargadores • Extensions • Rallonges

125 mm

Portapuntas
Bit Coupler • Porte-embouts

5/16" ▶ ◀ 3/8"

1/2"

Vasos • Sockets • Douilles
10 • 11 • 12 • 13 • 14 • 15 • 16 • 17 • 18
19 • 20 • 21 • 22 • 24 • 27 • 30 • 32

Vasos • Sockets • Douilles

E20 • E24

5/16" • Puntas de Atornillar • Screwdriver Bits • Embouts de Vissage

HX7 • HX8 • HX10
HX12 • HX14

T40 • T45 • T50
T55 • T60 • T70

TS40 • TS45 • TS50
TS55 • TS60 • TS70

8 • 10 • 12

PH3 • PH4

PZ3 • PZ4

Llave de Carraca • Ratched Handle • Cliquet

72 dientes
72 teeth • 72 dents

Articulación Universal
Universal Joint • Cardan Universel



Adaptador Triple Función
3-Way Adapter • Adaptateur avec Triple Fonction

3/8" ▶ ◀ 1/2"

Serie Larga • Deep • Série Longue

16 • 17 • 18 • 19 • 22

Bujías • Spark Plug • Bougies

16 • 21

Llaves Allen • Hex Key Wrenches • Clés Allen

1,27 • 1,5 • 2
2,5 • 3 • 4 • 5

Alargadores • Extensions • Rallonges

250 mm
125 mm

Portapuntas
Bit Coupler • Porte-embouts

5/16" ▶ ◀ 1/2"

1/4" 3/8" 1/2"

Juegos de Llaves de Vaso Mixtos • Mixed Socket Sets • Jeux de Douilles Mixtes

503

Torx • Torx • Torx

11
Pcs



-  E4 • E5 • E6 • E7
-  E8 • E10 • E12
-  E14 • E16 • E18 • E20

Part N°	€
503-051	62,13

502

Bandeja Combinable Vaso Hexagonal Serie Larga

Hexagonal Socket Long Series EVA Foam Tray • Panneau de Mousse Modulable Douilles Hexagonales Série Longue

18
Pcs



1/4 (375 x 140 x 30 mm)

-  4 • 5 • 6 • 7 • 8 • 9 • 10
-  10 • 11 • 12 • 13 • 14 • 15
-  16 • 17 • 18 • 19 • 22

Part N°	€
502-080	169,88

Ver Información Ampliada sobre Almacenaje y Bandejas Combinables en Páginas:

For Further Information About Storage and Eva Foam Trays:

Voir pour Plus d'information sur le Rangement et Panneaux de Mousse Modulables Pages:

10 • 11

549

Hexagonal • Hexagonal • Hexagonale

3/4"



CrV



mm	L mm	Part N°	€
19	50	549-19	13,78
22	50	549-22	13,90
23	50	549-23	14,13
24	50	549-24	14,28
25	52	549-25	14,73
26	52	549-26	14,88
27	52	549-27	15,31
28	52	549-28	15,31
29	52	549-29	15,33
30	54	549-30	17,11
32	56	549-32	17,59
33	56	549-33	19,49
34	56	549-34	19,49
35	58	549-35	19,63
36	58	549-36	19,97
38	60	549-38	22,20
40	60	549-40	23,15
41	64	549-41	24,23
42	64	549-42	24,98
46	68	549-46	28,68
50	72	549-50	32,89
55	76	549-55	34,00
60	78	549-60	38,53

SAE

	L mm	Part N°	€
15/16"	50	549-15/16	14,51
1"	52	549-1	16,77
1.1/16"	52	549-1.1/16	16,88
1.1/8"	52	549-1.1/8	16,96
1.3/16"	54	549-1.3/16	17,20
1.1/4"	56	549-1.1/4	17,36
1.5/16"	56	549-1.5/16	18,80
1.3/8"	58	549-1.3/8	19,47
1.7/16"	58	549-1.7/16	19,98
1.1/2"	60	549-1.1/2	23,07
1.5/8"	64	549-1.5/8	24,52
1.11/16"	64	549-1.11/16	27,29
1.3/4"	68	549-1.3/4	28,88
1.13/16"	68	549-1.13/16	30,71
1.7/8"	72	549-1.7/8	31,47
2"	72	549-2	34,20

3/4"

548

Bihexagonal • Bihexagonal • Bi-Hexagonale



mm	L mm	Part N°	€
19	50	548-19	13,78
22	50	548-22	13,90
23	50	548-23	14,13
24	50	548-24	14,28
25	52	548-25	14,73
26	52	548-26	14,88
27	52	548-27	15,31
28	52	548-28	15,31
29	52	548-29	15,33
30	54	548-30	17,11
32	56	548-32	17,59
33	56	548-33	19,49
34	56	548-34	19,49
35	58	548-35	19,63
36	58	548-36	19,97
38	60	548-38	22,20
40	60	548-40	23,15
41	64	548-41	24,23
42	64	548-42	24,98
46	68	548-46	28,68
50	72	548-50	32,89
55	76	548-55	34,00
60	78	548-60	38,53

Accesorios para Llaves de Vaso • Accessories for Sockets • Accessoires pour Douilles

553

Alargador • Extension • Rallonge



L mm	Part N°	€
100	553-003	21,93
200	553-005	26,40
400	553-006	39,95

Accesorios para Llaves de Vaso • Accessories for Sockets • Accessoires pour Douilles

3/4"

553 Articulación Universal
Universal Joint • Cardan Universel

3/4"
CrV



Part N°	€
553-009	61,40

553 Adaptador Ampliador
Increasing Adaptor • Augmentateur

3/4"
1"
CrV



3/4"	1"	Part N°	€
		553-011	24,00

553 Adaptador Reductor
Reducing Adaptor • Réducteur

3/4"
1/2"
CrV



3/4"	1/2"	Part N°	€
		553-012	19,68

553 Mango Corredizo en "T" con Tope Lateral
Sliding "T" Handle with Side Stopper
Manche en T à Glissement avec Butée de Côté

3/4"
CrV



3/4"	L mm	Part N°	€
	450	553-014	49,98

553 Repuesto de Barra para Mango Corredizo en "T"
Spare Bar for Sliding "T" Handle
Rechange pour Manche en "T" à Glissement

CrV



L mm	Part N°	€
450	553-015	39,50

553 Mango Articulado
Swivel Handle • Manche Articulé

3/4"
CrV



L mm	Part N°	€
500	553-016	54,95

Llaves de Vaso • Sockets • Douilles

3/4"

Llaves de Carraca • Ratchet Handle • Cliquet

554

Llave de Carraca • Ratchet Handle • Cliquet

3/4"

24^{15°}

CrV



TH	L mm	Part N°	€
24 TH	500	554-001	150,23

554

Llave de Carraca Extensible • Extensible Ratchet Handle • Cliquet Extensible

3/4"

60^{6°}

CrV



TH	L mm	Part N°	€
60 TH	930	554-002	174,95

Juegos de Llaves de Vaso • Socket Sets • Jeux de Douilles

3/4"

549

Maletín Vaso Hexagonal

Hexagonal Socket Case • Coffret de Douilles Hexagonales

16

Pcs

3/4"



Vasos • Sockets • Douilles

19 • 22 • 23 • 24 • 27 • 30 • 32 • 36 • 38 • 41 • 46 • 50

Llave de Carraca • Ratched Handle • Cliquet

500 mm • 24 dientes • 24 teeth • 24 dents

Alargadores
Extensions • Rallonges

200 mm
100 mm

Mango Corredizo en "T"
Sliding "T" Handle • Manche en "T" à Glissement

450 mm

Part N°	€
549-001	492,58

549

Maletín Vaso Hexagonal

Hexagonal Socket Case • Coffret de Douilles Hexagonales

20

Pcs

3/4"



Vasos • Sockets • Douilles

19 • 22 • 23 • 24 • 25 • 26 • 27 • 29 • 30 • 32 • 35 • 36 • 38 • 41 • 46 • 50

Llave de Carraca • Ratched Handle • Cliquet

500 mm • 24 dientes • 24 teeth • 24 dents

Alargadores
Extensions • Rallonges

200 mm
100 mm

Mango Corredizo en "T"
Sliding "T" Handle • Manche en "T" à Glissement

450 mm

Part N°	€
549-002	557,13

1"

558

Hexagonal • Hexagonal • Hexagonale



mm	L mm	Part N°	€
41	70	558-41	32,75
46	75	558-46	40,30
50	75	558-50	42,14
54	80	558-54	45,91
55	80	558-55	53,88
58	80	558-58	56,63
60	84	558-60	58,74
63	87	558-63	65,85
65	87	558-65	70,31
67	90	558-67	74,78
70	93	558-70	79,12
71	93	558-71	85,05
75	97	558-75	92,53
77	103	558-77	97,45
80	103	558-80	100,54

SAE

mm	L mm	Part N°	€
1.5/8"	70	558-1.5/8	41,12
1.13/16"	75	558-1.13/16	48,65
1.7/8"	75	558-1.7/8	51,44
2"	75	558-2	52,83
2.1/8"	80	558-2.1/8	56,08
2.3/16"	80	558-2.3/16	60,37
2.1/4"	80	558-2.1/4	67,05
2.3/8"	84	558-2.3/8	73,46
2.1/2"	87	558-2.1/2	82,38
2.5/8"	90	558-2.5/8	93,69
2.3/4"	93	558-2.3/4	99,12
2.15/16"	97	558-2.15/16	112,09
3"	103	558-3	117,94
3.1/8"	103	558-3.1/8	125,88

Accesorios para Llaves de Vaso • Accessories for Sockets • Accessoires pour Douilles

559

Alargador • Extension • Rallonge



L mm	Part N°	€
225	559-005	60,30
400	559-006	69,13

Accesorios para Llaves de Vaso • Accessories for Sockets • Accessoires pour Douilles

1"

559 Adaptador Reductor
Reducing Adaptor • Réducteur

1"
3/4"
CrV



1"	3/4"	Part N°	€
		559-012	39,13

559 Mango Corredizo en "T" con Tope Lateral
Sliding "T" Handle with Side Stopper
Manche en T à Glissement avec Butée de Côté

1"
CrV



1"	L mm	Part N°	€
	500	559-014	69,18

560 Llave de Carraca • Ratchet Handle • Cliquet

1"
24 (15°)
CrV

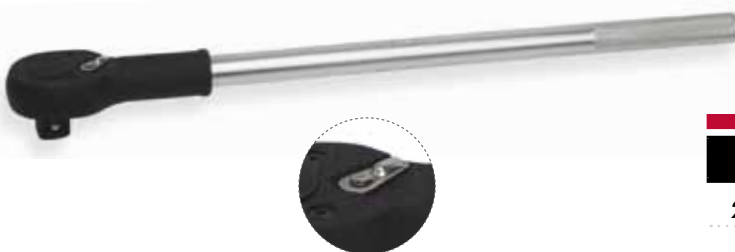

TH	L mm	Part N°	€
24 TH	650	560-001	219,95

Juegos de Llaves de Vaso • Socket Sets • Jeux de Douilles

558 Estuche Vaso Hexagonal
Hexagonal Socket Case • Coffret de Douilles Hexagonales

12
Pcs

1"



Vasos • Sockets • Douilles

46 • 50 • 55 • 60 • 65 • 70 • 75 • 80

Llave de Carraca • Ratched Handle • Cliquet

650 mm • 24 dientes • 24 teeth • 24 dents

Adaptador • Adapter • Adaptateur

3/4 (M) ▶ ◀ 1" (F)

Mango Corredizo en "T"
Sliding "T" Handle • Manche en "T" à Glissement

550 mm

Alargador
Extension • Rallonge

200 mm

Part N°	€
558-001	880,81

3/8"

562

Hexagonal • Hexagonal • Hexagonale

3/8"



CrMo



mm	L mm	Part N°	€
7	30	562-07	6,85
8	30	562-08	6,85
9	30	562-09	6,85
10	30	562-10	6,85
11	30	562-11	6,85
12	30	562-12	6,85
13	30	562-13	6,85
14	30	562-14	6,85
15	30	562-15	7,28
16	30	562-16	7,28
17	30	562-17	7,28
18	30	562-18	7,28
19	30	562-19	7,28
20	30	562-20	8,77
21	30	562-21	8,97
22	30	562-22	9,10
24	30	562-24	10,87

565

Hexagonal Serie Larga

Hexagonal Long Series • Hexagonale Série Longue

3/8"



CrMo



mm	L mm	Part N°	€
10	64	565-10	11,99
13	64	565-13	11,99
17	64	565-17	14,02

564

Torx • Torx • Torx

3/8"



CrMo



mm	L mm	Part N°	€
E5	28	564-T05	8,35
E7	28	564-T07	8,35
E8	28	564-T08	8,35
E10	28	564-T10	8,35
E12	28	564-T12	8,35
E14	28	564-T14	8,35

594 Articulación Universal
Universal Joint • Cardan Impact

3/8"
CrMo



L mm	Part N°	€
50	594-001	36,35

594 Alargador
Extension • Rallonge

3/8"
CrMo



L mm	Part N°	€
75	594-005	12,85
150	594-006	15,66

594 Adaptador Ampliador
Increasing Adaptor • Augmentateur

3/8"
1/2"
CrMo



3/8"	1/2"	Part N°	€
		594-025	18,99

594 Adaptador Reductor
Reducing Adaptor • Réducteur

3/8"
1/4"
CrMo



3/8"	1/4"	Part N°	€
		594-029	16,92

Llaves de Vaso de Impacto • Impact Sockets • Douilles Impact

1/2"

570

Hexagonal • Hexagonal • Hexagonale



Ø mm	L mm	Part N°	€
8	38	570-08	7,80
9	38	570-09	8,25
10	38	570-10	8,30
11	38	570-11	8,31
12	38	570-12	8,41
13	38	570-13	8,56
14	38	570-14	8,76
15	38	570-15	9,11
16	38	570-16	9,15
17	38	570-17	9,20
18	38	570-18	9,25
19	38	570-19	9,25
20	38	570-20	10,77
21	38	570-21	10,97
22	38	570-22	10,97
23	38	570-23	11,58
24	38	570-24	12,00
25	42	570-25	12,64
26	42	570-26	13,30
27	42	570-27	13,86
28	42	570-28	15,20
29	42	570-29	15,20
30	42	570-30	15,20
32	42	570-32	18,45
34	48	570-34	25,01
36	48	570-36	25,55

SAE

Ø	L mm	Part N°	€
3/8"	38	570-3/8	8,38
7/16"	38	570-7/16	8,59
1/2"	38	570-1/2	8,84
9/16"	38	570-9/16	9,05
5/8"	38	570-5/8	9,25
11/16"	38	570-11/16	9,50
3/4"	38	570-3/4	9,46
13/16"	38	570-13/16	11,08
7/8"	38	570-7/8	11,08
15/16"	38	570-15/16	12,02
1"	42	570-1	12,66
1.1/8"	42	570-1.1/8	16,26
1.1/4"	42	570-1.1/4	27,38

1/2"

571

Hexagonal Serie Larga
Hexagonal Long Series • Hexagonale Série Longue

1/2"



CrMo



mm	L mm	Part N°	€
10	82	571-10	15,43
11	82	571-11	15,43
12	82	571-12	15,43
13	82	571-13	15,43
14	82	571-14	15,43
16	82	571-16	16,08
17	82	571-17	16,08
18	82	571-18	17,10
19	82	571-19	17,10
21	82	571-21	18,38
22	82	571-22	18,38
23	82	571-23	18,77
24	82	571-24	19,75
27	82	571-27	22,92
30	82	571-30	27,97
32	82	571-32	29,32
36	82	571-36	36,37

572

Torx • Torx • Torx

1/2"



CrMo



mm	L mm	Part N°	€
E10	38	572-T10	10,25
E12	38	572-T12	10,25
E14	38	572-T14	10,25
E16	38	572-T16	10,25
E18	38	572-T18	10,25
E20	38	572-T20	11,59
E24	38	572-T24	12,07

575

Hexagonal • Hexagonal • Hexagonale

1/2"



mm	L mm	Part N°	€
17	85	575-17 ■	20,52
19	85	575-19 ■	23,46
21	85	575-21 ■	23,46

Llaves de Vaso de Impacto • Impact Sockets • Douilles Impact

1/2"

Llaves de Vaso de Impacto con Punta • Impact Socket Bits • Douilles - Embouts de Vissage Impact

573

Punta Hexagonal • Hexagonal • Hexagonal



	L mm	Part N°	€
HX5	78	573-05	19,54
HX6	78	573-06	21,02
HX8	78	573-08	21,04
HX10	78	573-10	22,88
HX12	78	573-12	22,94
HX14	78	573-14	23,54
HX17	78	573-17	23,80
HX19	78	573-19	23,92

574

Punta Torx • Torx • Torx



	L mm	Part N°	€
T25	40	574-T25	15,49
T27	40	574-T27	15,49
T30	40	574-T30	16,90
T40	40	574-T40	16,90
T45	40	574-T45	16,90
T50	40	574-T50	18,78
T55	40	574-T55	20,01
T60	40	574-T60	22,02

Accesorios para Llaves de Vaso de Impacto • Accessories for Impact Sockets • Accessoires pour Douilles Impact

594

Articulación Universal
Universal Joint • Cardan Impact



L mm	Part N°	€
63	594-002	39,18

594

Alargador
Extension • Rallonge



L mm	Part N°	€
75	594-007	16,26
125	594-008	17,51
250	594-009	19,85

Accesorios para Llaves de Vaso de Impacto • Accessories for Impact Sockets • Accessoires pour Douilles Impact

1/2"

594

Adaptador Ampliador
Increasing Adaptor • Augmentateur

- 1/2"
- 3/4"
- CrMo



1/2"	3/4"	Part N°	€
		594-026	21,90

594

Adaptador Reductor
Reducing Adaptor • Réducteur

- 1/2"
- 3/8"
- CrMo



1/2"	3/8"	Part N°	€
		594-030	18,10

Juegos de Llaves de Vaso de Impacto • Impact Socket Sets • Jeux de Douilles Impact

570

Bandeja Combinable Vaso de Impacto Hexagonal
Hexagonal Impact Socket EVA Foam Tray • Panneau de Mousse Modulable Douilles Impact Hexagonales

25
Pcs

1/2"



1/3 (375 x 188 X 30 mm)

Part N°	€
570-080	362,72

Vasos de Impacto • Impact Sockets • Douilles

8 • 9 • 10 • 11 • 12 • 13 • 14 • 15 • 16 • 17 • 18 • 20 • 21 • 22 • 24

Serie Larga
Deep • Série Longue

17 • 19 • 21 • 22 • 24

Vasos Impacto Color
Colour Impact Sockets • Douilles Impact Couleur

17 • 19 • 21

Alargadores • Extensions • Rallonges

125 mm

Adaptador • Adapter • Adaptateur

3/8" • 1/2"

572

Bandeja Combinable Vaso de Impacto Torx y Vaso con Punta
Torx Impact Socket and Socket Bits EVA Foam Tray • Panneau de Mousse Modulable Douilles Impact Hexagonales

23
Pcs

1/2"



1/3 (375 x 188 X 30 mm)

Part N°	€
572-080	405,23

Vasos de Impacto • Impact Sockets • Douilles

E10 • E12 • E14 • E16 • E18 • E20 • E24

T25 • T27 • T30 • T40 • T45 • T50 • T55 • T60

5 • 6 • 8 • 10 • 12 • 14 • 17 • 19

Ver Información Ampliada sobre Almacenaje y Bandejas Combinables en Páginas:

Get Extended Information about Storage and EVA Foam Trays in Pages:

Voir pour Plus d'information sur le Rangement et Panneaux de Mousse Modulables Pages:

10 • 11

Llaves de Vaso de Impacto • Impact Sockets • Douilles Impact

3/4"

578

Hexagonal • Hexagonal • Hexagonale

SAE

mm	L mm	Part N°	€
13/16"	51	578-13/16	21,15
7/8"	51	578-7/8	21,37
15/16"	51	578-15/16	22,23
1"	53	578-1	22,45
1.1/8"	53	578-1.1/8	23,53
1.1/4"	57	578-1.1/4	24,39
1.5/16"	57	578-1.5/16	27,88
1.3/8"	57	578-1.3/8	28,58
1.7/16"	57	578-1.7/16	29,17
1.3/4"	62	578-1.3/4	39,22

mm	L mm	Part N°	€
13	45	578-13	22,65
14	45	578-14	22,65
15	45	578-15	22,65
16	45	578-16	22,65
17	50	578-17	19,44
18	50	578-18	19,44
19	50	578-19	19,44
21	50	578-21	20,05
22	50	578-22	20,10
23	50	578-23	20,86
24	50	578-24	20,86
27	54	578-27	21,37
28	54	578-28	22,07
29	54	578-29	22,07
30	54	578-30	22,07
32	56	578-32	24,57
33	56	578-33	27,95
34	56	578-34	28,80
36	58	578-36	29,52
38	58	578-38	29,89
41	58	578-41	33,52
46	64	578-46	39,60
50	78	578-50	48,71
55	75	578-55	64,79
60	77	578-60	73,04

579

 Hexagonal Serie Larga
 Hexagonal Long Series • Hexagonale Série Longue

mm	L mm	Part N°	€
17	90	579-17	34,35
19	90	579-19	35,04
21	90	579-21	35,73
22	90	579-22	36,00
24	90	579-24	36,30
27	90	579-27	37,55
30	90	579-30	38,48
32	90	579-32	40,08
33	90	579-33	45,01
34	90	579-34	45,82
36	95	579-36	46,53
41	95	579-41	57,23
46	95	579-46	67,34
50	95	579-50	75,46

Llaves de Vaso de Impacto con Punta • Impact Socket Bits • Douilles - Embouts de Vissage Impact

3/4"

580 Punta Hexagonal • Hexagonal • Hexagonale

3/4"



CrMo



	L mm	Part N°	€
HX12	55	580-12	45,49
HX14	55	580-14	50,03
HX17	55	580-17	50,03
HX19	55	580-19	50,03
HX22	55	580-22	59,92
HX24	55	580-24	59,92

Accesorios para Llaves de Vaso de Impacto • Accessories for Impact Sockets • Accessoires pour Douilles Impact

594 Articulación Universal
Universal Joint • Cardan Impact

3/4"

CrMo



L mm	Part N°	€
90	594-003	71,46

594 Alargador
Extension • Rallonge

3/4"

CrMo



L mm	Part N°	€
100	594-010	37,45
175	594-011	42,17
250	594-012	50,31
325	594-013	58,47

594 Adaptador Ampliador
Increasing Adaptor • Augmentateur

3/4"

1"

CrMo



		Part N°	€
3/4"	1"	594-027	52,08

594 Adaptador Reductor
Reducing Adaptor • Réducteur

3/4"

1/2"

CrMo



		Part N°	€
3/4"	1/2"	594-031	38,54

1"

585

Hexagonal • Hexagonal • Hexagonale

SAE

mm	L mm	Part N°	€
1"	60	585-1	35,58
1.1/4"	64	585-1.1/4	37,66
1.7/16"	66	585-1.7/16	39,95
1.7/8"	72	585-1.7/8	62,21

mm	L mm	Part N°	€
19	55	585-19	34,94
20	55	585-20	34,94
21	55	585-21	34,94
22	58	585-22	34,94
24	58	585-24	34,94
27	60	585-27	35,19
28	60	585-28	36,27
29	64	585-29	36,27
30	64	585-30	36,27
32	64	585-32	37,24
33	64	585-33	37,24
34	64	585-34	39,51
36	66	585-36	39,51
38	66	585-38	39,84
40	66	585-40	42,32
41	67	585-41	44,91
42	74	585-42	50,00
46	74	585-46	55,27
50	74	585-50	61,53
55	80	585-55	70,49
60	85	585-60	90,34
65	85	585-65	108,07
70	90	585-70	134,70
75	95	585-75	161,03
80	101	585-80	191,65
85	101	585-85	227,07
90	106	585-90	262,65
95	106	585-95	383,05
100	112	585-100	434,37
105	112	585-105	480,18
110	122	585-110	563,70
115	122	585-115	647,82

586

Hexagonal Serie Larga
Hexagonal Long Series • Hexagonale Série Longue



CrMo



mm	L mm	Part N°	€
22	100	586-22	52,06
24	100	586-24	52,70
27	100	586-27	53,76
30	100	586-30	54,41
32	100	586-32	54,83
33	100	586-33	57,06
34	100	586-34	57,07
36	100	586-36	57,07
38	100	586-38	64,47
41	100	586-41	71,22
46	100	586-46	82,91
50	100	586-50	94,16
55	100	586-55	114,63
60	120	586-60	140,77

Llaves de Vaso de Impacto con Punta • Impact Socket Bits • Douilles - Embouts de Vissage Impact

587

Punta Hexagonal • Hexagonal • Hexagonal



CrMo



	L mm	Part N°	€
HX17	100	587-17	97,50
HX19	100	587-19	97,50
HX22	100	587-22	111,00
HX27	100	587-27	112,50

1" Accesorios para Llaves de Vaso de Impacto • Accessories for Impact Sockets • Accessoires pour Douilles Impact

594 Articulación Universal
Universal Joint • Cardan Impact

1"
CrMo



L mm	Part N°	€
110	594-004	141,95

594 Alargador
Extension • Rallonge

1"
CrMo



L mm	Part N°	€
75	594-014	72,18
175	594-015	84,47
325	594-016	100,91

594 Adaptador Ampliador
Increasing Adaptor • Augmentateur

1"
1.1/12"
CrMo



		Part N°	€
1"	1.1/2"	594-028	82,45

594 Adaptador Reductor
Reducing Adaptor • Réducteur

1"
3/4"
CrMo



		Part N°	€
1"	3/4"	594-032	45,90

590

Hexagonal • Hexagonal • Hexagonale

1.1/2"



CrMo



mm	L mm	Part N°	€
32	75	590-32	149,82
33	75	590-33	149,82
34	75	590-34	149,82
36	80	590-36	157,22
38	80	590-38	157,22
40	80	590-40	157,22
41	80	590-41	157,22
42	80	590-42	157,22
46	84	590-46	157,22
50	87	590-50	157,22
55	90	590-55	166,48
60	92	590-60	184,87
65	96	590-65	212,93
70	101	590-70	247,85
75	105	590-75	268,90
80	110	590-80	295,21
85	116	590-85	339,20
90	118	590-90	376,07
95	118	590-95	503,99
100	125	590-100	541,22
105	125	590-105	596,67
110	137	590-110	869,48
115	137	590-115	914,18

Accesorios para Llaves de Vaso de Impacto • Accessories for Impact Sockets • Accessoires pour Douilles Impact

594

Adaptador Reductor
Reducing Adaptor • Réducteur

1.1/2"

1"

CrMo



1.1/2"	1"	Part N°	€
		594-033	156,00

2.1/2"

591

Hexagonal • Hexagonal • Hexagonale

2.1/2"



CrMo



mm	L mm	Part N°	€
41	115	591-41	788,57
42	115	591-42	788,57
43	115	591-43	788,57
44	115	591-44	788,57
45	115	591-45	788,57
46	115	591-46	788,57
47	115	591-47	788,57
48	115	591-48	788,57
49	115	591-49	788,57
50	115	591-50	788,57
51	115	591-51	788,57
52	115	591-52	788,57
54	115	591-54	818,48
55	115	591-55	818,48
56	115	591-56	818,48
57	115	591-57	818,48
58	115	591-58	818,48
59	115	591-59	818,48
60	115	591-60	818,48
61	115	591-61	833,41
62	115	591-62	833,41
65	115	591-65	833,41
67	115	591-67	833,41
70	115	591-70	833,41
73	125	591-73	833,41
75	125	591-75	833,41
76	125	591-76	833,41
77	125	591-77	833,41
80	125	591-80	833,41
85	130	591-85	900,66
86	130	591-86	986,65
90	132	591-90	986,65
95	132	591-95	1.050,18
100	141	591-100	1.293,11
105	141	591-105	1.306,20
110	150	591-110	1.333,89

mm	L mm	Part N°	€
115	150	591-115	1.471,85
120	158	591-120	1.675,57
125	158	591-125	1.729,77
130	170	591-130	2.059,94
135	174	591-135	2.059,94
140	176	591-140	2.089,53
145	182	591-145	2.089,53
150	190	591-150	2.660,90
155	190	591-155	2.660,90
160	194	591-160	3.079,75
165	201	591-165	3.079,75
170	201	591-170	3.508,45
175	208	591-175	4.198,31
180	214	591-180	4.316,56
185	214	591-185	4.710,76
190	218	591-190	4.986,73
200	226	591-200	5.735,72
210	232	591-210	6.386,18
215	239	591-215	7.390,63
225	258	591-225	7.390,63
235	275	591-235	8.376,05

SAE

	L mm	Part N°	€
1.3/4"	125	591-1.3/4	788,57
1.7/8"	125	591-1.7/8	788,57
2.1/16"	125	591-2.1/16	818,48
2.3/16"	125	591-2.3/16	818,48
2.3/8"	125	591-2.3/8	833,41
2.1/2"	125	591-2.1/2	833,41
2.11/16"	125	591-2.11/16	833,41
2.13/16"	125	591-2.13/16	833,41
3.1/16"	125	591-3.1/16	833,41
3.1/8"	125	591-3.1/8	833,41
3.3/16"	125	591-3.3/16	900,66
3.1/4"	125	591-3.1/4	900,66
3.5/16"	125	591-3.5/16	900,66
3.7/16"	125	591-3.7/16	986,65
3.1/2"	125	591-3.1/2	986,65
3.9/16"	132	591-3.9/16	986,65
3.5/8"	132	591-3.5/8	986,65
3.11/16"	132	591-3.11/16	986,65
3.13/16"	140	591-3.13/16	998,80
3.7/8"	140	591-3.7/8	998,80
4"	142	591-4	998,80
4.1/16"	142	591-4.1/16	998,80
4.3/16"	155	591-4.3/16	1.253,07

592

Hexagonal • Hexagonal • Hexagonale

3.1/2"



CrMo



mm	L mm	Part N°	€
100	165	592-100	2.446,35
105	165	592-105	2.446,35
110	174	592-110	2.446,35
115	174	592-115	2.515,10
120	182	592-120	2.716,99
125	182	592-125	2.716,99
130	198	592-130	2.716,99
135	198	592-135	3.396,26
140	205	592-140	3.614,57
145	212	592-145	3.905,71
150	212	592-150	3.905,71
155	214	592-155	4.172,52
160	218	592-160	4.633,43
165	230	592-165	4.633,43
170	230	592-170	5.361,25
175	230	592-175	5.361,25
180	237	592-180	6.355,82
185	237	592-185	6.355,82
190	242	592-190	6.719,70
200	249	592-200	7.277,68
210	256	592-210	8.732,32
215	263	592-215	10.430,28
225	273	592-225	10.430,28
235	279	592-235	10.891,15

SAE

	L mm	Part N°	€
4"	165	592-4	2.446,35
4.1/16"	165	592-4.1/16	2.446,35
4.3/16"	174	592-4.3/16	2.446,35

1/2"

3/4"

1"

Accesorios para Llaves de Vaso de Impacto • Accessories for Impact Sockets • Accessoires pour Douilles Impact

594
Anillas de Impacto de Seguridad

Impact Socket Rings • Bagues Impact Sécurité

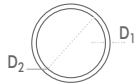

		D ₁ mm	D ₂ mm		Part N°	€
1/2"	≤ 14	4	19	5	• 594-051	2,10
1/2"	≥ 14	4	24	5	594-052	2,10
3/4"	≤ 50	5	36	5	• 594-053	2,10
3/4"	≥ 54	5	46	5	594-054	2,10
1"	≤ 70	7	45	5	• 594-055	2,10

- Ref. aptas tanto para las llaves de vaso indicadas como para sus accesorios
 Ref. suitable for above detailed sockets and their accessories
 Réf. aptes pour les douilles indiquées dans le tableau et leurs accessoires

594
Pasadores de Impacto de Seguridad

Impact Socket Pins • Goupilles Impact Sécurité



		L mm	D mm		Part N°	€
1/2"	≤ 14	20	3	5	• 594-061	1,78
1/2"	≥ 14	25	3	5	594-062	1,78
3/4"	≤ 50	35	4	5	• 594-063	1,78
3/4"	≥ 54	45	4	5	594-064	1,78
1"	≤ 70	45	6	5	• 594-065	1,78

- Ref. aptas tanto para las llaves de vaso indicadas como para sus accesorios
 Ref. suitable for above detailed sockets and their accessories
 Réf. aptes pour les douilles indiquées dans le tableau et leurs accessoires

Llaves Macho
Key Wrenches
Clés Mâles



		256
		258
		261
		262
		262
		263
		264



Llaves Macho • Key Wrenches • Clés Mâles

Llaves Macho a Granel • Bulk Key Wrenches • Clés Mâles
600
Hexagonal Corta

Short Hex • Hexagonale Courte



mm	L1 mm	L2 mm		Part N°	€
1,5	45	14	10	600-01,5	0,52
2	50	16	10	600-02	0,54
2,5	56	18	10	600-02,5	0,61
3	63	20	10	600-03	0,69
4	70	25	10	600-04	0,79
5	80	28	10	600-05	0,93
6	90	32	10	600-06	1,12
7	95	34	10	600-07	1,52
8	100	36	10	600-08	1,73
9	105	38	10	600-09	2,19
10	112	40	10	600-10	2,31
12	125	45	5	600-12	3,86
14	140	56	5	600-14	5,75
17	160	63	5	600-17	9,00
19	180	70	5	600-19	12,48
22	200	80	5	600-22	19,50

SAE

	L1 mm	L2 mm		Part N°	€
1/16"	43,5	13,5	10	600-1/16	0,38
5/64"	49	15	10	600-5/64	0,41
3/32"	52	16	10	600-3/32	0,45
1/8"	56	18	10	600-1/8	0,58
5/32"	63	21	10	600-5/32	0,68
3/16"	69	23	10	600-3/16	0,76
7/32"	75	25	10	600-7/32	0,94
1/4"	82	28	10	600-1/4	1,15
5/16"	94	31	10	600-5/16	1,87
3/8"	107	34	10	600-3/8	2,71
7/16"	120	37	5	600-7/16	4,15
1/2"	133	40	5	600-1/2	5,06
5/8"	156	45,5	5	600-5/8	9,13
3/4"	183	53	5	600-3/4	15,76

602
Hexagonal Extra Larga

Extra Long Hex

Hexagonale Extra Longue



mm	L1 mm	L2 mm		Part N°	€
1,5	90	14	10	602-01,5	0,70
2	100	15	10	602-02	0,71
2,5	112	18	10	602-02,5	0,82
3	126	20	10	602-03	0,98
4	142	25	10	602-04	1,13
5	160	28	10	602-05	1,34
6	180	32	10	602-06	1,59
7	190	34	10	602-07	2,31
8	200	36	10	602-08	2,68
9	210	38	5	602-09	3,36
10	224	40	5	602-10	3,77
12	250	45	5	602-12	6,25
14	280	55	5	602-14	7,75

 • Consulte envase unitario con colgador
 Hanging unit packaging available
 Nous consulter pour présentation brochable

Llaves Macho a Granel • Bulk Key Wrenches • Clés Mâles

605

Hexagonal Redonda Extra Larga
Extra Long Ball Nose Hex
Hexagonale Extra Longue Tête Sphérique



CrV



mm	L1 mm	L2 mm		Part N°	€
1,5	90	14	10	605-01,5	1,11
2	100	15	10	605-02	1,26
2,5	112	18	10	605-02,5	1,32
3	126	20	10	605-03	1,37
4	142	25	10	605-04	1,62
5	160	28	10	605-05	2,05
6	180	32	10	605-06	2,90
7	190	34	10	605-07	3,75
8	200	36	5	605-08	4,07
10	224	40	5	605-10	5,28
12	250	45	5	605-12	8,73
14	280	55	5	605-14	10,25

SAE

mm	L1 mm	L2 mm		Part N°	€
1/16 "	89	13	10	605-1/16	0,80
5/64 "	99	15	10	605-5/64	0,80
3/32 "	110	17	10	605-3/32	1,00
1/8 "	124	19	10	605-1/8	1,08
5/32 "	138	23,5	10	605-5/32	1,53
3/16 "	158	28	10	605-3/16	1,84
7/32 "	170	29	10	605-7/32	2,03
1/4 "	178	31	10	605-1/4	2,27
5/16 "	196	35	10	605-5/16	3,72
3/8 "	220	37	10	605-3/8	5,67
7/16 "	234	38	5	605-7/16	8,66
1/2 "	247	41	5	605-1/2	8,66
5/8 "	316	47	5	605-5/8	22,09
3/4 "	355	54	5	605-3/4	32,44

608

Torx Extra Larga
Extra Long Torx • Torx Extra Longue



CrV



mm	L1 mm	L2 mm		Part N°	€
T06	66	16	10	608-T06	4,92
T07	71	16	10	608-T07	4,92
T08	76	16	10	608-T08	4,92
T09	80	16	10	608-T09	4,92
T10	86	17	10	608-T10	3,94
T15	90	18	10	608-T15	4,02
T20	95	19	10	608-T20	4,20
T25	100	20	10	608-T25	4,23
T27	105	21	5	608-T27	4,32
T30	114	24	5	608-T30	4,39
T40	124	26	5	608-T40	4,55
T45	137	29	5	608-T45	4,94
T50	152	32	5	608-T50	5,42
T55	171	35	5	608-T55	7,65
T60	190	38	5	608-T60	9,11



• Consulte envase unitario con colgador
Hanging unit packaging available
Nous consulter pour présentation brochable

Llaves Macho • Key Wrenches • Clés Mâles

Llaves Macho a Granel • Bulk Key Wrenches • Clés Mâles

611

Torx Seguridad Extra Larga
Extra Long Torx Tamper • Torx Sécurité Extra Longue



• Consulte envase unitario con colgador
Hanging unit packaging available
Nous consulter pour présentation brochable

	L1 mm	L2 mm		Part N°	€
TS06	66	16	10	611-TS06	6,39
TS07	71	16	10	611-TS07	6,39
TS08	76	16	10	611-TS08	6,39
TS09	80	16	10	611-TS09	6,39
TS10	86	17	10	611-TS10	5,12
TS15	90	18	10	611-TS15	5,22
TS20	95	19	10	611-TS20	5,46
TS25	100	20	10	611-TS25	5,50
TS27	105	21	5	611-TS27	5,62
TS30	114	24	5	611-TS30	5,70
TS40	124	26	5	611-TS40	5,91
TS45	137	29	5	611-TS45	6,42
TS50	152	32	5	611-TS50	7,05
TS55	171	35	5	611-TS55	9,95
TS60	190	38	5	611-TS60	11,85

Juegos de Llaves Macho • Key Wrench Sets • Jeux de Clés Mâles



600

Hexagonal Corta
Short Hex • Hexagonale Courte

9

Pcs



1,5 • 2 • 2,5 • 3 • 4 • 5 • 6 • 8 • 10 mm

Part N°	€
600-009	11,00

600

Hexagonal Corta
Short Hex • Hexagonale Courte

9

Pcs

SAE



1/16 • 5/64 • 3/32 • 1/8 • 5/32 • 3/16 • 1/4 • 5/16 • 3/8"

Part N°	€
600-002	11,00



Juegos de Llaves Macho • Key Wrench Sets • Jeux de Clés Mâles

602

Hexagonal Extra Larga
Extra Long Hex • Hexagonale Extra Longue

9

Pcs



1,5 · 2 · 2,5 · 3 · 4 · 5 · 6 · 8 · 10 mm

Part N°	€
602-009	16,00

603

Hexagonal Redonda Corta
Short Ball Nose hex
Hexagonale Courte Tête Sphérique

9

Pcs



1,5 · 2 · 2,5 · 3 · 4 · 5 · 6 · 8 · 10 mm

Part N°	€
603-009	14,73

605

Hexagonal Redonda Extra Larga
Extra Long Ball Nose Hex
Hexagonale Extra Longue Tête Sphérique

9

Pcs



1,5 · 2 · 2,5 · 3 · 4 · 5 · 6 · 8 · 10 mm

Part N°	€
605-009	22,48

605

Hexagonal Redonda Extra Larga
Extra Long Ball Nose Hex
Hexagonale Extra Longue Tête Sphérique

9

Pcs



1/16 · 5/64 · 3/32 · 1/8 · 5/32 · 3/16 · 1/4 · 5/16 · 3/8"

Part N°	€
605-002	22,48

Juegos de Llaves Macho • Key Wrench Sets • Jeux de Clés Mâles



606

Torx Corta
Short Torx • Torx Courte

9

Pcs



T10 • T15 • T20 • T25 • T27 • T30 • T40 • T45 • T50

Part N°	€
606-009	21,95

608

Torx Extra Larga
Extra Long Torx • Torx Extra Longue

9

Pcs



T10 • T15 • T20 • T25 • T27 • T30 • T40 • T45 • T50

Part N°	€
608-009	32,28

609

Torx Seguridad Corta
Short Torx Tamper • Torx Sécurité Courte

9

Pcs



TS10 • TS15 • TS20 • TS25 • TS27 • TS30 • TS40 • TS45 • TS50

Part N°	€
609-009	26,65

611

Torx Seguridad Extra Larga
Extra Long Torx Tamper • Torx Sécurité Extra Longue

9

Pcs



TS10 • TS15 • TS20 • TS25 • TS27 • TS30 • TS40 • TS45 • TS50

Part N°	€
611-009	37,69

Juegos de Llaves Macho • Key Wrench Sets • Jeux de Clés Mâles

600

Hexagonal Corta
Short Hex • Hexagonale Courte

7
Pcs



1,5 · 2 · 2,5 · 3 · 4 · 5 · 6 mm

Part N°	€
600-007	5,65

603

Hexagonal Redonda Corta
Short Ball Nose hex
Hexagonale Courte Tête Sphérique

7
Pcs



1,5 · 2 · 2,5 · 3 · 4 · 5 · 6 mm

Part N°	€
603-007	7,43

606

Torx Corta
Short Torx • Torx Courte

7
Pcs



T10 · T15 · T20 · T25 · T27 · T30 · T40

Part N°	€
606-007	11,25

609

Torx Seguridad Corta
Short Torx Tamper • Torx Sécurité Courte

7
Pcs

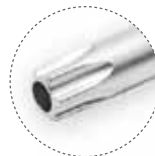

TS10 · TS15 · TS20 · TS25 · TS27 · TS30 · TS40

Part N°	€
609-007	13,75

Llaves Macho • Key Wrenches • Clés Mâles

Juegos de Llaves Macho en Anilla • Ring type Key Wrench Sets • Jeux de Clés Mâles sur Anneau

600

Hexagonal Corta
Short Hex • Hexagonale Courte

7
Pcs



2 · 2,5 · 3 · 4 · 5 · 6 · 8 mm

Part N°	€
600-027	7,50

600

Hexagonal Corta
Short Hex • Hexagonale Courte

9
Pcs



1,5 · 2 · 2,5 · 3 · 4 · 5 · 6 · 8 · 10 mm

Part N°	€
600-029	10,00

Juegos de Llaves Macho en Canutillo • Bucket type Key Wrench Sets • Jeux de Clés Mâles

602

Hexagonal Extra Larga
Extra Long Hex • Hexagonale Extra Longue

7
Pcs



1,5 · 2 · 2,5 · 3 · 4 · 5 · 6 mm

Part N°	€
602-037	13,90

605

Hexagonal Redonda Extra Larga
Extra Long Ball Nose Hex
Hexagonale Extra Longue Tête Sphérique

7
Pcs



1,5 · 2 · 2,5 · 3 · 4 · 5 · 6 mm

Part N°	€
605-037	15,30

Juegos de Llaves Macho en Navaja • Key Wrench Folding Sets • Jeux de Clés Mâles sur Monture

600

Hexagonal Corta
Short Hex • Hexagonale Courte



1,5 · 2 · 2,5 · 3 · 4 · 5 · 6 · 8 mm

Part N°	€
600-018	14,25

603

Hexagonal Redonda Corta
Short Ball Nose Hex
Hexagonale Courte Tête Sphérique



1,5 · 2 · 2,5 · 3 · 4 · 5 · 6 · 8 mm

Part N°	€
603-018	19,45

606

Torx Corta
Short Torx • Torx Courte



T9 · T10 · T15 · T20 · T25 · T27 · T30 · T40

Part N°	€
606-018	21,95

609

Torx Seguridad Corta
Short Torx Tamper • Torx Sécurité Courte



TS9 · TS10 · TS15 · TS20 · TS25 · TS27 · TS30 · TS40

Part N°	€
609-018	23,90

Llaves Macho • Key Wrenches • Clés Mâles

Llaves en "T" • T-Handles • Clés en "T"
618
Hexagonal Redonda

Ball Nose Hex • Hexagonale Tête Sphérique

S2

mm	L1 mm	Part N°	€
1,5	80	618-01,5	5,90
2	90	618-02	5,90
2,5	100	618-02,5	6,00
3	115	618-03	6,08
4	120	618-04	7,27
5	140	618-05	7,90
6	160	618-06	8,41
7	170	618-07	11,50
8	175	618-08	11,79
9	185	618-09	13,62
10	200	618-10	16,50
12	225	618-12	24,93

620
Torx Seguridad

Torx Tamper • Torx Sécurité

S2

mm	L1 mm	Part N°	€
9	90	620-TS09	6,96
10	100	620-TS10	6,96
15	115	620-TS15	7,13
20	120	620-TS20	7,20
25	130	620-TS25	8,54
27	140	620-TS27	8,75
30	150	620-TS30	8,77
40	160	620-TS40	9,29
45	175	620-TS45	9,90
50	200	620-TS50	16,00
55	225	620-TS55	19,98

Llaves en "T" • T-Handles • Clés Mâles en "T"

621

Vaso Hexagonal
Nut Driver • Douille Hexagonale



CrV



mm	L1 mm	Part N°	€
5	230	621-05	9,43
5,5	230	621-05,5	9,43
6	230	621-06	9,43
7	230	621-07	9,43
8	230	621-08	9,75
9	230	621-09	9,75
10	230	621-10	10,89
11	230	621-11	10,89
12	230	621-12	12,03
13	230	621-13	12,03
14	230	621-14	12,84

Juegos de Llaves en "T" • T-Handle Sets • Jeux de Clés en "T"

618

Bandeja Combinable
EVA Foam Tray • Panneau de Mousse Modulable

10
Pcs

S2



1/2 (375 x 280 X 30 mm)



2 • 2,5 • 3 • 4 • 5 • 6 • 7 • 8 • 10 • 12

Part N°	€
618-080	119,29

620

Bandeja Combinable
EVA Foam Tray • Panneau de Mousse Modulable

10
Pcs

S2

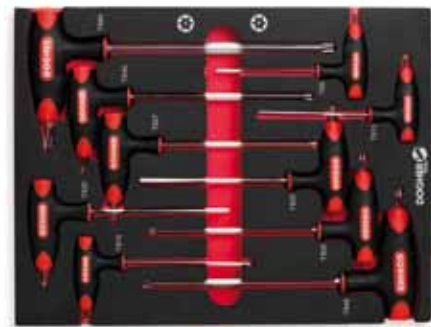

1/2 (375 x 280 X 30 mm)



TS9 • TS10 • TS15 • TS20 • TS25 • TS27 • TS30 • TS40 • TS45 • TS50

Part N°	€
620-080	102,49

Ver Información Ampliada sobre Almacenaje y Bandejas Combinables en Páginas:
Get Extended Information about Storage and EVA Foam Trays in Pages:
Voir pour Plus d'information sur le Rangement et Panneaux de Mousse Modulables Pages:

10 - 11

Llaves Macho • Key Wrenches • Clés Mâles

Expositores de Llaves en "T" • T-Handle Displays • Présentoirs de Clés en "T"

618

Hexagonal Redonda

Ball Nose Hex • Hexagonale Tête Sphérique

8

Pcs



215 x 50 x 270 mm



2 · 2,5 · 3 · 4 · 5 · 6 · 8 · 10 mm

Part N°	€
618-001	76,11

620

Torx Seguridad

Torx Tamper • Torx Sécurité

9

Pcs



215 x 50 x 270 mm



TS10 · TS15 · TS20 · TS25 · TS27 · TS30 · TS40 · TS45 · TS50

Part N°	€
620-001	88,79

621

Vaso Hexagonal

Nut Driver • Douille Hexagonale

6

Pcs



180 x 50 x 270 mm



6 · 8 · 10 · 12 · 13 · 14 mm

Part N°	€
621-001	73,29

Llaves Dinamométricas
Torque Wrenches
Clés Dynamométriques



3%		268
4%		269
9x12 mm		270
14x18 mm		271
3%		272
14x18 mm		272
1/4"		272
5%		273

Llaves Dinamométricas • Torque Wrenches • Clés Dynamométriques
Serie Profesional • Professional Series • Série Professionnelle

Incluye Manual de Instrucciones y Certificado
 Instruction Manual & Certificate Included • Inclut Manuel d'utilisation et Certificat

625
Llave Dinamométrica Profesional
 Professional Torque Wrench • Clé Dynamométrique Professionnelle

3%

1/4"



N*m	L mm		Accur.	Part N°	€
1~5	200	1/4"	3%	625-01-05	164,95
6~30	260	1/4"	3%	625-06-30	174,23

626
Llave Dinamométrica Profesional
 Professional Torque Wrench • Clé Dynamométrique Professionnelle

3%

3/8"



N*m	L mm		Accur.	Part N°	€
15~80	385	3/8"	3%	626-15-80	186,90
19~110	385	3/8"	3%	626-19-110	202,80

627
Llave Dinamométrica Profesional
 Professional Torque Wrench • Clé Dynamométrique Professionnelle

3%

1/2"



N*m	L mm		Accur.	Part N°	€
40~210	535	1/2"	3%	627-40-210	210,85
70~350	645	1/2"	3%	627-70-350	252,80

628
Llave Dinamométrica Profesional
 Professional Torque Wrench • Clé Dynamométrique Professionnelle

3%

3/4"



N*m	L mm		Accur.	Part N°	€
100~500	865	3/4"	3%	628-100-500	499,68
140~700	1090	3/4"	3%	628-140-700	836,13
140~980	1230	3/4"	3%	628-140-980	999,68

629
Llave Dinamométrica Profesional
 Professional Torque Wrench • Clé Dynamométrique Professionnelle

3%

1"



N*m	L mm		Accur.	Part N°	€
140~980	1230	1"	3%	629-140-980	1.005,58
300~1500	1740	1"	3%	629-300-1500	1.862,80

Serie **Standard** • **Standard** Series • Série **Standard**



Incluye Manual de Instrucciones y Certificado
Instruction Manual & Certificate Included • Inclut Manuel d'utilisation et Certificat

630

Llave Dinamométrica Estándar
Standard Torque Wrench • Clé Dynamométrique Standard

4%

1/4"



N*m	L mm		Accur.	Part N°	€
5~25	280	1/4"	4%	630-05-25	111,10

631

Llave Dinamométrica Estándar
Standard Torque Wrench • Clé Dynamométrique Standard

4%

3/8"



N*m	L mm		Accur.	Part N°	€
5~25	280	3/8"	4%	631-05-25	144,95
19~110	365	3/8"	4%	631-19-110	161,13

632

Llave Dinamométrica Estándar
Standard Torque Wrench • Clé Dynamométrique Standard

4%

1/2"



N*m	L mm		Accur.	Part N°	€
19~110	365	1/2"	4%	632-19-110	161,13
42~210	470	1/2"	4%	632-42-210	163,08
70~350	635	1/2"	4%	632-70-350	224,98

633

Llave Dinamométrica Estándar
Standard Torque Wrench • Clé Dynamométrique Standard

4%

3/4"



N*m	L mm		Accur.	Part N°	€
65~450	850	3/4"	4%	633-65-450	285,83
140~700	1065	3/4"	4%	633-140-700	697,45
140~980	1215	3/4"	4%	633-140-980	833,33

634

Llave Dinamométrica Estándar
Standard Torque Wrench • Clé Dynamométrique Standard

4%

1"



N*m	L mm		Accur.	Part N°	€
140~980	1215	1"	4%	634-140-980	914,68

Intercambiable y Cabezas de Repuesto • Interchangeable & Spare Heads • Intercchangeable et Têtes de Rechange

636

Llave Dinamométrica Intercambiable

Interchangeable Torque Wrench • Clé Dynamométrique Intercchangeable

3%



Incluye Manual de Instrucciones y Certificado
Instruction Manual & Certificate Included
Inclut Manuel d'utilisation et Certificat

9x12 mm



N*m	L mm		Accur.	Part N°	€
6~30	220	9x12	3%	636-06-30	169,68
20~110	220	9x12	3%	636-20-110	180,30

636

Cabeza Abierta

Open Ended Insert Tool • Embout à Fourche Plate

CrV

9x12 mm



mm		Part N°	€
7	9 x 12	636-07	28,68
8	9 x 12	636-08	28,68
9	9 x 12	636-09	28,68
10	9 x 12	636-10	28,68
11	9 x 12	636-11	28,68
12	9 x 12	636-12	28,68
13	9 x 12	636-13	28,68
14	9 x 12	636-14	28,68
15	9 x 12	636-15	28,68
16	9 x 12	636-16	28,68
17	9 x 12	636-17	28,68
18	9 x 12	636-18	28,68
19	9 x 12	636-19	28,68

636

Cabeza de Estrella

Ring Torque Insert Tool • Douille Bi-Hexagonale

CrV

9x12 mm



mm		Part N°	€
7	9 x 12	636-07X	28,68
8	9 x 12	636-08X	28,68
9	9 x 12	636-09X	28,68
10	9 x 12	636-10X	28,68
11	9 x 12	636-11X	28,68
12	9 x 12	636-12X	28,68
13	9 x 12	636-13X	28,68
14	9 x 12	636-14X	28,68
15	9 x 12	636-15X	28,68
16	9 x 12	636-16X	28,68
17	9 x 12	636-17X	28,68
18	9 x 12	636-18X	28,68
19	9 x 12	636-19X	28,68

636

Cabeza Llave Dinamométrica de Carraca

Torque Ratchet Head • Tête Clé Dynamométrique à Cliquet

9x12 mm



		Part N°	€
3/8"	9 x 12	636-3/8	30,58
1/2"	9 x 12	636-1/2	36,13

Intercambiable y Cabezas de Repuesto • Interchangeable & Spare Heads • Interchangeable et Têtes de Rechange

637

Llave Dinamométrica Intercambiable

Interchangeable Torque Wrench • Clé Dynamométrique Intercchangeable

3%



Incluye Manual de Instrucciones y Certificado
Instruction Manual & Certificate Included
Inclut Manuel d'utilisation et Certificat

14x18
mm



N*m	L mm	■	Accur.	Part N°	€
40~210	460	14x18	3%	637-40-210	215,30
70~350	525	14x18	3%	637-70-350	227,80

637

Cabeza Abierta

Open Ended Insert Tool • Embout à Fourche Plate

CrV

14x18
mm



mm	■	Part N°	€
13	14 x 18	637-13	35,76
14	14 x 18	637-14	35,76
15	14 x 18	637-15	35,76
16	14 x 18	637-16	35,76
17	14 x 18	637-17	35,76
18	14 x 18	637-18	35,76
19	14 x 18	637-19	35,76
21	14 x 18	637-21	35,76
22	14 x 18	637-22	35,76
24	14 x 18	637-24	35,76
27	14 x 18	637-27	35,76
30	14 x 18	637-30	35,76
32	14 x 18	637-32	35,76
34	14 x 18	637-34	39,12
36	14 x 18	637-36	39,12
38	14 x 18	637-38	39,12
41	14 x 18	637-41	39,12

637

Cabeza de Estrella

Ring Torque Insert Tool • Douille Bi-Hexagonale

CrV

14x18
mm



mm	■	Part N°	€
13	14 x 18	637-13X	35,76
14	14 x 18	637-14X	35,76
15	14 x 18	637-15X	35,76
16	14 x 18	637-16X	35,76
17	14 x 18	637-17X	35,76
18	14 x 18	637-18X	35,76
19	14 x 18	637-19X	35,76
21	14 x 18	637-21X	35,76
22	14 x 18	637-22X	35,76
24	14 x 18	637-24X	35,76
27	14 x 18	637-27X	35,76
30	14 x 18	637-30X	35,76
32	14 x 18	637-32X	35,76
34	14 x 18	637-34X	39,12
36	14 x 18	637-36X	39,12
41	14 x 18	637-41X	39,12

637

Cabeza Llave Dinamométrica de Carraca

Torque Ratchet Head • Tête Clé Dynamométrique à Cliquet

14x18
mm



■	■	Part N°	€
3/8"	14 x 18	637-3/8	36,13
1/2"	14 x 18	637-1/2	41,68

Llaves Dinamométricas • Torque Wrenches • Clés Dynamométriques

Llave Flexible e Intercambiable • Flexible & Interchangeable • Clé Flexible et Intchangeable



Incluye Manual de Instrucciones y Certificado
Instruction Manual & Certificate Included • Inclut Manuel d'utilisation et Certificat

635

Llave Dinamométrica Flexible
Flexible Torque Wrench • Clé Dynamométrique Flexible

3%



N*m	L mm	□	Accur.	Part N°	€
40~210	515	1/2"	3%	635-40-210	308,35

640

Estuche de Llaves Dinamométricas Intercambiables
Interchangeable Torque Wrenches Set • Coffret de Clés Dynamométriques Intchangeables

11

Pcs

3%



40~210 Nm

13 · 14 · 15 · 17 · 19 · 22 · 24 · 27 · 30 mm

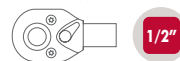

1/2"

N*m	L mm	□	Accur.	Part N°	€
40~210	510	14x18	3%	640-001	503,08

Destornilladores Dinamométricos • Torque Screwdrivers • Tournevis Dynamométriques

642

Destornillador Dinamométrico con Cuadrado
Torque Screwdriver Square Drive • Tournevis Dynamométrique avec Carré d'entraînement

1/4"

6%



□	L mm	N*m	Accur.	Part N°	€
1/4"	135	0,4~2	6%	642-0,4-2	163,93

643

Destornillador Dinamométrico Portapuntas
Torque Screwdriver Bit Holder • Tournevis Dynamométrique Porte-embouts de Vissage

1/4"

6%



□	L mm	N*m	Accur.	Part N°	€
1/4"	135	0,4~2	6%	643-0,4-2	163,93

Juegos de Multiplicadores de Par • Torque Multiplier in Carrying Sets • Jeux de Multiplicateur de Couple

645

Multiplicador de Par en Maletín

Torque Multiplier in Carrying Case • Coffret de Multiplicateur de Couple

5%

- Incluye Pie de reacción, Barra Soporte y Varilla Desbloqueo
Includes Cranked Reaction bar, Straight Reaction bar and Release kit
Inclut Pied de réaction, Barre de Support et Tige de Débloqueo



IN	OUT	Accur.	● : ●	IN (Max) Nm	OUT (Max) Nm	Part N°	€
1/2"	3/4"	5 %	1 : 3	500	1500	645-001	757,45

645

Multiplicador de Par en Maletín

Torque Multiplier in Carrying Case • Coffret de Multiplicateur de Couple

5%

- Incluye Pie de reacción, Barra Soporte y Varilla Desbloqueo
Includes Cranked Reaction bar, Straight Reaction bar and Release kit
Inclut Pied de réaction, Barre de Support et Tige de Débloqueo



IN	OUT	Accur.	● : ●	IN (Max) Nm	OUT (Max) Nm	Part N°	€
3/4"	1"	5 %	1 : 3	1000	3000	645-002	830,58

645

Multiplicador de Par en Maletín con Sistema Anti-sobrecarga

Torque Multiplier with Anti-overload System in Carrying Case • Coffret de Multiplicateur de Couple avec Sécurité de Surcharge

5%

- Incluye Pie de reacción, Barra Soporte y 1 Repuesto Anti-sobrecarga
Includes Straight Reaction bar, 90° Reaction bar and 1 Breakaway Input Adaptor
Inclut Pied de réaction, Barre de Support et 1 Rechange Sécurité Surcharge



IN	OUT	Accur.	● : ●	IN (Max) Nm	OUT (Max) Nm	Part N°	€
1/2"	3/4"	5 %	1 : 6,5	231	1500	645-004	897,75

Juegos de Multiplicadores de Par • Torque Multiplier in Carrying Sets • Jeux de Multiplicateur de Couple

645

Multiplicador de Par en Maletín con Sistema Anti-sobrecarga

Torque Multiplier with Anti-overload System in Carrying Case • Coffret de Multiplicateur de Couple avec Sécurité de Surcharge

5%

- Incluye Pie de reacción, Barra Soporte y 1 Repuesto Anti-sobrecarga
Includes Straight Reaction bar, 90° Reaction bar and 1 Breakaway Input Adaptor
Inclut Pied de réaction, Barre de Support et 1 Rechange Sécurité Surcharge



IN	OUT	Accur.	Ratio	IN (Max) Nm	OUT (Max) Nm	Part N°	€
1/2"	1"	5 %	1 : 12	208	2300	645-005	1.040,88

645

Multiplicador de Par en Maletín Especial para Ruedas de Camiones

Special Torque Multiplier for Truck Wheel Nuts Case • Coffret de Multiplicateur de Couple Spécial pour Roues de Camions

5%

- Incluye Dos vasos 32mm y 33mm, Manivela y Alargador
Includes 32mm and 33mm sockets, Handle and Extension bar
Inclut Deux douilles 32mm et 33mm, Manivelle et Rallonge







- Pie de Reacción Integrado en el Cuerpo del Multiplicador
The Cranked Reaction bar is Integrated in the Body of the Tool
Pied de Réaction inclus dans le corps du Multiplicateur

IN	OUT	Accur.	Ratio	OUT (Max) Nm	Part N°	€
1"	1"	5 %	1 : 56	3200	645-003	585,00





		276	
		276	
		278	
		278	
		278	
		279	
		280	
			281
			281

Llaves Stillson • Spanish Type Pipe Wrenches • Clés Stillson
650
Llave Stillson Forjada Profesional

Professional Spanish Type Pipe Wrench • Clé Stillson Professionnelle en Acier Forgé

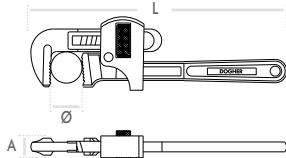
CrV
60HRC

L mm	L "	Ø mm	Ø "	A mm	Part N°	€
200	8	25	1	11	650-200	17,78
250	10	35	1. 3/8	15	650-250	25,13
300	12	44	1. 3/4	17	650-300	28,91
350	14	50	2	19	650-350	31,95
450	18	60	2. 3/8	23	650-450	43,19
600	24	76	3	26	650-600	68,05
900	36	102	4	30	650-900	149,43

655
Llave Stillson Aluminio Profesional

Professional Aluminium Pipe Wrench • Clé Stillson Légère Professionnelle

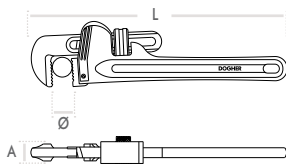
CrV
60HRC

L mm	L "	Ø mm	Ø "	A mm	Part N°	€
250	10	49	1. 1/2	17	655-250	33,91
350	14	60	2	21	655-350	47,86
450	18	76	2. 1/2	26	655-450	71,46
600	24	89	3	28	655-600	93,52
900	36	140	5	32	655-900	186,39

Repuestos para Llaves Stillson • Spanish Type Pipe Wrench Spare Parts • Rechanges pour Clés Stillson

651

Repuesto Boca Móvil
Spare moving Jaw • Mors Mobile en Acier Forgé

CrV

Apta para • Suitable for • Apte pour
650



L mm	L "	Part N°	€
200	8	651-200	10,67
250	10	651-250	15,08
300	12	651-300	17,34
350	14	651-350	19,43
450	18	651-450	21,60
600	24	651-600	34,02
900	36	651-900	67,09

652

Tuerca de Repuesto
Spare Nut • Bague de Serrage

CrV

Apta para • Suitable for • Apte pour
650



L mm	L "	Part N°	€
200	8	652-200	7,11
250	10	652-250	7,54
300	12	652-300	8,67
350	14	652-350	9,43
450	18	652-450	10,30
600	24	652-600	13,61
900	36	652-900	25,16

656

Repuesto Boca Móvil
Spare moving Jaw • Mors Mobile

CrV

Apta para • Suitable for • Apte pour
655



L mm	L "	Part N°	€
250	10	656-250	16,59
350	14	656-350	21,37
450	18	656-450	23,76
600	24	656-600	37,43
900	36	656-900	73,80

658

Tuerca de Repuesto
Spare Nut • Bague de Serrage

CrV

Apta para • Suitable for • Apte pour
655



L mm	L "	Part N°	€
350	14	658-350	9,43
450	18	658-450	10,30
600	24	658-600	13,61
900	36	658-900	25,16

657

Repuesto Boca Fija
Spare fixed Jaw • Mors Fixe

CrV

Apta para • Suitable for • Apte pour
655



L mm	L "	Part N°	€
350	14	657-350	19,23
450	18	657-450	21,38
600	24	657-600	29,94
900	36	657-900	59,04

Llaves para Tubo • Pipe Wrenches • Clés Serre-Tubes
660
Llave para Tubo Combinada Profesional

Professional S Type Bent Nose Pipe Wrench • Clé Serre-Tubes en "S" Professionnelle

CrV

60HRC



L mm	Ø mm	Ø "	Part N°	€
320	25	1	660-320	28,35
425	38	1. 1/2	660-425	37,69
550	50	2	660-550	59,92
630	75	3	660-630	88,22

661
Llave para Tubo Boca Recta Profesional

Professional 90 Degree Straight Nose Pipe Wrench • Clé Serre-Tubes 90° Professionnelle

CrV

60HRC



L mm	Ø mm	Ø "	Part N°	€
320	25	1	661-320	27,22
425	38	1. 1/2	661-425	36,18
550	50	2	661-550	57,53
630	75	3	661-630	84,70

662
Llave de Cadena Profesional

Professional Chain Pipe Wrench • Clé à Chaîne Professionnelle

CrV



L mm	Ø mm	Part N°	€
300	90	662-001	39,54

662
Llave de Cinta Profesional

Professional Belt Pipe Wrench • Clé à Sangle Professionnelle

CrV



L mm	Ø mm	Part N°	€
75	20	662-002	39,27
200	60	662-003	49,82

Repuestos para Llaves para Tubo • Pipe Wrench Spare Parts • Clés Serre-Tubes de Rechange

662

Cadena de Repuesto
Spare Chain • Chaîne de Rechange

Apta para • Suitable for • Apte pour
662-001



L mm	Part N°	€
300	662-001R	15,77

662

Cinta de Repuesto
Spare Belt • Sangle de Rechange

Apta para • Suitable for • Apte pour
662-002 / 662-003



L mm	Part N°	€
75	662-002R	15,01
200	662-003R	18,87

Cortatubos • Tube Cutter • Coupe-Tubes

665

Cortatubos para PVC Retroceso Automático
PVC Pipe Cutter Automatic Return • Coupe-Tubes PVC Retour Automatique



Ø mm
0~45



Ø mm	Part N°	€
0~45	665-45	57,80

• Incluye Soporte de Plástico para Corte de Superficies Planas
Includes Plastic Accessory for Flat Surfaces Cutting
Inclut Support Plastique pour la Coupe de Surface Plane

667

Cortatubos para PVC Retroceso Manual
PVC Pipe Cutter Manual Return • Coupe-Tubes PVC Retour Manuel



Ø mm
0~36



Ø mm	Part N°	€
0~36	667-36	30,75

Cortatubos • Tube Cutter • Coupe-Tubes

675

Cortatubos Regulable para Metal
Zip Action Tube Cutter • Coupe-Tubes Réglable pour le Métal

Cu

Al

Inox



Ø mm	Part N°	€
3~28	675-03-28	22,75

• Incluye Cuchilla de Recambio
Includes Spare Blade · Inclut une Lame de Rechange

675

Cortatubos Regulable para Metal
Zip Action Tube Cutter • Coupe-Tubes Réglable pour le Métal

Cu

Al

Inox



Ø mm	Part N°	€
3~32	675-03-32	19,45

• Incluye Rebarbador
Includes Deburring Tool · Inclut un Ebavureur

675

Cortatubos Regulable para Metal
Zip Action Tube Cutter • Coupe-Tubes Réglable pour le Métal

Cu

Al

Inox



Ø mm	Part N°	€
3~41	675-03-41	36,69

• Incluye Cuchilla de Recambio
Includes Spare Blade · Inclut une Lame de Rechange

675

Cortatubos Regulable para Metal
Zip Action Tube Cutter • Coupe-Tubes Réglable pour le Métal

Cu

Al

Inox



Ø mm	Part N°	€
6~65	675-06-65	77,28

• Incluye Rebarbador y Cuchilla de Recambio
Includes Deburring Tool and Spare Blade
Inclut un Ebavureur et une Lame de Rechange

Cortatubos • Tube Cutter • Coupe-Tubes

675

Mini Cortatubos Regulable para Metal

Mini Zip Action Tube Cutter • Mini Coupe-Tube Réglable pour le Métal

Cu

Al

Inox



Ø mm	Part N°	€
3~16	675-03-16	11,61

676

Cortatubos Automático para Metal con Cuerpo de Zinc

Auto Tube Cutter Zinc Body • Coupe-Tubes Automatique pour Métal avec Corps en Zinc

Cu

Al

Inox



Ø mm	Part N°	€
10	676-10	21,83
12	676-12	22,60
15	676-15	24,90
22	676-22	26,95

677

Avellanador para Tubos

Pipe Deburring Countersink • Alésoir Intérieur et Extérieur pour Tubes

Cu

Al

Inox



Int.

Ext.

Ø mm	Part N°	€
3~40	677-03-40	15,98

Repuestos para Cortatubos • Tube cutter Spare Parts • Rechanges pour Coupe-Tubes
665
Cuchilla de Repuesto
 Spare Blade • Lame de Rechange

 Apta para • Suitable for • Apte pour
 665-45

Ø mm	Part N°	€
0~45	665-45R	14,00

667
Cuchilla de Repuesto
 Spare Blade • Lame de Rechange

 Apta para • Suitable for • Apte pour
 667-36

Ø mm	Part N°	€
0~36	667-36R	8,00

675
Cuchilla de Repuesto
 Spare Blade • Lame de Rechange

 Apta para • Suitable for • Apte pour
 675-03-28 / 675-03-32 / 675-03-41

Material • Matériel	Aplicación • Application	Part N°	€
Acero Carbono Carbon Steel • Acier au Carbone	Cu • Al • Bronce • Bronze	675-04AC	2,00
HSS	Inox	675-04HSS	4,73

675
Cuchilla de Repuesto
 Spare Blade • Lame de Rechange

 Apta para • Suitable for • Apte pour
 675-06-65

Material • Matériel	Aplicación • Application	Part N°	€
Acero Carbono Carbon Steel • Acier au Carbone	Cu • Al • Bronce • Bronze	675-06-65AC	6,50
HSS	Inox	675-06-65HSS	12,18

675
Cuchilla de Repuesto
 Spare Blade • Lame de Rechange

 Apta para • Suitable for • Apte pour
 675-03-16

Material • Matériel	Aplicación • Application	Part N°	€
Acero Carbono Carbon Steel • Acier au Carbone	Cu • Al • Bronce • Bronze	675-03-16AC	1,75



		284
		284
		285
		285
		286
		286
		287
		289
		289
		292
		294
		295

Percusión • Percussion • Frappe et Martellerie

Martillos de Bola • Ball Pen Hammers • Marteaux Mécanicien Tête Boule
700
Mango Hickory
 Hickory Handle • Manche Hickory

701
Mango Fibra de Vidrio
 Fiberglass Handle • Manche Fibre de Verre

	g	A mm	L mm	Part N°	€
B	340	28	315	700-340	11,95
C	455	30	350	700-455	14,45
D	560	32	350	700-560	16,70
E	680	34	360	700-680	18,50
F	910	38	390	700-910	20,03
G	1130	40	420	700-1130	22,23
H	1360	40	420	700-1360	23,85

	g	A mm	L mm	Part N°	€
C	455	30	310	701-455	19,86
D	560	32	310	701-560	21,67
E	680	34	330	701-680	23,65
F	910	38	365	701-910	27,76
H	1360	40	400	701-1360	36,68

Martillos de Peña • Carpenter Hammers • Marteaux Menuisier
702
Mango Hickory
 Hickory Handle • Manche Hickory

703
Mango Fibra de Vidrio
 Fiberglass Handle • Manche Fibre de Verre

	g	A mm	L mm	Part N°	€
100	18	270	702-100	8,25	
135	20	270	702-135	9,18	
180	22	290	702-180	9,98	
320	25	290	702-320	10,58	
420	30	300	702-420	12,48	

	g	A mm	L mm	Part N°	€
100	18	270	703-100	11,70	
135	20	270	703-135	12,18	
180	22	270	703-180	12,48	
320	25	270	703-320	12,53	
420	30	300	703-420	14,95	

Macetas de Albañil • Spanish Stone Hammers • Massettes de Maçon

704

Mango Hickory
Hickory Handle • Manche Hickory



g	L mm	Part N°	€
1000	260	704-1000	19,13
1250	260	704-1250	21,63

705

Mango Fibra de Vidrio
Fiberglass Handle • Manche Fibre de Verre



g	L mm	Part N°	€
1000	260	705-1000	22,28
1250	260	705-1250	24,78

Martillos de Uña Curva • Carpentry Hammers • Marteaux de Charpentier

708

Mango Hickory
Hickory Handle • Manche Hickory



g	L mm	Part N°	€
400	370	708-400	12,85
600	370	708-600	14,73
800	370	708-800	16,13

Percusión • Percussion • Frappe et Martellerie

Martillos de Encofrador • Shuttering Hammers • Marteaux de Charpentier

710

Mango Hickory
Hickory Handle • Manche Hickory



g	L mm	Part N°	€
500	370	710-500	19,45
700	370	710-700	20,28

711

Mango Fibra de Vidrio
Fiberglass Handle • Manche Fibre de Verre



g	L mm	Part N°	€
700	370	711-700	26,28

Mazas • Big Head Sledge Hammers • Masses

712

Mango Hickory
Hickory Handle • Manche Hickory



g	L mm	Part N°	€
3000	900	712-3000	47,23
5000	900	712-5000	77,80

713

Mango Fibra de Vidrio
Fiberglass Handle • Manche Fibre de Verre



g	L mm	Part N°	€
3000	900	713-3000	41,88
4000	900	713-4000	64,40
5000	900	713-5000	72,45

Maza Cuña • Sledge Hammer • Masse-Hache

726

Mango Fibra de Vidrio
Fiberglass Handle • Manche Fibre de Verre



g	L mm	Part N°	€
3000	950	726-3000	68,38

Piquetas de Albañil • Hammer Shovel Picks • Marteaux de Maçon

714

Mango Hickory
Hickory Handle • Manche Hickory



g	L mm	Part N°	€
700	330	714-700	24,73

715

Mango Fibra de Vidrio
Fiberglass Handle • Manche Fibre de Verre



g	L mm	Part N°	€
700	370	715-700	30,58

Percusión • Percussion • Frappe et Martellerie

Alcotanas Pala-Hacha • Axe Shovel Picks • Décintroids Pelle-Hache

716

Mango Hickory

Hickory Handle • Manche Hickory

717

Mango Fibra de Vidrio

Fiberglass Handle • Manche Fibre de Verre



g	L mm	Part N°	€
550	330	716-550	21,35
650	370	716-650	25,03

g	L mm	Part N°	€
550	370	717-550	24,68
650	370	717-650	27,90

Alcotanas Pala-Pico • Spike Shovel Picks • Décintroids Pelle-Pioche

718

Mango Hickory

Hickory Handle • Manche Hickory

719

Mango Fibra de Vidrio

Fiberglass Handle • Manche Fibre de Verre



g	L mm	Part N°	€
400	330	718-400	23,00
650	330	718-650	25,78

g	L mm	Part N°	€
400	330	719-400	28,08
650	330	719-650	30,85

Hacha • Axe • Hache

724

Mango Hickory
Hickory Handle • Manche Hickory



g	L mm	Part N°	€
500	450	724-500	22,37
700	450	724-700	24,21
1000	680	724-1000	32,96

Pico • Pick • Pioche

721

Cabeza de Pico
Pick Head • Tête pour Pioche



g	Part N°	€
2500	721-2500	33,03
3000	721-3000	36,93

722H

Mango Hickory para Pico
Hickory Spare Handle
Manche Hickory pour Pioche



L mm	Part N°	€
900	722H-900	15,00

723H

Mango Fibra de Vidrio para Pico
Fiberglass Spare Handle
Manche Fibre de Verre pour Pioche



L mm	Part N°	€
900	723H-900	22,50

Repuestos • Spare Parts • Rechanges

704H

Mango Hickory para Maceta de Albañil
Spanish Stone Hammer Hickory Handle
Manche Hickory pour Massette de Maçon

Apta para • Suitable for • Apte pour
704



L mm	Part N°	€
260	704H-260	5,00

705H

Mango Fibra de Vidrio para Maceta de Albañil
Spanish Stone Hammer Fiberglass Handle
Manche Fibre de Verre pour Massette de Maçon

Apta para • Suitable for • Apte pour
705



L mm	Part N°	€
260	705H-260	8,15

708H

Mango Hickory para Martillo de Uña Curva
Carpentry Hammer Hickory Handle
Manche Hickory pour Marteau de Charpentier

Apta para • Suitable for • Apte pour
708



L mm	Part N°	€
370	708H-370	5,00

709H

Mango Fibra de Vidrio para Martillo Uña Curva
Claw Hammer Fiberglass Handle
Manche Fibre de Verre pour Marteau de Charpentier

Apta para • Suitable for • Apte pour
709



L mm	Part N°	€
370	709H-370	11,33

Repuestos • Spare Parts • Rechanges

710H

Mango Hickory para Martillo de Encofrador
Shuttering Hammer Hickory Handle
Manche Hickory pour Marteau de Charpentier

Apta para • Suitable for • Apte pour
710



L mm	Part N°	€
370	710H-370	5,00

711H

Mango Fibra de Vidrio para Martillo Encofrador
Shuttering Hammer Fiberglass Handle
Manche Fibre de Verre pour Marteau de Charpentier

Apta para • Suitable for • Apte pour
711



L mm	Part N°	€
370	711H-370	11,00

712H

Mango Hickory para Maza
Big Head Sledge Hammer Hickory Handle
Manche Hickory pour Masse

Apta para • Suitable for • Apte pour
712



L mm	Part N°	€
900	712H-900	22,85

713H

Mango Fibra de Vidrio para Maza
Big Head Sledge Hammer Fiberglass Handle
Manche Fibre de Verre pour Masse

Apta para • Suitable for • Apte pour
713



L mm	Part N°	€
900	713H-900	17,50

Martillos de Bocas de Nylon • Rubber Hammers • Marteaux à Têtes de Nylon
730
Mango Metálico

Metal Handle • Manche Métal



Ø mm	L mm	Part N°	€
25	250	730-25	16,95
30	250	730-30	17,63
35	260	730-35	23,03
40	295	730-40	29,98
45	295	730-45	33,03

731
Mango Hickory

Hickory Handle • Manche Hickory



Ø mm	L mm	Part N°	€
25	250	731-25	11,40
30	250	731-30	12,23
35	260	731-35	15,53
40	280	731-40	19,73
45	280	731-45	22,48

733
Antirrebote con Mango Hickory

Hickory Handle Dead Blow • Sans Rebond avec Manche Hickory



Ø mm	L mm	Part N°	€
25	260	733-25	17,65
30	260	733-30	21,98
35	260	733-35	25,23
40	290	733-40	39,18
50	290	733-50	44,03
60	290	733-60	52,80

Repuestos • Spare Parts • Rechanges

732

Bocas de Nylon de Recambio
Rubber Spare Head • Têtes de Nylon de Rechange

Apta para • Suitable for • Apte pour
730 / 731



Ø mm	Part N°	€
25	732-25	1,55
30	732-30	1,93
35	732-35	2,50
40	732-40	3,25
45	732-45	3,53

734

Bocas de Nylon de Recambio
Rubber Spare Head • Têtes de Nylon de Rechange

Apta para • Suitable for • Apte pour
733



Ø mm	Part N°	€
25	734-25	2,40
30	734-30	3,46
35	734-35	4,06
40	734-40	6,45
50	734-50	6,90
60	734-60	7,80

Mazas Integrales de Poliuretano • Solid Polyurethane Sledge Hammers • Massettes Polyuréthanes Monoblocs

735

Antirrebote
Dead Blow • Sans Rebond



g	Ø mm	L mm	Part N°	€
450	40	235	735-450	16,25
620	40	240	735-620	19,43
800	45	250	735-800	21,38
920	50	250	735-920	23,35
1100	55	285	735-1100	24,48
1350	60	290	735-1350	24,98
1800	65	300	735-1800	31,13
2200	70	310	735-2200	42,48

739

Mango Bimaterial
Bimaterial • Bi-Matériel



g	Ø mm	L mm	Part N°	€
225	45	220	739-225	9,18
340	50	220	739-340	12,53
455	55	250	739-455	16,00
685	60	270	739-685	18,90
920	65	270	739-920	22,53

Percusión • Percussion • Frappe et Martellerie

Mazas de Goma • Rubber Hammers • Maillets Caoutchouc

736 Mango Hickory
Hickory Handle • Manche Hickory



g	Ø mm	L mm	Part N°	€
225	45	320	736-225	6,95
340	50	320	736-340	7,48
455	55	320	736-455	7,80
685	60	330	736-685	10,38
920	65	330	736-920	12,63

737 Mango Hickory para Solador
Hickory Handle Tile Layer • Caoutchouc Antimarque avec Manche Hickory



g	Ø mm	L mm	Part N°	€
225	43	320	737-225	9,73
340	47	320	737-340	10,63
455	57	320	737-455	11,68
685	67	330	737-685	13,88
920	70	330	737-920	16,40

738 Combinada con Mango Hickory
Mixed Rubber Hamme • Mixte avec Manche Hickory



g	Ø mm	L mm	Part N°	€
225	45	320	738-225	9,47
340	50	320	738-340	10,35
455	55	320	738-455	12,87
685	60	330	738-685	14,29
920	65	330	738-920	18,07

Granetes y Botadores • Centre Punches & Drift Punches • Pointeaux et Chasses-Goupilles

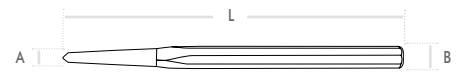

749 Granete Hexagonal
Hex Centre Punch • Pointeau Hexagonal

CrV



A mm	Hex mm	L mm	Part N°	€
2	10	100	749-02-10	4,95
3	10	100	749-03-10	4,95
4	10	120	749-04-10	4,95
5	12	120	749-05-12	5,76
6	12	120	749-06-12	6,05
8	12	120	749-08-12	6,28

744 Granete con Protector
Sheathed Centre Punch • Pointeau avec Protecteur

CrV



A mm	B mm	L mm	Part N°	€
4	10	175	744-04-10	8,00
6	10	175	744-06-10	8,00

746 Botador Cilíndrico
Standard Drift Punch • Chasse-Goupilles Standard

CrV



A mm	Hex mm	L mm	Part N°	€
2	10	150	746-02-10	4,55
3	10	150	746-03-10	4,59
4	10	150	746-04-10	4,64
5	10	150	746-05-10	5,33
6	10	150	746-06-10	5,75
7	12	150	746-07-12	5,75
8	12	150	746-08-12	5,81
10	12	150	746-10-12	5,81

745 Botador Cilíndrico con Protector
Sheathed Drift Punch • Chasse-Goupilles avec Protecteur

CrV



A mm	B mm	L mm	Part N°	€
2	10	165	745-02-10	8,69
3	10	175	745-03-10	8,69
4	10	185	745-04-10	8,69
5	10	200	745-05-10	8,69
6	10	200	745-06-10	8,69
8	10	200	745-08-10	8,69

Granetes y Botadores • Centre Punches & Drift Punches • Pointeaux et Chasses-Goupilles

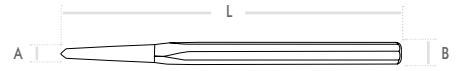

747 Botador Cilíndrico Serie Larga
Long Drift Punch • Chasse-Goupilles Long



A mm	Hex mm	L mm	Part N°	€
4	10	180	747-04-10	8,16
6	10	180	747-06-10	8,16

748 Botador Cónico
Standard Nail Punch • Chasse-Clous Standard



A mm	Hex mm	L mm	Part N°	€
1	10	120	748-01-10	4,55
2	10	120	748-02-10	4,55
3	10	120	748-03-10	4,55
4	10	120	748-04-10	4,55
5	10	120	748-05-10	4,55
6	10	120	748-06-10	5,70
8	10	120	748-08-10	5,74

750 Granete Automático
Automatic Centre Punch • Pointeau Automatique



Part N°	€
750-001	24,68

750 Puntas de Recambio para Granete Automático
Spare Points for Automatic Centre Punch • Pointes de Rechange pour Pointeau Automatique



Part N°	€
750-002	2,90

Juegos de Botadores • Punches Sets • Jeux de Pointeaux

746

Botadores Cilíndricos
Standard Drift Punches
Chasses-Goupilles Standards

6

Pcs

150
mm



 Ø 3x10 • 4x10 • 5x10 • 6x10 • 7x12 • 8x12 mm

Part N°	€
746-001	36,39

746

Botadores Cónicos y Granete Hexagonal
Standard Nail Punches and Centre Punch
Chasses-Clois Standards et Pointeau Hexagonal

6

Pcs

120
mm



 Ø 4x10 mm

 Ø 1x10 • 2x10 • 3x10 • 4x10 • 5x10 mm

Part N°	€
746-002	28,84

Cinceles • Chisels • Burins

755

Cinzel para Electricista
Electrician Chisel • Burin d'électricien

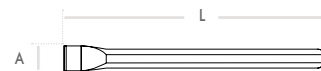

CrV



A mm	mm	L mm	Part N°	€
12	10	200	755-12-10-200	6,08
12	10	250	755-12-10-250	6,99
12	10	300	755-12-10-300	7,84

Punteros y Cinceles • Points & Chisels • Pointerolles et Burins

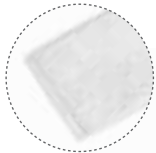
753
Cinzel
Flat Chisel • Burin Plat
CrV

A mm	mm	L mm	Part N°	€
22	16	250	753-22-16-250	12,08
22	16	300	753-22-16-300	14,86
25	19	350	753-25-19-350	16,96
25	19	400	753-25-19-400	21,10

751
Cinzel con Protector
Sheathed Chisel • Burin avec Protecteur
CrV

A mm	mm	L mm	Part N°	€
22	16	250	751-22-16-250	17,08
22	16	300	751-22-16-300	19,86
25	16	350	751-25-16-350	21,96
25	16	400	751-25-16-400	26,10

754
Puntero
Point • Pointerolle
CrV

A mm	mm	L mm	Part N°	€
4	16	250	754-04-16-250	11,16
4	16	300	754-04-16-300	13,83
4	19	350	754-04-19-350	14,86
4	19	400	754-04-19-400	24,23

752
Puntero con Protector
Sheathed Point • Pointerolle avec Protecteur
CrV

A mm	mm	L mm	Part N°	€
4	16	250	752-04-16-250	16,16
4	16	300	752-04-16-300	18,83
4	16	350	752-04-16-350	19,86
4	16	400	752-04-16-400	29,23

Cinceles • Chisels • Burins

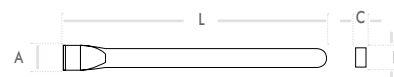

757

Cortafríos
Cold Chisel • Burin

CrV

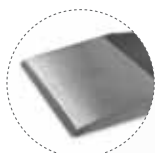

A mm	B x C mm	L mm	Part N°	€
30	23 x 13	200	757-30-23-200	10,76
30	23 x 13	250	757-30-23-250	12,57
30	23 x 13	300	757-30-23-300	13,71
30	23 x 13	350	757-30-23-350	15,75
30	23 x 13	400	757-30-23-400	17,70

756

Cortafríos con Protector
Sheathed Cold Chisel • Burin avec Protecteur

CrV

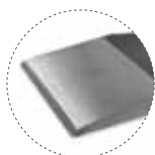

A mm	B x C mm	L mm	Part N°	€
30	23 x 13	250	756-30-23-250	17,57
30	23 x 13	300	756-30-23-300	18,71
30	23 x 13	350	756-30-23-350	20,75
30	23 x 13	400	756-30-23-400	22,70

758

Cinzel para Ranuras
Extra Wide Flat Chisel • Burin Extra Large

CrV

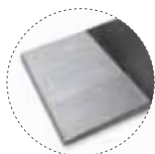

A mm	B x C mm	L mm	Part N°	€
50	23 x 13	250	758-50-23-250	18,99
70	23 x 13	250	758-70-23-250	20,86

759

Cinzel para Ranuras con Protector
Sheathed Extra Wide Flat Chisel • Burin Extra Large avec Protecteur

CrV

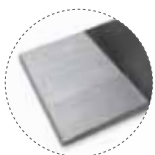

A mm	B x C mm	L mm	Part N°	€
50	23 x 13	250	759-50-23-250	23,99
70	23 x 13	250	759-70-23-250	25,86

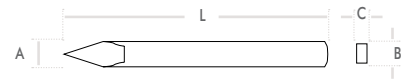
Buriles • Gravers • Bédanes

761
Buril
Graver • Bédane
CrV











B mm	C mm	L mm	Part N°	€
23	13	200	761-23-13-200	13,10
23	13	250	761-23-13-250	14,93

762
Buril con Protector
Sheathed Graver • Bédane avec Protecteur
CrV

B mm	C mm	L mm	Part N°	€
23	13	200	762-23-13-200	18,10
23	13	250	762-23-13-250	19,93

756
Protector Bimaterial
Bimaterial Sheath • Protecteur Bi-Matière
Apta para • Suitable for • Apte pour
756 - 759 - 762

B mm	C mm	L mm	Part N°	€
23	13	160	756-160	8,14

	302
	303
 	305
 	306
 	308
 	310



Medidor Láser • Laser Distance Meter • Télémètre Laser

781

Medidor Láser

Laser Distance Meter • Télémètre Laser

70m



Incluye Manual de Instrucciones y Certificado
Instruction Manual & Certificate Included
Inclut Manuel d'utilisation et Certificat



- Pestaña Abatible para la Medición sobre Esquinas
Extendable Pintail for Corner Measuring
Languette Rabattable pour Mesurer depuis un Angle



m	Part N°	€
0,05 ~ 70	781-70	270,00



- Área y Volumen
Area and Volume
Surface et Volume



- Suma y Resta
Addition and Subtraction
Addition et Soustraction



- Medición Indirecta
Indirect Measuring
Mesure Indirecte



- 20 Memorias
20 Memories
20 Mémoires



- Medida Cuenta Atrás
Countdown Measuring
Mesure avec Compte à Rebours



- Unidades de Medida
Measurement Unit
Unités de Mesure

- Medición Jalonada
Stake-out
Fonction d'implantation



- Funda
Carrying Case · Housse

- Correa de Seguridad
Safety Strap · Dragonne

- Medidor Láser
Distance Meter · Télémètre Laser

- Lápiz
Engineering Pencil · Stylet

- Protector de Silicona
Silica-gel Protector · Protecteur en Silicone

- Pílas
AA Batteries · Piles

Niveles • Levels • Niveaux

783

Nivel Tubular 3 Fioles
3 Vial Spirit Level • Niveau Tubulaire 3 Fioles

AI



L mm	Part N°	€
400	783-01-400	29,65
600	783-01-600	35,59
800	783-01-800	41,31
1000	783-01-1000	48,78
1200	783-01-1200	54,98

- 3 Fioles · Vial · Fioles • 45° · 90° · 180°
- Protección Antichoque · Shockproof Protection · Protection Antichoc
- Base en "V" = Colocación sobre Tubos
V-shape Base for Tube Surface
Base en "V" = Utilisation sur Tubes

783

Nivel Tubular Magnético 3 Fioles
3 Vial Magnetic Spirit Level • Niveau Tubulaire Magnétique 3 Fioles

AI



L mm	Part N°	€
400	783-02-400	17,56
600	783-02-600	21,71
800	783-02-800	24,98

- 3 Fioles · Vial · Fioles • 45° · 90° · 180°

784

Nivel Trapezoidal Magnético 2 Fioles
2 Vial Magnetic Trapezoid Spirit Level • Niveau Trapézoïdal Magnétique 2 Fioles

AI



L mm	Part N°	€
400	784-01-400	15,03
600	784-01-600	19,53

- 2 Fioles · Vial · Fioles • 90° · 180°

Niveles • Levels • Niveaux

785 Nivel Torpedo Tubular 2 Fioles
2 Vial Torpedo Level • Niveau Torpedo Tubulaire 2 Fioles



L mm	Part N°	€
250	785-001	19,00

- 2 Fioles · Vial · Fioles • 90° · 180°
- Protección Antichoque · Shockproof Protection · Protection Antichoc
- Base en "V" = Colocación sobre Tubos
V-shape Base for Tube Surface
Base en "V" = Utilisation sur Tubes

785 Nivel Torpedo Trapezoidal 2 Fioles
2 Vial Trapezoid Torpedo Level • Niveau Torpedo Trapézoïdal 2 Fioles



L mm	Part N°	€
300	785-002	24,40

- 2 Fioles · Vial · Fioles • 90° · 180°

785 Nivel Torpedo Tubular 3 Fioles
3 Vial Torpedo Level • Niveau Torpedo Tubulaire 3 Fioles



L mm	Part N°	€
235	785-003	5,44

- 3 Fioles · Vial · Fioles • 45° · 90° · 180°

Calibres y Micrómetro • Calipers & Micrometer • Pieds à Coulisse et Micromètre

796

Calibre de Acero Inoxidable

Stainless Steel Vernier Caliper • Pied à Coulisse en Acier Inoxydable

**0,05
mm**

Inox



 mm	Part N°	€
0 ~ 150	796-150	44,95

797

Calibre Digital

Digital Caliper • Pied à Coulisse Digital

**0,01
mm**



Incluye Manual de Instrucciones y Certificado
Instruction Manual & Certificate Included
Inclut Manuel d'utilisation et Certificat

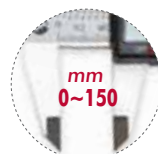

 mm	Part N°	€
0 ~ 150	797-150	63,63

798

Micrómetro Centesimal de Exteriores

Mechanical External Micrometer • Micromètre D'extérieur Mécanique au Centième

**0,01
mm**



 mm	Part N°	€
0 ~ 25	798-25	42,80

Flexómetros • Measuring Tapes • Mètres Ruban

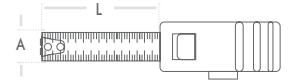

775 Flexómetro Magnético
Magnetic Measuring Tape • Mètre Ruban Magnétique



Nylon



L m	A mm	Part N°	€
3	16	775-03	5,34
5	19	775-05	8,35
8	25	775-08	15,94

776 Flexómetro Magnético con Doble Bloqueo
Double Lock Magnetic Measuring Tape • Mètre Ruban Magnétique avec Double Blocage



Nylon



L m	A mm	Part N°	€
3	16	776-03	5,34
5	19	776-05	8,35
8	25	776-08	15,94

777 Flexómetro Magnético Autoblocante
Self Lock Magnetic Measuring Tape • Mètre Ruban Magnétique avec Auto-Blocage



Nylon



L m	A mm	Part N°	€
3	16	777-03	5,34
5	19	777-05	8,35
8	25	777-08	15,94

Flexómetros • Measuring Tapes • Mètres Ruban

779

Flexómetro Largo con Cinta Metálica

Long Metal Belt Measure Tape • Mètre Ruban Métallique Mesures Longues

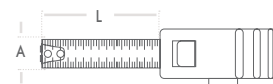

L m	A mm	Part N°	€
20	13	779-20	32,10
30	13	779-30	37,75

• Cinta Extra Suave • Extra Smooth Belt • Ruban Extra-Doux

780

Flexómetro Largo con Cinta Metálica

Long Metal Belt Measure Tape • Mètre Ruban Métallique Mesures Longues



L m	A mm	Part N°	€
20	10	780-20	20,35
30	10	780-30	26,05
50	10	780-50	40,00

Reglas • Rulers • Règles
792
Escuadra Flexible Mango de Aluminio
Flexible Square Aluminium Handle • Fausse Équerre Talon Aluminium

L mm	Part N°	€
200	792-01-200	16,35
250	792-01-250	17,16
300	792-01-300	19,98

792
Regla Inoxidable
Stainless Steel Ruler • Règle en Acier Inoxydable

Inox



L mm	Part N°	€
150	792-02-150	4,73
200	792-02-200	6,48
300	792-02-300	8,93
500	792-02-500	16,10
1.000	792-02-1000	30,38

793
Escuadra Inoxidable Profesional
Professional Stainless Steel Square • Équerre en Acier Inoxydable Professionnelle

Inox



L mm	A mm	B mm	Part N°	€
250	50	3	793-01-250	16,47
300	50	3	793-01-300	18,81
350	50	3	793-01-350	19,24
400	50	3	793-01-400	19,95

793
Escuadra Inoxidable Profesional
Professional Stainless Steel Square • Équerre en Acier Inoxydable Professionnelle

Inox



L mm	A mm	B mm	Part N°	€
300	50	5	793-02-300	21,63
350	50	5	793-02-350	22,12
400	50	5	793-02-400	22,95
450	50	5	793-02-450	25,75
500	50	5	793-02-500	28,35
550	50	5	793-02-550	36,10
600	50	5	793-02-600	44,95

Reglas • Rulers • Règles

793

Escuadra Combinada con Nivel
Combination Square with Level • Equerre Combinée avec Niveau



Inox



L mm	A mm	B mm	Part N°	€
300	24,5	1,8	793-03-300	18,49
400	24,5	1,8	793-03-400	20,59

793

Escuadra Combinada Doble con Nivel
Double Combination Square with Level • Equerre Combinée Double avec Niveau

Inox



L mm	A mm	B mm	Part N°	€
300	24,5	1,8	793-04-300	22,48

796

Transportador de Ángulos
Engineers Protractor • Rapporteur d'angles

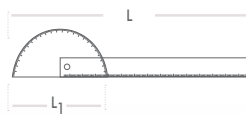

	L mm	L ₁ mm	Part N°	€
0° ~ 180°	200	90	796-001	19,30

796

Punzón Trazador
Steel Scriber • Pointeau à Tracer



L mm	Part N°	€
150	796-002	8,50

Tiralíneas y Polvo Trazador • Chalk Line & Red Powder • Cordeau à Tracer et Poudre Rouge

798

Tiralíneas con Depósito para Polvo Trazador

Chalk Line with Deposit for Chalk Powder • Cordeau à Tracer avec Réservoir pour la Poudre de Traçage

30
m



m	Part N°	€
30	798-001	9,90

798

Polvo Trazador Rojo para Tiralíneas

Chalk Line Red Powder • Poudre Rouge pour Cordeau à Tracer



- Llenar el depósito con polvo trazador rojo.
Fill the deposit with chalk red powder.
Remplir le réservoir avec la poudre rouge de traçage.



- Agitar para impregnar el cordón con el polvo trazador.
Shake to impregnate the line with the chalk powder.
Agiter pour imprégner le cordeau de poudre de traçage.



- 1.- Fijar el gancho a la superficie y tirar hacia arriba.
Fix the hook to the surface and pull it up.
Attacher le crochet à la surface et tirer vers le haut.
- 2.- Soltar • Release • Relâcher



g	Part N°	€
180	798-002	2,98

Corte y Abrasión
Cutting & Abrasion
Coupe et Abrasifs

	312
	313
	318
	321
	324
	327
	328
	329
	330
	331
	332



Formones • Chisels • Ciseaux

800

Formón Mango Bimaterial
Bi-Material Handle Wood Chisel
Ciseau à Bois Manche Bi-Matière

CrV

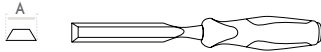

A mm	Part N°	€
6	800-06	14,10
8	800-08	14,53
10	800-10	14,78
12	800-12	15,13
14	800-14	15,47
15	800-15	15,64
16	800-16	15,90
18	800-18	16,17
20	800-20	16,51
22	800-22	17,95
25	800-25	18,41
28	800-28	19,06
30	800-30	19,34
32	800-32	19,70
35	800-35	20,25
38	800-38	20,89

801

Formón Mango Madera
Wooden Handle Wood Chisel
Ciseau à Bois Manche en Bois

CrV

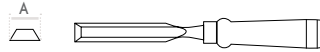

A mm	Part N°	€
6	801-06	8,44
8	801-08	8,44
10	801-10	9,07
12	801-12	9,07
14	801-14	9,91
15	801-15	9,91
16	801-16	10,12
18	801-18	10,74
20	801-20	11,05
22	801-22	12,30
24	801-24	12,95
25	801-25	13,24
26	801-26	13,46
28	801-28	13,97
30	801-30	14,28
32	801-32	14,78
35	801-35	15,42
40	801-40	17,06

800

Juego de Formones Mango Bimaterial
Bi-Material Handle Wood Chisels Set • Jeu Ciseaux à Bois Manche Bi-Matière

5
Pcs

CrV



12 · 20 · 25 mm

Part N°	€
800-001	55,58

- Piedra de Afilar
Sharpening Stone • Pierre à Affûter
- Guía para Afilar
Honing Guide • Guide Affûtage

Limas • Files • Limes



804

Lima Plana de Grano Entrefino Mango Bimaterial

Bi-Material Handle Flat File 2nd Cut • Lime Plate Parallèle Mi-douce Manche Bi-Matière

T12

C % 1,20
Si % 0,20
Mn % 0,80



Entrefino
2nd Cut
Mi-douce



L mm	Part N°	€
150	804-150	6,43
200	804-200	7,51
250	804-250	9,00
300	804-300	11,30

804B

Lima Plana de Grano Basto Mango Bimaterial

Bi-Material Handle Flat File Bastard Cut • Lime Plate Parallèle Gros Grain Manche Bi-Matière

T12

C % 1,20
Si % 0,20
Mn % 0,80



Grano Basto
Bastard Cut
Gros Grain



L mm	Part N°	€
150	804B-150	6,11
200	804B-200	7,14
250	804B-250	8,55
300	804B-300	10,74

805

Lima Media Caña de Grano Entrefino Mango Bimaterial

Bi-Material Handle Half Round File 2nd Cut • Lime Demi-ronde Mi-douce Manche Bi-Matière

T12

C % 1,20
Si % 0,20
Mn % 0,80



Entrefino
2nd Cut
Mi-douce



L mm	Part N°	€
150	805-150	8,29
200	805-200	9,64
250	805-250	11,17
300	805-300	15,38

805B

Lima Media Caña de Grano Basto Mango Bimaterial

Bi-Material Handle Half Round File Bastard Cut • Lime Demi-ronde Gros Grain Manche Bi-Matière

T12

C % 1,20
Si % 0,20
Mn % 0,80



Grano Basto
Bastard Cut
Gros Grain



L mm	Part N°	€
150	805B-150	7,88
200	805B-200	9,16
250	805B-250	10,61
300	805B-300	14,61

Limas • Files • Limes



806

Lima Caña Redonda de Grano Entrefino Mango Bimaterial
Bi-Material Handle Round File 2nd Cut • Lime Ronde Mi-douce Manche Bi-Matière

T12

C % 1,20
Si % 0,20
Mn % 0,80



Entrefino
2nd Cut
Mi-douce



L mm	Part N°	€
150	806-150	6,35
200	806-200	7,05
250	806-250	8,02
300	806-300	11,00

806B

Lima Caña Redonda de Grano Basto Mango Bimaterial
Bi-Material Handle Round File Bastard Cut • Lime Ronde Gros Grain Manche Bi-Matière

T12

C % 1,20
Si % 0,20
Mn % 0,80



Grano Basto
Bastard Cut
Gros Grain



L mm	Part N°	€
150	806B-150	6,03
200	806B-200	6,69
250	806B-250	7,62
300	806B-300	10,45

807

Lima Cuadrada de Grano Entrefino Mango Bimaterial
Bi-Material Handle Square File 2nd Cut • Lime Carrée Parallèle Mi-douce Manche Bi-Matière

T12

C % 1,20
Si % 0,20
Mn % 0,80



Entrefino
2nd Cut
Mi-douce



L mm	Part N°	€
150	807-150	6,75
200	807-200	7,55
250	807-250	9,52
300	807-300	13,00

807B

Lima Cuadrada de Grano Basto Mango Bimaterial
Bi-Material Handle Square File Bastard Cut • Lime Carrée Parallèle Gros Grain Manche Bi-Matière

T12

C % 1,20
Si % 0,20
Mn % 0,80



Grano Basto
Bastard Cut
Gros Grain

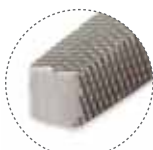

L mm	Part N°	€
150	807B-150	6,41
200	807B-200	7,17
250	807B-250	9,04
300	807B-300	12,35

Limas • Files • Limes



808

Lima Triangular de Grano Entrefino Mango Bimaterial

Bi-Material Handle Triangle File 2nd Cut • Lime Triangulaire Mi-douce Manche Bi-Matière

T12

C % 1,20
Si % 0,20
Mn % 0,80

Entrefino
2nd Cut
Mi-douce

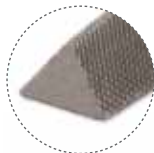

L mm	Part N°	€
150	808-150	7,28
200	808-200	8,66
250	808-250	11,12
300	808-300	13,83

808B

Lima Triangular de Grano Basto Mango Bimaterial

Bi-Material Handle Triangle File Bastard Cut • Lime Triangulaire Gros Grain Manche Bi-Matière

T12

C % 1,20
Si % 0,20
Mn % 0,80

Grano Basto
Bastard Cut
Gros Grain

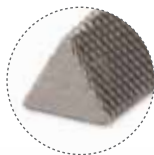

L mm	Part N°	€
150	808B-150	6,92
200	808B-200	8,23
250	808B-250	10,57
300	808B-300	13,13

809

Lima para Afilado de Motosierra

Chain Saw File • Limes pour Affûtage de Chaîne de Tronçonneuse

100 Cr6

C % 0,97
Si % 0,25
Mn % 0,35
Cr % 1,50
Ni % 0,30 max.
Cu % 0,30 max.



L mm	Ø mm	Part N°	€
150	3,2	809-032-150	3,85
150	3,5	809-035-150	3,85
150	4	809-040-150	3,85
200	4,5	809-045-200	4,38
200	5,5	809-055-200	4,38

Escofinas • Rasps • Râpes



812

Escofina Media Caña Mango Bimaterial

Bi-Material Handle Half Round Rasp • Râpe Demi-ronde Manche Bi-Matière

A3

C % 1,25
Cr % 5,00
V % 1,00
Mo % 1,00

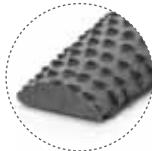

L mm	Part N°	€
150	812-150	9,21
200	812-200	10,19
250	812-250	12,90

813

Escofina Plana Mango Bimaterial

Bi-Material Handle Flat Rasp • Râpe Plate Parallèle Manche Bi-Matière

A3

C % 1,25
Cr % 5,00
V % 1,00
Mo % 1,00

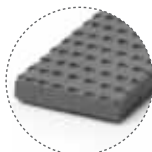

L mm	Part N°	€
200	813-200	11,62
250	813-250	13,51

814

Escofina Redonda Mango Bimaterial

Bi-Material Handle Round Rasp • Râpe Ronde Manche Bi-Matière

A3

C % 1,25
Cr % 5,00
V % 1,00
Mo % 1,00



L mm	Part N°	€
150	814-150	7,53
200	814-200	8,33
250	814-250	10,37

Juegos de Limas • File Sets • Jeux de Limes

815

Juego de 3 Limas Mango Bimaterial

Bi-Material Handle 3 File Set • Jeu 3 Limes Manche Bi-Matière

3

Pcs

T20

200
mm



200mm



200mm



200mm



Entrefino

2nd Cut • Mi-douce



Incluye Funda de Nylon

Includes Canvas Wallet • Includ Étui Nylon

Part N°

€

815-001

29,70

815

Juego de 3 Limas Mango Bimaterial

Bi-Material Handle 3 File Set • Jeu 3 Limes Manche Bi-Matière

3

Pcs

T20

250
mm



250mm



250mm



250mm



Entrefino

2nd Cut • Mi-douce



Incluye Funda de Nylon

Includes Canvas Wallet • Includ Étui Nylon

Part N°

€

815-002

37,48

815

Juego de 5 Limas Mango Bimaterial

Bi-Material Handle 5 File Set • Jeu 5 Limes Manche Bi-Matière

5

Pcs

T20

250
mm



250mm



250mm



250mm



250mm



250mm



Entrefino

2nd Cut • Mi-douce



Incluye Funda de Nylon

Includes Canvas Wallet • Includ Étui Nylon

Part N°

€

815-003

58,58

Limas de Aguja de Diamante • Diamond Needle Files • Limes Diamantées Aiguille

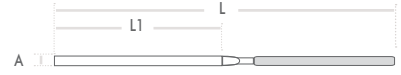

816

Lima de Aguja de Diamante Plana
Flat Diamond Needle File • Lime - Aiguille Diamantée Plate



150
grano
grain



A mm	L1 mm	L mm	Part N°	€
3	70	140	816-01-140	32,16
4	70	160	816-01-160	43,13

816

Lima de Aguja de Diamante Plana en Punta
Flat Point End Diamond Needle File • Lime - Aiguille Diamantée Plate Pointue



150
grano
grain



A mm	L1 mm	L mm	Part N°	€
3	70	140	816-02-140	32,16
4	70	160	816-02-160	43,13

816

Lima de Aguja de Diamante Triangular
Triangle Diamond Needle File • Lime - Aiguille Diamantée Triangulaire



150
grano
grain



A mm	L1 mm	L mm	Part N°	€
3	70	140	816-03-140	32,16
4	70	160	816-03-160	43,13

816

Lima de Aguja de Diamante Cuadrada
Square Point End Diamond Needle File • Lime - Aiguille Diamantée Carrée



150
grano
grain



A mm	L1 mm	L mm	Part N°	€
3	70	140	816-04-140	32,16
4	70	160	816-04-160	43,13

Limas de Precisión de Diamante • Diamond Precision Files • Limes Diamantées de Précision



816

Lima de Aguja de Diamante de Media Luna
Half Round Diamond Needle File • Lime - Aiguille Diamantée Demi-ronde



150
grano
grain



A mm	L1 mm	L mm	Part N°	€
3	70	140	816-05-140	32,16
4	70	160	816-05-160	43,13

816

Lima de Aguja de Diamante Salvia
Flat Round Point End Diamond Needle File • Lime - Aiguille Diamantée Feuille de Sauge



150
grano
grain



A mm	L1 mm	L mm	Part N°	€
3	70	140	816-06-140	32,16

816

Lima de Aguja de Diamante Redonda
Round Diamond Needle File • Lime - Aiguille Diamantée Ronde



150
grano
grain



A mm	L1 mm	L mm	Part N°	€
3	70	140	816-07-140	32,16
4	70	160	816-07-160	43,13

816

Lima de Aguja de Diamante de Cuchilla
Knife Point End Diamond Needle File • Lime - Aiguille Diamantée Couteau



150
grano
grain



A mm	L1 mm	L mm	Part N°	€
3	70	140	816-08-140	32,16

Limas de Precisión de Diamante • Diamond Precision Files • Limes Diamantées de Précision

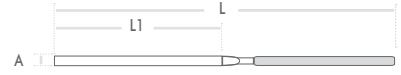

816

Lima de Precisión de Diamante Plana

Flat Diamond Precision File • Lime - Aiguille Diamantée Plate de Précision



150
grano
grain



A mm	L1 mm	L mm	Part N°	€
3	80	215	816-09-215	57,53

816

Lima de Precisión de Diamante de Media Luna

Half Round Diamond Precision File • Lime - Aiguille Diamantée Demi-ronde de Précision



150
grano
grain



A mm	L1 mm	L mm	Part N°	€
3	80	215	816-10-215	57,53

816

Lima de Precisión de Diamante Redonda

Round Diamond Precision File • Lime - Aiguille Diamantée Ronde de Précision



150
grano
grain



A mm	L1 mm	L mm	Part N°	€
6	80	215	816-11-215	57,53

816

Lima de Precisión de Diamante Triangular

Triangle Diamond Precision File • Lime - Aiguille Diamantée Triangulaire de Précision



150
grano
grain





A mm	L1 mm	L mm	Part N°	€
9	80	215	816-12-215	57,53

Cepillos • Brushes • Brosses

818

Cepillo Metálico Circular
Wheel Brush • Brosse Métallique Circulaire



Ø Ext. mm	 mm	 mm	Ø Int. mm	R.P.M. max	Part N°	€
150	20	30	32	6000	818-150-20	17,25
175	20	45	32	6000	818-175-20	19,00
200	20	55	32	4500	818-200-20	21,75





Ø 0,3 mm • Acero Latonado • Brass Coated Steel • Fil Acier Laitonné

819

Cepillo Taza Ondulado
Crimped Cup Brush • Brosse Métallique pour Meuleuse



Ø Ext. mm	 mm		R.P.M. max	Part N°	€
100	25	M14x2	8500	819-100	17,18
125	25	M14x2	8500	819-125	24,45





Ø 0,3 mm • Acero Latonado • Brass Coated Steel • Fil Acier Laitonné

820

Mini Cepillo Taza Ondulado
Crimped Cup Mini Brush • Mini-Brosse Métallique pour Meuleuse



Ø Ext. mm	 mm		R.P.M. max	Part N°	€
75	20	M14x2	8500	820-075	13,75



Ø 0,3 mm • Acero Latonado • Brass Coated Steel • Fil Acier Laitonné

Cepillos • Brushes • Brosses

821

Cepillo Metálico Circular Ondulado

Threaded Hole Wheel Brush • Brosse Métallique Circulaire pour Meuleuse



Ø Ext. mm	mm	mm	R.P.M. max	Part N°	€
115	20	30	M14x2 8500	821-115	14,18



Ø 0,3 mm

• Acero Latonado • Brass Coated Steel • Fil Acier Laitonné

822

Cepillo Cilíndrico Ondulado con Mango

Wheel Brush With Shank • Brosse Métallique Circulaire Sur Tige Pour Perceuse



Ø Ext. mm	mm	mm	R.P.M. max	Part N°	€
50	6	10	4500	822-050	2,88
75	6	10	4500	822-075	3,80
100	6	10	4500	822-100	4,50



Ø 0,3 mm

• Acero Latonado • Brass Coated Steel • Fil Acier Laitonné

823

Cepillo Taza Ondulado con Mango

Cup Brush With Shank • Brosse Métallique sur Tige pour Perceuse



Ø Ext. mm	mm	R.P.M. max	Part N°	€
50	25	4500	823-050	3,25
75	25	4500	823-075	3,90



Ø 0,3 mm

• Acero Latonado • Brass Coated Steel • Fil Acier Laitonné

824

Cepillo Brocha Ondulado con Mango

End Brush • Brosse Pinceau Métallique sur Tige pour Perceuse



Ø Ext. mm	mm	R.P.M. max	Part N°	€
24	25	4500	824-024	4,40



Ø 0,3 mm

• Acero Latonado • Brass Coated Steel • Fil Acier Laitonné

Cepillos • Brushes • Brosses

825

Cepillo Taza Trenzado
Twist Knot Cup Brush • Brosse Métallique pour Meuleuse



Ø Ext. mm	mm		R.P.M. max	Part N°	€
100	25	M14x2	8500	825-100	20,35
125	25	M14x2	6500	825-125	25,03



Ø 0,5 mm • Acero • Grey Steel • Mèches Acier Torsadé

826

Mini Cepillo Taza Trenzado
Twist Knot Cup Mini Brush • Mini-Brosse Métallique pour Meuleuse



Ø Ext. mm	mm		R.P.M. max	Part N°	€
75	25	M14x2	12500	826-075	14,18



Ø 0,5 mm • Acero • Grey Steel • Mèches Acier Torsadé

827

Cepillo Circular de Nylon con Mango
Wide Face Nylon Wheel • Brosse Circulaire Nylon Abrasif sur Tige pour Perceuse



Ø Ext. mm	mm	mm	R.P.M. max	Part N°	€
75	6	10	4500	827-075	7,88
100	6	10	4500	827-100	9,50



Ø 1,2 mm

828

Cepillo Taza de Nylon con Mango
Cup Nylon Brush • Brosse Nylon Abrasif sur Tige pour Perceuse



Ø Ext. mm	mm	R.P.M. max	Part N°	€
50	20	4500	828-050	8,75
75	20	4500	828-075	8,90



Ø 1,2 mm

Cepillos • Brushes • Brosses

830

Cepillo Manual Mango de Madera

Wooden Handle Hand Brush • Brosse Métallique Manuelle Manche Bois

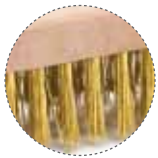

Hileras • Rows • Fils	L mm	Part N°	€
5 x 15	200	830-001	17,18



Ø 0,2 mm

• Alambre de Latón • Brass Wire • Fil Laiton

830

Cepillo Manual Mango de Madera

Wooden Handle Hand Brush • Brosse Métallique Manuelle Manche Bois



Hileras • Rows • Fils	L mm	Part N°	€
5 x 15	200	830-011	12,23



Ø 0,3 mm

• Alambre de Acero Gris
Grey Steel Wire • Fil Acier Gris

830

Cepillo Manual Mango de Madera

Wooden Handle Hand Brush • Brosse Métallique Manuelle Manche Bois



Hileras • Rows • Fils	L mm	Part N°	€
4 x 15	290	830-012	3,83
5 x 15	290	830-013	2,85



Ø 0,3 mm

• Alambre de Acero Pavonado
Black Coated Steel Wire
Fil Acier Bruni

830

Cepillo Manual Mango de Madera

Wooden Handle Hand Brush • Brosse Métallique Manuelle Manche Bois



Hileras • Rows • Fils	L mm	Part N°	€
4 x 15	290	830-002	7,92
5 x 15	290	830-003	9,44



Ø 0,3 mm

• Alambre de Latón • Brass Wire • Fil Laiton

Cepillos • Brushes • Brosses

830

Cepillo Manual en "V" Mango de Madera

Wooden Handle "V" Hand Brush • Brosse Métallique Manuelle en "V" Manche Bois



Hileras · Rows · Fils	L mm	Part N°	€
3 x 15	280	830-021	5,84



Ø 0,3 mm

• Alambre de Acero Latonado
Brass Coated Steel Wire · Fil Acier Laitonné

830

Cepillo Manual Mango de Plástico

Universal Hand Brush • Brosse Métallique Manuelle Manche Plastique



L mm	Part N°	€
250	830-005	6,25



Ø 0,2 mm

• Alambre de Latón
Brass Wire · Fil Laiton

830

Cepillo Manual Mango de Plástico

Universal Hand Brush • Brosse Métallique Manuelle Manche Plastique



L mm	Part N°	€
250	830-022	2,25



Ø 0,3 mm

• Alambre de Acero Latonado
Brass Coated Steel Wire
Fil Acier Laitonné

830

Cepillo Manual Mango de Plástico

Universal Hand Brush • Brosse Métallique Manuelle Manche Plastique



L mm	Part N°	€
250	830-031	6,63



Ø 0,3 mm

• Alambre de Acero Inoxidable
Stainless Steel Wire
Fil Acier Inoxydable

Cepillos • Brushes • Brosses

830

Cepillo Manual Mango de Plástico
Universal Hand Brush • Brosse Métallique Manuelle Manche Plastique



Hileras · Rows · Fils	L mm	Part N°	€
3 x 19	340	830-032	10,48



Ø 0,3 mm

• Alambre de Acero Inoxidable
Stainless Steel Wire · Fil Acier Inoxydable

830

Cepillo Manual Mango de Plástico
Universal Hand Brush • Brosse Métallique Manuelle Manche Plastique



Hileras · Rows · Fils	L mm	Part N°	€
3 x 19	340	830-004	11,76



Ø 0,3 mm

• Alambre de Latón · Brass Wire · Fil Laiton

830

Cepillo Manual Mango de Madera
Universal Hand Brush Wooden Handle • Brosse Métallique Manuelle Manche Bois



Hileras · Rows · Fils	L mm	Part N°	€
3 x 19	290	830-041	5,84



Ø 0,3 mm

• Alambre de Acero Pavnado
Black Coated Steel Wire
Fil Acier Bruni

Serruchos Serie Profesional • Professional Series Hand Saws • Scies Égoïnes Série Professionnelle

835

Serrucho Profesional
Professional Hand Saw • Scie égoïne Professionnelle



ALLIGATOR



L mm	Part N°	€
300	835-300	19,29
350	835-350	20,00
400	835-400	20,15
450	835-450	24,29
500	835-500	27,84
550	835-550	30,72

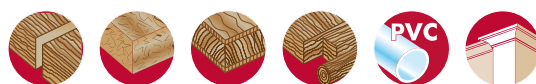

836

Serrucho Profesional
Professional Hand Saw • Scie égoïne Professionnelle



L mm	Part N°	€
300	836-300	17,36
350	836-350	18,00
400	836-400	18,14
450	836-450	21,86
500	836-500	25,05
550	836-550	27,00

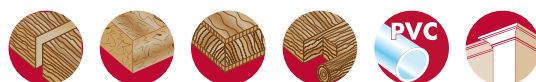

837

Serrucho de Costilla Profesional
Professional Tenon Saw • Scie à Dos Professionnelle



L mm	Part N°	€
250	837-250	11,50
300	837-300	11,99
350	837-350	14,88

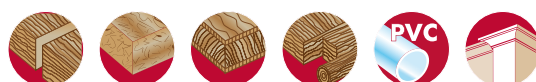

Arcos de Sierra • Hacksaw Frames • Montures de Lames de Scie à Main

840

Arco de Sierra Profesional

Professional Hacksaw Frame • Monture de Lame de Scie à Main Professionnelle



L mm	Part N°	€
300	840-001	27,53

Incluye Hoja Bi-metal • Includes Bi-metal Blade • Includ Lame Bi-métal
Cuerpo de Aluminio • Full Body Aluminium • Monture en Aluminium
45° - 90° • Amarre de la Hoja • Blade Clamping • Attache de la Lame

840

Arco de Sierra

Hacksaw Frame • Monture de Lame de Scie à Main



L mm	Part N°	€
300	840-002	28,88

Incluye Hoja Bi-metal • Includes Bi-metal Blade • Includ Lame Bi-métal
Mango de Aluminio • Aluminium Shank • Manche en Aluminium
Almacén para 10 Hojas • 10 Blades Store • Stockage pour 10 Lames
45° - 90° • Amarre de la Hoja • Blade Clamping • Attache de la Lame

Hojas de Sierra de Mano • Hacksaw Blades • Lames de Scie à Main

840

Hojas de Sierra de Mano Bimetálicas

Bi-Metal Hacksaw Blades • Lames de Scie à Main Bi-Métal

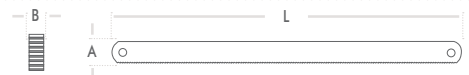

**24
Z**



BI



HSS



L mm	A mm	B mm		Part N°	€
300	13	0,65	100	840-050	1,93

Hojas de Sierra de Mano • Hacksaw Blades • Lames de Scie à Main

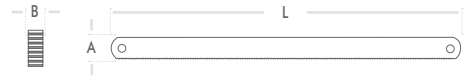

840

Hojas de Sierra de Mano de Acero al Carbono
Carbon Steel Hacksaw Blades • Lames de Scie à Main Acier au Carbone



L mm	A mm	B mm		Part N°	€
300	13	0,65	100	840-051	0,95

840

Hojas de Sierra de Mano Doble Corte para Fontaneros
Carbon Steel Hacksaw Blades for Plumbers • Lames de Scie à Main Acier au Carbone pour Plombiers



L mm	A mm	B mm		Part N°	€
300	25	0,65	100	840-052	0,55

842

Sierra Profesional para Poda
Professional Pruning Saw • Scie d'élagage Professionnelle



L mm	Part N°	€
150	842-001	15,34



843

Sierra Abatible con Mango Bimaterial
Professional Folding Saw • Scie d'élagage Repliable



L mm	Part N°	€
150	843-001	21,95

Cajas de Ingletear • Miter Boxes • Boîtes à Coupe

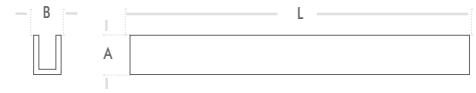

845 Caja de Ingletear
Miter Box • Boîte à Coupe



L mm	A mm	B mm	Part N°	€
300	90	50	845-001	8,64

45° - 90° • Ángulos • Angles • Angles

845 Caja de Ingletear
Miter Box • Boîte à Coupe



L mm	A mm	B mm	Part N°	€
300	140	60	845-002	10,77

45° - 90° • Ángulos • Angles • Angles

845 Caja de Ingletear
Miter Box • Boîte à Coupe



L mm	A mm	B mm	Part N°	€
320	120	75	845-003	13,91

22,5° - 45° - 90° • Ángulos • Angles • Angles

Arcos Tronzadores • Bow Saws • Scies à Bûches

847

Arco de Tronzar
Pruning Bow Saw • Scie à Bûches



L mm	Part N°	€
525	847-525	9,75

Incluye Hoja • Includes Blade • Inclut Lame

848

Arco de Tronzar
Pruning Bow Saw • Scie à Bûches



L mm	Part N°	€
450	848-450	7,78
525	848-525	8,18
600	848-600	8,60
750	848-750	9,35
800	848-800	9,78
900	848-900	10,55

Incluye Hoja • Includes Blade • Inclut Lame

846

Hoja para Madera Verde
Blade for Green Wood • Lame pour Bois Vert



L mm	Part N°	€
450	846-450	2,54
525	846-525	2,54
600	846-600	2,54
750	846-750	2,77
800	846-800	3,23
900	846-900	3,38

849

Hoja para Madera Seca
Blade for Dry Wood • Lame pour Bois Sec



L mm	Part N°	€
450	849-450	2,54
525	849-525	2,54
600	849-600	2,54
750	849-750	2,77
800	849-800	3,23
900	849-900	3,38

Cutters • Cutter Knives • Cutters

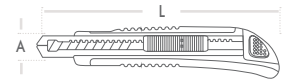

789

Cutter
Utility Cutter Knife • Cutter



A mm	L mm	Part N°	€
9	140	789-09	6,23

- Almacén con 4 cuchillas de repuesto
Storage with 4 spare blades
Magasin avec 4 lames de rechange

789

Cutter
Utility Cutter Knife • Cutter



A mm	L mm	Part N°	€
18	160	789-18	9,14

- Almacén con 7 cuchillas de repuesto
Storage with 7 spare blades
Magasin avec 7 lames de rechange

789

Cutter
Utility Cutter Knife • Cutter



A mm	L mm	Part N°	€
25	200	789-25	12,75

- Almacén con 4 cuchillas de repuesto
Storage with 4 spare blades
Magasin avec 4 lames de rechange
- Accesorios para fracturar la cuchilla y obtener nuevo filo y para colgar
Snap-off dull blade to get a new fresh sharp edge and cutter knife hanger
Accessoires pour casser la lame afin d'obtenir un tranchant neuf et pour accrocher le cutter

789

Cutter Hoja Simple
Cutter Knife Single Blade • Cutter Lame Unique



A mm	L mm	Part N°	€
18	160	789S-18	4,78

- Almacén para cuchillas de repuesto
Storage for spare blades
Magasin pour lames de rechange

Cutters • Cutter Knives • Cutters

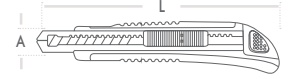

789 Cutter Simple con Tornillo de Bloqueo
Screw Locking Knife Cutter • Cutter à Roulette de Blocage

18 mm



A mm	L mm	Part N°	€
18	160	789-001	4,48



- Almacén para cuchillas de repuesto
Storage for spare blades
Magasin pour lames de rechange



- Utilice la rueda para bloquear la cuchilla a la longitud deseada.
Turn the screw to tighten the blade in the required length.
Utilisez la roulette pour bloquer la lame à la longueur souhaitée.

789 Cutter Simple con Tornillo de Bloqueo
Screw Locking Knife Cutter • Cutter à Roulette de Blocage

18 mm



A mm	L mm	Part N°	€
18	160	789-002	3,99



- Almacén para cuchillas de repuesto
Storage for spare blades
Magasin pour lames de rechange



- Utilice la rueda para bloquear la cuchilla a la longitud deseada.
Turn the screw to tighten the blade in the required length.
Utilisez la roulette pour bloquer la lame à la longueur souhaitée.

789 Cutter Simple con Tornillo de Bloqueo
Screw Locking Knife Cutter • Cutter à Roulette de Blocage

9 mm



A mm	L mm	Part N°	€
9	140	789-003	3,78



- Almacén para cuchillas de repuesto
Storage for spare blades
Magasin pour lames de rechange



- Utilice la rueda para bloquear la cuchilla a la longitud deseada.
Turn the screw to tighten the blade in the required length.
Utilisez la roulette pour bloquer la lame à la longueur souhaitée.

Cutters • Cutter Knives • Cutters



790 Cutter de Seguridad
Heavy Duty Utility Cutter Knife • Cutter de Sécurité



L mm	Part N°	€
155	790-001	10,30

- La cuchilla se recoge automáticamente
Blade automatically turn back
La lame revient automatiquement en arrière

790 Cutter de Seguridad
Heavy Duty Utility Cutter Knife • Cutter de Sécurité

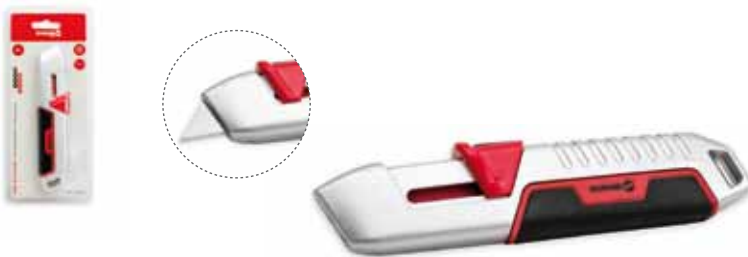

L mm	Part N°	€
165	790-002	10,30

- La cuchilla se recoge automáticamente
Blade automatically turns back
La lame revient automatiquement en arrière

790 Cutter Abatible
Folding Cutter Knife • Cutter Pliant



L mm	Part N°	€
150	790-010	14,98

- Incluye 5 cuchillas de repuesto
Includes 5 spare blades
Inclut 5 lames de rechange

790 Cutter Abatible
Folding Cutter Knife • Cutter Pliant



L mm	Part N°	€
155	790-011	22,48

- Incluye 5 cuchillas de repuesto
Includes 5 spare blades
Inclut 5 lames de rechange
- Pestaña para colgar
Hanger at the back • Attache

Cutters • Cutter Knives • Cutters

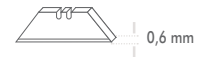

790

Cutter Retrácil

Retractile Cutter Knife • Cutter Rétractable



L mm	Part N°	€
170	790-020	17,63

- Almacén para cuchillas
Blade storage · Magasin pour lames
- Cambio rápido · Quick release · Changement rapide
- Botón de ajuste de longitud de cuchilla
Blade length adjusting button
Bouton de réglage de la longueur de la lame

790

Cutter Retrácil

Retractile Cutter Knife • Cutter Rétractable



L mm	Part N°	€
145	790-030	22,53

- Incluye 4 cuchillas de repuesto
Includes 4 spare blades
Inclut 4 lames de rechange
- Cambio rápido · Quick release · Changement rapide

Accesorios • Accessories • Accessoires



789

Bolsa Individual de Nylon para Cutter

Nylon Bag for Cutter Knife • Etui Individuel en Nylon pour Cutter

Apta para • Suitable for • Apte pour
789-09 / 789-003

Apta para • Suitable for • Apte pour
789-18 / 789S-18 / 789-001 / 789-002

Apta para • Suitable for • Apte pour
789-25



A mm	Part N°	€
9	789V-09	8,25



A mm	Part N°	€
18	789V-18	9,25



A mm	Part N°	€
25	789V-25	10,25

Cuchillas de Repuesto • Spare Blades • Lames de Rechange



789

Cuchillas de Repuesto para Cutter
Cutter Knife Spare Blades • Lames de Rechange pour Cutter



Apta para • Suitable for • Apte pour
789-09



A mm	Part N°	€/10 Pcs
9	789R-09	3,28



Apta para • Suitable for • Apte pour
789-18 / 789S-18



A mm	Part N°	€/10 Pcs
18	789R-18	3,73



Apta para • Suitable for • Apte pour
789-25



A mm	Part N°	€/10 Pcs
25	789R-25	5,12

790

Cuchillas de Repuesto para Cutters de Seguridad y Abatibles
Heavy Duty & Folding Cutter Knife Spare Blades • Lames de Rechange pour Cutter de Sécurité et Cutter Pliant



Apta para • Suitable for • Apte pour
790



Part N°	€/10 Pcs
790-01-10	3,75



Apta para • Suitable for • Apte pour
790



Part N°	€/50 Pcs
790-01-50	16,63



Apta para • Suitable for • Apte pour
790



Part N°	€/5 Pcs
790-02-05	3,88



	338	
		339
		341
		342
		343
		344
	345	
		346
		346



Sargentos y Pinzas • Bar Clamps & Spring Clamps • Serre-joints et Pinces

855

Sargento Automático Ligero

One Handed Bar Clamp • Serre-joint Automatique Léger

120
Kg



L mm	Kg	Part N°	€
150	120	855-150	19,49
300	120	855-300	21,45
450	120	855-450	23,35
600	120	855-600	30,80
750	120	855-750	33,18
900	120	855-900	35,42

856

Sargento Automático Alta Potencia

Heavy Duty Bar Clamp • Serre-joint Automatique Haute Puissance

150
Kg



L mm	Kg	Part N°	€
150	150	856-150	29,67
300	150	856-300	32,49
450	150	856-450	42,91
600	150	856-600	46,27
750	150	856-750	49,70
900	150	856-900	53,06

Pinza y Pinzas de Carraca • Spring & Ratchet Clamps • Pince et Pinces à Cliquet

857

Pinza de Plástico
Spring Clamp • Pince Plastique



L mm	Part N°	€
75	857-075	1,09
100	857-100	1,73
150	857-150	2,53
225	857-225	3,22

858

Pinza de Plástico Alta Potencia
Heavy Duty Spring Clamp • Pince Plastique Haute Puissance



L mm	Part N°	€
75	858-075	1,75
100	858-100	2,80
150	858-150	4,48
225	858-225	5,67

860

Pinza Automática de Carraca de Boca Larga
Long Nose Ratchet Hand Clamp • Pince Automatique à Cliquet à Becs Longs



L mm	Part N°	€
160	860-160	6,09
225	860-225	7,76

Pinza y Pinzas de Carraca • Spring & Ratchet Clamps • Pinces

861

Pinza Automática de Carraca
Ratchet Hand Clamp • Pince Automatique à Cliquet



L mm	Part N°	€
160	861-160	6,09
225	861-225	7,76

862

Pinza Automática de Carraca
Ratchet Hand Clamp • Pince Automatique à Cliquet



L mm	Part N°	€
150	862-150	6,09
200	862-200	7,76

864

Pinza Metálica
Metal Spring Clamp • Pince Métallique



L mm	Part N°	€
50	864-050	1,19
100	864-100	2,89
150	864-150	5,78
225	864-225	10,12

Tornillos de Apriete • "C" Clamps • Presses en "C"

859

Tornillo de Apriete "C"
"C" Clamp • Presse en "C"



L mm	Part N°	€
50	859-050	4,14
75	859-075	6,90
100	859-100	8,22

863

Tornillo de Apriete "C" Forjado
Forged "C" Clamp • Presse en "C" en Acier Forgé



L mm	Part N°	€
50	863-050	20,00
75	863-075	24,00
100	863-100	37,31
150	863-150	51,56

Mordaza y Escuadra Magnética • Corner Clamp & Magnetic Arrow • Équerres

867

Mordaza en Ángulo Recto
Corner Clamp • Équerre à Angle Droit



∟	Part N°	€
90°	867-001	9,35

867

Escuadra Magnética
Magnetic Arrow • Équerre Magnétique

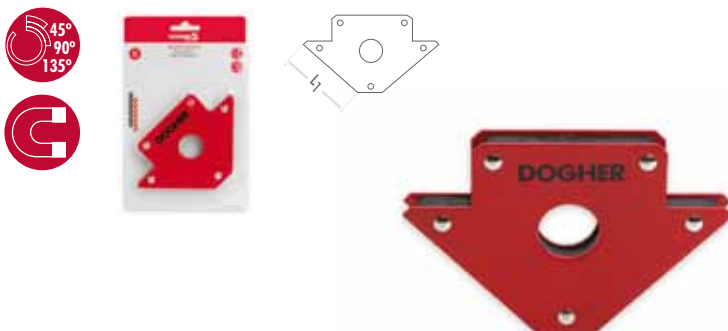

Kg	L ₁ mm	Part N°	€
12	90	867-011	6,82
25	115	867-012	10,70
36	135	867-013	16,74



• Soldadura 90°
90° Welding
Soudure à 90°



• Soldadura 45°/135°
45°/135° Welding
Soudure à 45°/135°

Palas con Mango de Madera • Wooden Handle Shovels • Pelles Manche Bois

- 870 Cabeza de acero anti-desgaste · Head made of anti wear steel · Tête en acier anti-usure
- Acabado antioxidante · Anti-rusty finish · Finition anti-rouille
- Mango de madera de alta resistencia · High resistant wooden handle · Manche bois haute résistance

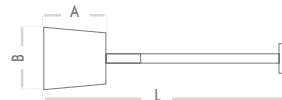

870

Pala Punta con Mango Muleta
T Handle Pointed Shovel
Pelle Pointue Manche Poignée en T



g	A mm	B mm	L mm	Part N°	€
2000	280	340	1020	870-010	17,70

870

Pala Cuadrada con Mango Muleta
T Handle Square Shovel
Pelle Carrée Manche Poignée en T



g	A mm	B mm	L mm	Part N°	€
2000	280	340	1020	870-020	17,70

870

Pala Punta con Mango Anilla
Ring Handle Pointed Shovel
Pelle Pointue Manche Poignée Fermée



g	A mm	B mm	L mm	Part N°	€
2000	280	340	1020	870-030	19,88

870

Pala Cuadrada con Mango Anilla
Ring Handle Square Shovel
Pelle Carrée Manche Poignée Fermée



g	A mm	B mm	L mm	Part N°	€
2000	280	340	1020	870-040	20,23

870

Pala Forestal
Forestry Shovel • Pelle Pointue à Manche Long



g	A mm	B mm	L mm	Part N°	€
2000	33	28	1450	870-050	21,65

Palas de Aluminio Mango de Madera • Wooden Handle **Aluminium Shovels** • **Pelles Aluminium** Manche Bois

- 871 Cabeza de aluminio • Aluminium head • Tête en aluminium
- Acabado antioxidante • Anti-rusty finish • Finition anti-rouille
- Mango de madera de alta resistencia • High resistant wooden handle • Manche bois haute résistance

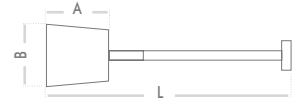

871 Pala de Aluminio con Mango Anilla
Ring Handle Aluminium Shovel
Pelle Aluminium Manche Poignée Fermée



g	A mm	B mm	L mm	Part N°	€
1500	390	315	1130	871-010	31,08

871 Pala de Aluminio con Mango Anilla
Ring Handle Aluminium Shovel
Pelle Aluminium Manche Poignée Fermée



g	A mm	B mm	L mm	Part N°	€
1000	305	245	1020	871-030	25,28

871 Pala de Aluminio
Aluminium Shovel • Pelle Aluminium



g	A mm	B mm	L mm	Part N°	€
1500	390	315	1530	871-020	29,27

Repuestos • Spare Parts • Rechanges

870 Mango Muleta de Madera
Hardwood T Handle • Manche Bois Poignée en T



Apta para • Suitable for • Apte pour
870-010 / 870-020

L mm	Part N°	€
680	870-001	6,02

870 Mango Anilla de Madera
Hardwood Ring Handle • Manche Bois Poignée Fermée



Apta para • Suitable for • Apte pour
870-030 / 870-040

L mm	Part N°	€
700	870-002	8,44

Repuestos • Spare Parts • Rechanges
874
Cabeza Rastrillo

Rake Head • Tête de Râteau



Nº	g	A mm	B mm	Part N°	€
12	575	34	9	874-012	8,95
14	670	41	9	874-014	9,45
16	776	70	9	874-016	9,96

874
Mango Recto para Rastrillo

Spare handle for Rake • Manche Droit pour Râteau

 Apta para • Suitable for • Apte pour
 874-012 / 874-014 / 874-016

L mm	Part N°	€
1200	874-001	10,19

875
Horca

Fork • Fourche

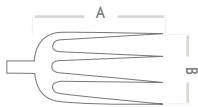

Nº	g	A mm	B mm	Part N°	€
4	755	23	20	875-014	15,03
5	934	33	20	875-015	28,80

875
Mango Anilla para Horca

Ring Handle for Fork

Manche Poignée Fermée pour Fourche

 Apta para • Suitable for • Apte pour
 875-001 ▶ 875-014 / 875-002 ▶ 875-015

L mm	Nº	Part N°	€
1120	4	875-001	33,41
1120	5	875-002	42,55

875
Garabato Profesional

Professional Hay Rake • Croc Professionnel



Nº	g	A mm	B mm	Part N°	€
4	700	22	21	875-024	18,79
5	900	22	20	875-025	16,17

Repuestos • Spare Parts • Rechanges

876

Raedera Rectangular
Rectangular Scraper • Binette Rectangulaire

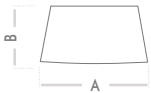

g	A mm	B mm	Part N°	€
1400	310	130	876-010	20,36

876

Raedera Semi-circular
Half Round Scraper • Binette Demi-lune



g	A mm	B mm	Part N°	€
1200	270	160	876-020	18,14

876

Cabeza de Azadilla
Weeder Head • Tête de Rechange

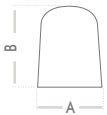

g	A mm	B mm	Part N°	€
500	7	30	876-030	16,14

Barra para Desencofrar • Wrecking Bar • Pince de Décoffrage

884

Barra para Desencofrar
Wrecking Bar • Pince de Décoffrage



L mm	mm	Part N°	€
300	14	884-04-300	9,80
500	20	884-05-500	13,96
600	20	884-05-600	17,94
700	20	884-05-700	20,40
800	22	884-05-800	21,83
900	22	884-05-900	25,47
1000	22	884-05-1000	27,10
1200	22	884-05-1200	30,54

Plomada • Plumb Bob • Plomb

890

Plomada de Latón
Brass Plumb Bob • Plomb en Laiton



g	Part N°	€
225	890-225	20,90
340	890-340	24,20
500	890-500	31,72



- Andamiaje y construcción · Decks & construction · Echafaudages, construction
- Nivelación de teodolitos · Transit placement · Mise à niveau de théodolites
- Incluye cuerda 5 m · Includes 5 m string · Inclut un cordon de 5 mètres

890R

Punta de Repuesto
Spare Point • Tête de Rechange



Apta para • Suitable for • Apte pour
890



g	Part N°	€
225	890R-225	2,32
340	890R-340	2,69
500	890R-500	3,52

- Punta de Acero Templado Reemplazable
Replaceable Hardened Tip
Tête en Acier Trempé Remplaçable

Llave de Carraca para Andamios • Double Socket Scaffolding Wrench • Clé pour Échafaudage

892

Llave de Carraca para Andamios
Double Socket Scaffolding Wrench • Clé pour Échafaudage

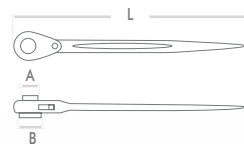

A mm	B mm	L mm	Part N°	€
19	22	240	892-19-22	65,01

Cortador de Pizarra • Slate Cutter • Pince à Ardoise

896

Cortador de Pizarra Profesional
Professional Slate Cutter and Puncher • Pince à Ardoise Professionnelle



L mm	Part N°	€
35	896-35	68,75
55	896-55	77,90

- **7 mm** Espesor max. de Corte y Perforación de Pizarra
Maximum Cutting and Drilling Thickness
Épaisseur max. de Coupe et Perforation d'ardoise
- **2,8 mm** Ancho de Corte · Cutting Width · Largeur de Coupe

Herramienta Variada
Varied Tools
Outils Divers

	348	
	348	
		349
	350	
	351	
		352



Tronzatuercas • Nut Splitter • Casse-Boulons

901

Tronzatuercas Profesional
Professional Nut Splitter • Casse-Boulons Professionnel

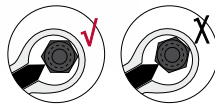

mm	Part N°	€
M3 ~ M12	901-03-12	33,08
M12 ~ M16	901-12-16	38,63
M16 ~ M22	901-16-22	47,75

- Retira tuercas atascadas sin dañar la rosca.
Splits nut up without damaging the thread.
Enlève les boulons bloqués sans abîmer le filetage.
- Coloque el tronzatuercas como se indica en el dibujo para un correcto uso de la herramienta.
Place the nut splitter as indicated in the drawing for a correct use of the tool.
Placez le casse-boulons comme indiqué sur le schéma pour une utilisation correcte de l'outil.

Extractores • Gear Pullers • Extracteurs

902

Extractor Reversible de 2 Patas
Reversible 2 Arm Gear Puller • Extracteur à 2 Griffes Réversible

CrV

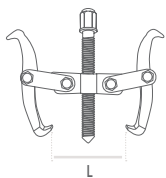

L mm	Part N°	€
75	902-075	34,68
100	902-100	40,83
150	902-150	54,70
200	902-200	99,73
300	902-300	214,95

903

Extractor Reversible de 3 Patas
Reversible 3 Arm Gear Puller • Extracteur à 3 Griffes Réversible

CrV

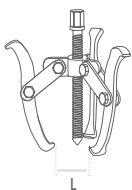

L mm	Part N°	€
75	903-075	41,61
100	903-100	48,99
150	903-150	65,64
200	903-200	119,67
300	903-300	314,95

Pistolas Selladoras • Caulking Guns • Pistolets à Silicone

910

Pistola Selladora Cuerpo de Acero
Steel Body Caulking Gun • Pistolet à Silicone Corps en Acier

Ø mm
50



L mm	Ø mm	Part N°	€
225	50	910-225	4,98
250	50	910-250	8,87

911

Pistola Selladora Mango de Zinc
Caulking Gun Zinc Handel • Pistolet à Silicone Manche en Zinc

Ø mm
50



L mm	Ø mm	Part N°	€
225	50	911-225	8,25

912

Pistola Selladora Mango de Aluminio
Caulking Gun Aluminium Handel • Pistolet à Silicone Manche en Aluminium

Ø mm
50



L mm	Ø mm	Part N°	€
225	50	912-225	17,55
250	50	912-250	18,08

• Reducción de Esfuerzo del 50%
50% Less Effort · 50% d'Effort en Moins

Aplicador de Mortero • Mortar Caulking Gun • Pistolet à Mortier

913

Aplicador de Mortero Cuerpo de Aluminio

Aluminium Body Mortar Caulking Gun • Pistolet à Mortier Corps en Aluminium

Ø mm
50



L mm	Ø mm	Part N°	€
225	50	913-225	17,00
300	50	913-300	17,75
375	50	913-375	20,25

Accesorios para Aplicador de Mortero • Mortar Caulking Gun Accessories • Accessoires pour Pistolet à Mortier

913

Boquillas de Repuesto para Aplicador de Mortero

Mortar Caulking Gun Spare Nozzles • Embouts de Rechange pour Pistolet à Mortier

2
Pcs

Apta para • Suitable for • Apte pour
913



Part N°	€/ 2Pcs
913-001	1,57

Tornillos de Banco Profesionales • Professional Bench Vices • Étaux Professionnels

925

Tornillo de Banco de Guía Redonda
Cylindrical Bench Vice • Étau D'établi Guide Rond

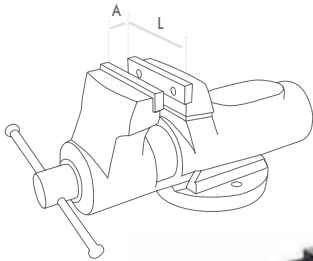

L mm	A mm	Kg	Part N°	€
100	105	13	925-100	282,45
125	130	22	925-125	388,90
150	155	32	925-150	555,30

926

Tornillo de Banco de Guía Cuadrada
Square Guided Bench Vice • Étau D'établi Guide Carré

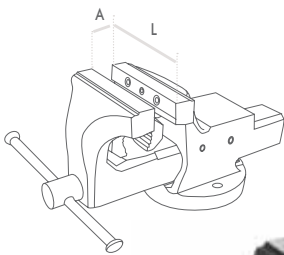

L mm	A mm	Kg	Part N°	€
100	105	7,5	926-100	172,45
125	130	12	926-125	192,18
150	155	17	926-150	277,45
175	175	26	926-175	439,40

• Incluye Mordaza para Tubo
Pipe Jaws Included • Includ Mors pour Tube

Accesorios para Tornillos de Banco • Bench Vice Accessories • Accessoires pour Étaux

925R

Mordazas de Repuesto
Spare Jaws • Mors de Rechange

Apta para • Suitable for • Apte pour
925

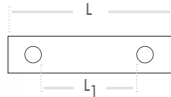

L mm	L ₁ mm	Part N°	€/ 2Pcs
100	53	925R-100	23,09
125	73	925R-125	34,16
150	88	925R-150	41,80

926R

Mordazas de Repuesto
Spare Jaws • Mors de Rechange

Apta para • Suitable for • Apte pour
926

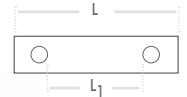

L mm	L ₁ mm	Part N°	€/ 2Pcs
100	24	926R-100	27,80
125	28	926R-125	32,80
150	43	926R-150	37,45
175	53	926R-175	41,93

926B

Base Giratoria
Revolving Base • Base Tournante

Apta para • Suitable for • Apte pour
926



L mm	Part N°	€
100	926B-100	27,45
125	926B-125	29,43
150	926B-150	37,80
175	926B-175	59,68

EXP

Expositores
Displays
Présentoirs

Expositores de Sobremesa

Desktop Displays • Présentoirs de Comptoir

354

Implantaciones

Store Displays • Implantations

360





Expositores de Sobremesa • Desktop Displays • Présentoirs de Comptoir

EXP

Alicates Serie Alta Potencia y Profesionales

High Leverage and Professional Pliers • Pincas Série Haute Performance et Professionnelles

50
Pcs

CrV



- Serie Alta Potencia
High Leverage Series • Série Haute Performance
- Alicates Serie Profesional
Professional Series Pliers • Pincas Série Professionnelle



- Alicates Serie Profesional • *Professional Series Pliers • Pincas Série Professionnelle*



400 x 220 x 820 mm

Part N°

€

EXP01

1.277,60



Expositores de Sobremesa • Desktop Displays • Présentoirs de Comptoir

EXP

Alicates Aislados
Insulated Pliers • Pinces Isolées

50
Pcs

CrV



• Alicates Aislados • *Insulated Pliers • Pinces Isolées*



180mm
(x5)

160mm
(x5)



180mm
(x5)

160mm
(x5)



240mm
(x5)

• Alicates Aislados • *Insulated Pliers • Pinces Isolées*



160mm
(x5)



200mm
(x5)

160mm
(x5)



160mm
(x5)



160mm
(x5)

400 x 220 x 820 mm



Part N°

€

EXP02

1.549,05

Expositores de Sobremesa • Desktop Displays • Présentoirs de Comptoir

EXP

Destornilladores Serie Profesional

Professional Series Screwdrivers • Tournevis Série Professionnelle

136

Pcs

CrMo



• Destornilladores Serie Profesional Professional Series Screw Drivers • Tournevis Série Professionnelle					• Articulado de Carraca con Bola de Retención Flexible Ratcheting • Articulé à Cliquet à Bille de Maintien					
Plana Stamped Mécanicien		8x175 (x5)	6,5x150 (x6)	5,5x125 (x6)	4x100 (x6)			343-007 (x5)		
• Destornilladores Serie Profesional Professional Series • Série Professionnelle					• Extra Corto Reversible de Carraca Extra Short Reversible Ratcheting • Extra Court à Cliquet Reversible					
Recta Milled Electricien		6,5x150 (x6)	5,5x150 (x6)	4x125 (x6)	3x100 (x6)	2,5x75 (x6)	6,5x25 (x6)			343-006 (x6)
• Alicates Serie Profesional • Professional Series Pliers • Pinces Série Professionnelle										
Torx		T30x115 (x6)	T20x100 (x6)	T15x80 (x6)	T10x80 (x6)	Pozidriv		PZ2x125 (x6)	PZ1x100 (x6)	PZ0x75 (x6)
Phillips		PH2x125 (x6)	PH1x100 (x6)	PH0x75 (x6)	PH2x25 (x6)					

400 x 220 x 820 mm

Part N°	€
EXP03	821,71

EXP

Destornilladores Aislados Serie Profesional

Insulated Professional Series Screwdrivers • Tournevis Isolés Série Professionnelle

110

Pcs

CrMo



• Destornilladores Aislados • Insulated Screwdrivers • Tournevis Isolés													
Recta Milled Electricien		8x175 (x5)	6,5x150 (x6)	5,5x125 (x6)	4x100 (x6)	3x100 (x6)	2,5x75 (x6)	Phillips		PH3x150 (x5)	PH2x100 (x6)	PH1x80 (x6)	PH0x60 (x6)
• Destornilladores Aislados • Insulated Screwdrivers • Tournevis Isolés													
Vaso Hex Hex Nut Douille Hex		13x125 (x5)	10x125 (x6)	8x125 (x6)	7x125 (x6)	6x125 (x6)	Pozidriv		PZ3x150 (x5)	PZ2x100 (x6)	PZ1x80 (x6)	PZ0x60 (x6)	

400 x 220 x 820 mm

Part N°	€
EXP04	1.197,22

Expositores de Sobremesa • Desktop Displays • Présentoirs de Comptoir

EXP

Destornilladores Aislados y Serie Profesional

Insulated and Professional Series Screwdrivers • Tournevis Isolés et Série Professionnelle

126

Pcs

CrMo

CrMo



• Destornilladores Aislados • Insulated Screwdrivers • Tournevis Isolés

Recta Milled Electricien  **6,5x150** **5,5x125** **4x100** **3x100** **2,5x75**
(x6) (x6) (x6) (x6) (x6)

Phillips  **PH2x100** **PH1x80** **PH0x60** Pozidriv  **PZ2x100** **PZ1x80**
(x6) (x6) (x6) (x6) (x6)

• Destornilladores Serie Profesional • Professional Series Screwdrivers • Tournevis Série Professionnelle

Recta Milled Electricien  **6,5x150** **5,5x150** **4x125** **3x100** **2,5x75**
(x6) (x6) (x6) (x6) (x6)

Phillips  **PH2x125** **PH1x100** **PH0x75** Pozidriv  **PZ2x125** **PZ1x100** **PZ0x75**
(x6) (x6) (x6) (x6) (x6) (x6)

400 x 220 x 820 mm



Part N°

€

EXP05

807,18

EXP

Destornilladores Serie Industrial y Serie Profesional

Industrial and Professional Series Screwdrivers • Tournevis Série Industrielle et Série Professionnelle

128

Pcs

CrMo

CrMo



• Destornilladores Serie Industrial • Industrial Series Screwdrivers • Tournevis Série Industrielle

Recta Milled Electricien  **8x175** **6,5x150** **5,5x125** Plana Stamped Mécanicien  **8x175** **6,5x150** **5,5x125**
(x5) (x6) (x6) (x6) (x5) (x6) (x6)

Phillips  **PH3x150** **PH2x125** **PH1x100** Pozidriv  **PZ2x125** **PZ1x100**
(x5) (x6) (x6) (x6) (x6) (x6)

• Destornilladores Serie Profesional • Professional Series Screwdrivers • Tournevis Série Professionnel

Plana Stamped Mécanicien  **6,5x150** **5,5x125** **4x100** Recta Milled Electricien  **5,5x150** **4x125** **3x100**
(x5) (x6) (x6) (x6) (x6) (x6) (x6)

Phillips  **PH2x125** **PH1x100** **PH0x75** Pozidriv  **PZ2x125** **PZ1x100**
(x6) (x6) (x6) (x6) (x6)

400 x 220 x 820 mm

Part N°

€

EXP06

863,06

Expositores de Sobremesa • Desktop Displays • Présentoirs de Comptoir

EXP

Puntas de Atornillar
Screwdriver Bits • Embouts de Vissage

164
Boxes

S2



• Puntas de Atornillar • Screwdriver Bits • Embouts de Vissage

Phillips		25 mm	PH1-10 (x5)	PH2-10 (x5)	PH3-10 (x5)	Pozidriv		25 mm	PZ1-10 (x5)	PZ2-10 (x5)	PZ3-10 (x5)
Phillips TiN		25 mm	PH1-5 (x5)	PH2-5 (x5)	PH3-5 (x5)	Pozidriv TiN		25 mm	PZ1-5 (x5)	PZ2-5 (x5)	PZ3-5 (x5)
Recta Slot Plat		25 mm	3,5-10 (x5)	4,5-10 (x5)	5,5-10 (x5)	Hex		25 mm	HX030-10 (x5)	HX040-10 (x5)	HX050-10 (x5)
Torx		25 mm	T10-10 (x5)	T15-10 (x5)	T20-10 (x5)	T25-10 (x5)	T30-10 (x5)	T40-10 (x5)			
Phillips		50 mm	PH1-10 (x5)	PH2-10 (x5)	PH3-10 (x5)	Pozidriv		50 mm	PZ1-10 (x5)	PZ2-10 (x5)	PZ3-10 (x5)

• Portapuntas Magnéticos
Magnetic Bit Holder • Porte-Embouts Magnétique

• Juegos de Puntas
Screwdriver Bit Sets • Jeux d'Embouts de Vissage

	1/4"	443-058 (x4)	SDS Plus		445-001 (x4)		1/4"	32 Pcs	438-002 (x3)	438-001 (x3)
--	------	-----------------	----------	--	-----------------	--	------	--------	-----------------	-----------------

400 x 220 x 820 mm

Part N°	€
EXP07	492,39

EXP

Llaves Ajustables
Adjustable Wrenches • Clés à Molette

39
Pcs

CrV



• Llaves Ajustables Moleta Lateral 15°
Spanish Adjustable Wrenches • Clés à Molette Latérale

• Llaves Ajustables Moleta Central 15°
Spanish Adjustable Wrenches • Clés à Molette Latérale

	300mm (x3)	250mm (x3)	200mm (x3)	150mm (x3)		250mm (x3)	200mm (x3)	150mm (x3)
--	---------------	---------------	---------------	---------------	--	---------------	---------------	---------------

• Llaves Ajustables Gran Apertura
Extra Wide Adjustable Wrenches • Clés à Molette Ouverture Extra

• Llaves Ajustables de Carraca Moleta Central
Ratcheting Adjustable Wrenches • Clés à Molette à Cliquet

	250mm (x3)	200mm (x3)	150mm (x3)		150mm (x3)	200mm (x3)	250mm (x3)
--	---------------	---------------	---------------	--	---------------	---------------	---------------

400 x 220 x 820 mm

Part N°	€
EXP08	1.194,15

Expositores de Sobremesa • Desktop Displays • Présentoirs de Comptoir

EXP

Llaves de Vaso Hexagonal
Hexagonal Sockets • Douilles Hexagonales

309

Pcs

CrV



428 x 355 x 320 mm

• Llave de Carraca • Ratched Handle • Cliquet



72 dientes
72 teeth • 72 dents

1/2"

250mm
(x4)

1/4"

145mm
(x7)

1/4" • Llaves de Vaso • Sockets • Douilles

Hex 13 (x8) 12 (x8) 11 (x8) 10 (x8) 9 (x8) 8 (x8) 7 (x8) 6 (x8) 5,5 (x8) 5 (x8) 4,5 (x8) 4 (x8)

1/4" • Llaves de Vaso con Punta • Socket Bits • Douilles-Embouts de Vissage

Hex HX8 (x8) HX6 (x8) HX5 (x8) HX4 (x8) HX3 (x8) Torx T30 (x8) T20 (x8) T15 (x8)
Phillips PH2 (x8) PH1 (x8) Recta Slot Plat 6,5 (x8) 5,5 (x8) 4 (x8)

1/2" • Llaves de Vaso • Sockets • Douilles

Hex 32 (x5) 30 (x5) 27 (x6) 24 (x6) 22 (x6) 21 (x7) 19 (x7) 17 (x8) 15 (x8) 14 (x8) 13 (x8) 12 (x8) 11 (x8) 10 (x8)

Vasos Sockets • Douilles	Part N°	€
Hexagonal	EXP09	1.831,99
Bihexagonal	EXP10	1.831,99

EXP

Cutters
Cutter Knives • Cutters

58

Pcs



• Tornillo de Bloqueo • Hoja Simple • Tornillo de Bloqueo • Hoja Simple
Screw Locking • à Roulette de Blocage Single Blade • Lame Unique Screw Locking • à Roulette de Blocage Single Blade • Lame Unique



789-001
(x10)
18mm



789S-18
(x10)
18mm



789-003
(x10)
9mm



789-09
(x10)
9mm

• De Seguridad
Heavy Duty • De Sécurité



790-002
(x6)

• Retráctil
Retractable • Rétractable



790-030
(x6)

• Abatible
Folding • Pliant



790-010
(x6)

400 x 220 x 820 mm

Part N°	€
EXP11	479,56

Implantaciones • Store Displays • Implantations

EXP

Implantación de Alicates y Tenazas

Pliers & Pincers Store Display • Implantation de Pinces et Tenailles



• Alicates Serie Profesional • Profesional Series Pliers • Pinces Série Professionnelle

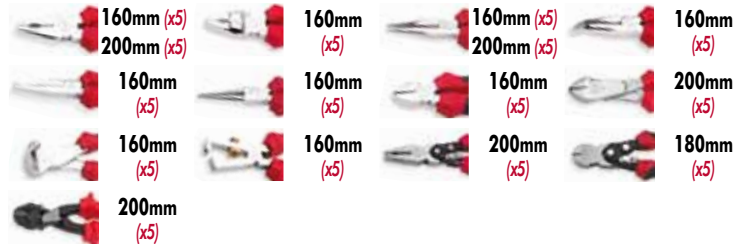

• Alicates para Arandelas Seeger • Seeger Circlip® Pliers • Pinces pour Circlips®



• Alicates Serie Alta Potencia • High Leverage Series Pliers • Pinces Série Haute Performance



• Tenazas • Pincers • Tenailles



• Alicates Aislados • Insulated Pliers • Pinces Isolées

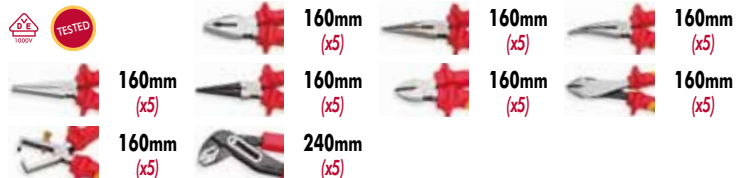

• Tijeras Contrachapa • Aviation Tin Snips • Cisailles à Tôle



• Tenazas Grip • Locking Pliers • Pinces-Étaux



• Herramientas para Electricista • Electrician Tools • Outils d'Electricien



• Cortabulones • Bolt Cutters • Coupe-Boulons



1000 x 400 x 2200 mm

Part N°	€
EXP12	5.886,70

Implantaciones • Store Displays • Implantations

EXP

Implantación de Destornilladores
Screwdriver Store Display • Implantation de Tournevis



• Serie Industrial Plus • Industrial Plus Series • Série Industrielle Plus

Recta Milled Electricien	3x100 (x5)	4x125 (x5)	6x150 (x5)	Torx	T10 (x5)	T15 (x5)	T20 (x5)	T25 (x5)	T30 (x5)	T40 (x5)	
Phillips	PH1x100 (x5)	PH2x125 (x5)	PH3x150 (x5)	Pozidriv	PZ1x100 (x5)	PZ2x125 (x5)	PZ3x150 (x5)				

• Serie Industrial • Industrial Series • Série Industrielle

Plana Stamped Mécanicien	5,5x125 (x5)	6,5x150 (x5)	8x175 (x5)	10x200 (x5)							
Phillips	PH1x100 (x5)	PH2x125 (x10)	PH3x150 (x10)		Estuche Box Coffret	5 Pcs				315-001 (x2)	
Pozidriv	PZ1x100 (x5)	PZ2x125 (x10)	PZ3x150 (x10)		Estuche Box Coffret	5 Pcs				315-002 (x2)	
Torx Seguridad Torx Tamper Torx Sécurité					Caja Box Etui	5 Pcs				319-001 (x2)	

• Serie Profesional • Professional Series • Série Professionnelle

Plana Stamped Mécanicien	3x75 (x5)	4x100 (x5)	5,5x125 (x5)	6,5x150 (x5)	8x175 (x5)	10x200 (x5)					
Recta Milled Electricien	3x100 (x5)	4x125 (x5)	5,5x125 (x5)	6,5x150 (x5)							
Pozidriv	PZ1x100 (x5)	PZ2x125 (x10)	PZ3x150 (x10)		Hex	HR6x125 (x5)	HR8x150 (x5)				
Phillips	PH1x100 (x5)	PH2x125 (x10)	PH3x150 (x10)		Estuche Box Coffret	5 Pcs				330-001 (x2)	
Torx	T10 (x5)	T15 (x5)	T20 (x5)	T25 (x5)	T30 (x5)	T40 (x5)				Caja Box Etui	6 Pcs 340-001 (x2)

• Serie Standard • Standard Series • Série Standard

Plana Stamped Mécanicien	5,5x125 (x5)	6,5x125 (x5)	8x175 (x5)	10x200 (x5)							
Phillips	PH2x150 (x5)	PH3x150 (x5)			Pozidriv	PZ2x125 (x5)	PZ3x150 (x5)				
Torx	T10 (x5)	T15 (x5)	T20 (x5)	T25 (x5)	T30 (x5)	T40 (x5)					

• Serie Antideslizante • Anti-Slip Series • Série Anti-glisse

Phillips	PH2x125 (x5)	PH3x150 (x5)			Estuche Box Coffret	6 Pcs				351-001 (x2)	
Pozidriv	PZ2x125 (x5)	PZ3x150 (x5)			Estuche Box Coffret	6 Pcs				351-002 (x2)	
Torx	T10 (x5)	T15 (x5)	T20 (x5)	T25 (x5)	T30 (x5)						

• Aislados Serie Profesional • Insulated Professional Series • Isolés Série Professionnelle

Recta Milled Electricien	3x100 (x5)	4x100 (x5)	5,5x125 (x5)	6,5x150 (x5)	8x175 (x5)						
Vaso Hex Hex Nut Douille Hex	6x125 (x5)	7x125 (x5)	8x125 (x5)	10x125 (x5)							
Phillips	PH1x80 (x5)	PH2x100 (x5)	PH3x150 (x5)							Estuche Box Coffret	7 Pcs 360-001 (x2)
Pozidriv	PZ1x80 (x5)	PZ2x100 (x5)	PZ3x150 (x5)							Estuche Box Coffret	7 Pcs 360-002 (x2)

Part N°

€

EXP13

5.207,58

1000 x 400 x 2200 mm

Implantaciones • Store Displays • Implantations

EXP

Implantación de Llaves

Wrench Store Display • Implantation de Clés



1000 x 400 x 2200 mm

• Llaves de Doble Boca Estrella Plana • Double Ring Flat Wrenches • Clés Polygone Plate



6 x 7	8 x 9	10x11	12x13	14x15	16x17	17x19	18x19
(x5)	(x5)	(x5)	(x5)	(x5)	(x2)	(x2)	(x2)
20x22	21x23	24x26	24x27	25x28			
(x2)	(x2)	(x2)	(x2)	(x2)			

• Llaves Doble Boca Abierta • Double Open Ended Wrenches • Clés à Fourches



6 x 7	7 x 8	8 x 9	8 x10	10x11	10x12	10x13	11x13
(x5)	(x5)	(x5)	(x5)	(x5)	(x5)	(x5)	(x5)
12x13	12x14	13x15	13x17	14x15	16x17	16x18	17x19
(x5)	(x5)	(x5)	(x5)	(x5)	(x2)	(x2)	(x2)
18x19	19x22	20x22	21x23	22x24	24x26	24x27	25x28
(x2)	(x2)	(x2)	(x2)	(x2)	(x2)	(x2)	(x2)
27x29	27x30	27x32	30x32				
(x2)	(x2)	(x2)	(x2)				

Juegos
Sets • Jeux

6 450-016
Pcs (x2)

8 450-018
Pcs (x2)

• Llaves Combinadas • Combination Wrenches • Clés Mixtes



6	7	8	9	10	11	12	13
(x5)	(x5)	(x5)	(x5)	(x5)	(x5)	(x5)	(x5)
14	15	16	17	18	19	20	21
(x5)	(x5)	(x2)	(x2)	(x2)	(x2)	(x2)	(x2)
22	23	24	25	26	27	28	29
(x2)	(x2)	(x2)	(x2)	(x2)	(x2)	(x2)	(x2)
30	32						
(x2)	(x2)						

Juegos
Sets • Jeux

6 451-016
Pcs (x2)

12 451-022
Pcs (x2)

• Llaves Ajustables Moleta Lateral • Spanish Adjustable Wrenches • Clés à Molette Latérale



150 mm	200 mm	250 mm	300 mm	400 mm
(x4)	(x4)	(x4)	(x3)	(x2)

• Llaves Ajustables Moleta Central • Professional Adjustable Wrenches • Clés à Molette Prof.



150 mm	200 mm	250 mm	300 mm	380 mm
(x4)	(x4)	(x4)	(x3)	(x2)

• Llaves Ajustables Gran Apertura • Extra Wide Adjustable Wrenches • Clés à Molette Ouverture Extra



150 mm	200 mm	250 mm
(x4)	(x4)	(x4)

Part N°

€

EXP14

4.278,43

Implantaciones • Store Displays • Implantations

EXP

Implantación de Llaves

Wrench Store Display • Implantation de Clés



1000 x 400 x 2200 mm

• Llaves Doble Boca Abierta • Double Open Ended Wrenches • Clés à Fourches

	6 x 7 (x5)	7 x 8 (x5)	8 x 9 (x5)	8 x10 (x5)	10x11 (x5)	10x12 (x5)	10x13 (x5)	11x13 (x5)		
	12x13 (x5)	12x14 (x5)	13x15 (x5)	13x17 (x5)	14x15 (x5)	16x17 (x2)	16x18 (x2)	17x19 (x2)		
	18x19 (x2)	19x22 (x2)	20x22 (x2)	21x23 (x2)	22x24 (x2)	24x26 (x2)	24x27 (x2)	25x28 (x2)		
	27x29 (x2)	27x30 (x2)	27x32 (x2)	30x32 (x2)						
								• Juegos Sets • Jeux	8 Pcs	450-018 (x2)

• Llaves Combinadas de Carraca Reversible

Combination Gear Wrenches • Clés Mixtes à Cliquet Réversible										
	6 (x3)	7 (x3)	8 (x3)	9 (x3)	10 (x3)	11 (x3)	12 (x3)	13 (x3)		
	14 (x3)	15 (x3)	16 (x2)	17 (x2)	18 (x2)	19 (x2)	20 (x2)	21 (x2)		
	22 (x2)	24 (x2)	27 (x2)	30 (x2)						
								• Juegos Sets • Jeux	5 Pcs	457-015 (x2)
								5 Pcs	459-015 (x2)	

• Llaves de Estrella Acodada • Double Ring Wrenches • Clés Polygoneales Contre-coudées

	6 x 7 (x3)	8 x 9 (x3)	8x10 (x3)	10x11 (x3)	10x12 (x3)	12x13 (x3)	12x14 (x3)	13x15 (x3)		
	13x17 (x3)	14x15 (x3)	16x17 (x2)	17x19 (x2)	18x19 (x2)	19x22 (x2)	20x22 (x2)	21x23 (x2)		
	22x24 (x2)	24x26 (x2)	24x27 (x2)	25x28 (x2)	27x29 (x2)	27x30 (x2)	30x32 (x2)			
								• Juegos Sets • Jeux	6 Pcs	453-016-2 (x2)

• Llaves Ajustables Moleta Lateral • Spanish Adjustable Wrenches • Clés à Molette Latérale

	150 mm (x4)	200 mm (x4)	250 mm (x4)	300 mm (x3)
-------------------------------------------------------------------------------------	-----------------------	-----------------------	-----------------------	-----------------------

• Llaves Ajustables Moleta Central • Professional Adjustable Wrenches • Clés à Molette Prof.

	150 mm (x4)	200 mm (x4)	250 mm (x4)	300 mm (x3)
-------------------------------------------------------------------------------------	-----------------------	-----------------------	-----------------------	-----------------------

• Llaves Ajustables Gran Apertura • Extra Wide Adjustable Wrenches • Clés à Molette Ouverture Extra

	150 mm (x4)	200 mm (x4)	250 mm (x4)
-------------------------------------------------------------------------------------	-----------------------	-----------------------	-----------------------

• Llaves Ajustables de Carraca Moleta Central • Ratcheting Adjustable Wrenches • Clés à Molette à Cliquet

	150 mm (x3)	200 mm (x3)	250 mm (x3)
-------------------------------------------------------------------------------------	-----------------------	-----------------------	-----------------------

Part N°

€

EXP15

5.516,49

Implantaciones • Store Displays • Implantations

EXP

Implantación de Vasos

Socket Store Display • Implantation de Douilles

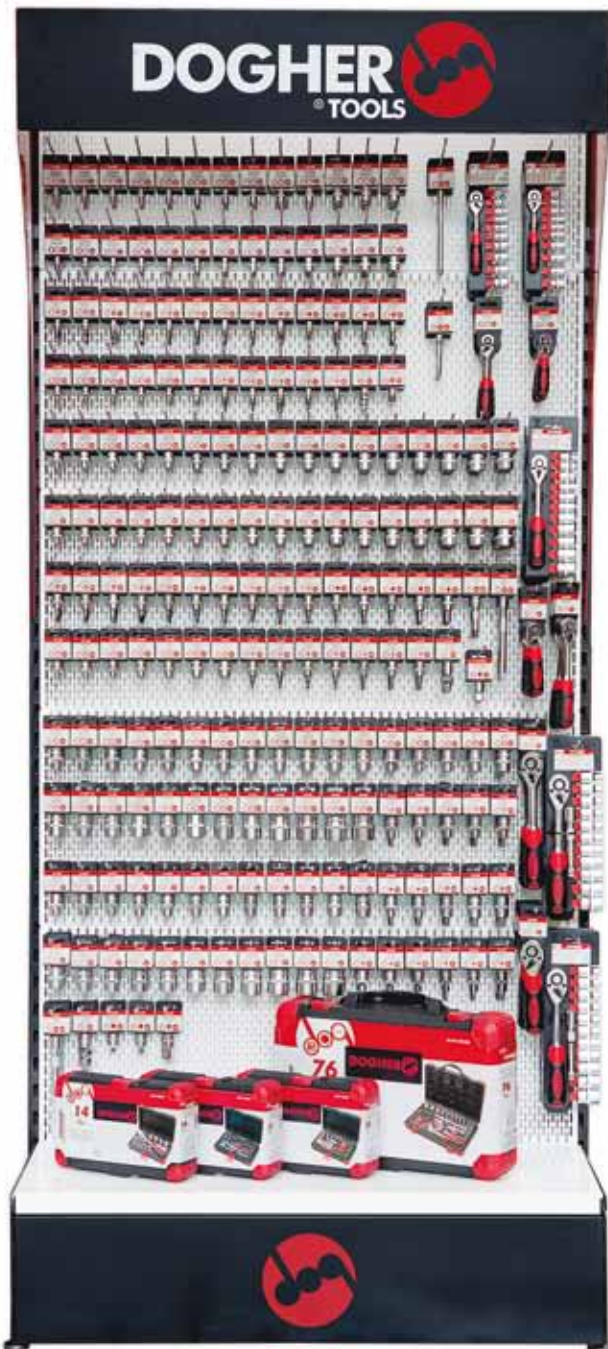

1/4" • Llaves de Vaso • Sockets • Douilles

Hex 4 (x4) 4,5 (x4) 5 (x4) 5,5 (x4) 6 (x4) 7 (x4) 8 (x4) 9 (x4) 10 (x4) 11 (x4) 12 (x4)
Bihex 13 (x4) 14 (x4)

Torx E04 (x4) E05 (x4) E06 (x4) E07 (x4) E08 (x4) E10 (x4)

1/4" • Llaves de Vaso con Punta • Socket Bits • Douilles-Embouts de Vissage

Recta Slot Plat 4 (x4) 5,5 (x4) 6,5 (x4) 8 (x4) Phillips PH2 (x4) PH3 (x4) Pozidriv PZ2 (x4) PZ3 (x4)
Hex HX3 (x4) HX4 (x4) HX5 (x4) HX6 (x4) HX8 (x4) Torx T10 (x4) T15 (x4) T20 (x4) T25 (x4) T30 (x4)

1/4" • Accesorios • Accessories • Accessoires

75mm (x4) 150mm (x4) 509-009 (x2) 509-011 (x2)
 510-001 (x4) 510-002 (x4) Juegos Sets • Jeux 11 500-061 (x2) 501-061 (x2) 17 500-001 (x1)

3/8" • Llaves de Vaso • Sockets • Douilles

Hex 6 (x4) 7 (x4) 8 (x4) 9 (x4) 10 (x4) 11 (x4) 12 (x4) 13 (x4) 14 (x4) 15 (x4) 16 (x4)
Bihex 17 (x4) 18 (x4) 19 (x4) 20 (x4) 21 (x4) 22 (x4)

Torx E08 (x4) E10 (x4) E11 (x4) E12 (x4) E14 (x4) E16 (x4) E18 (x4)

3/8" • Llaves de Vaso con Punta • Socket Bits • Douilles-Embouts de Vissage

Recta Slot Plat 5,5 (x4) 6,5 (x4) 8 (x4) 10 (x4) Phillips PH1 (x4) PH2 (x4) PH3 (x4) Pozidriv PZ1 (x4) PZ2 (x4) PZ3 (x4)
Hex HX4 (x4) HX5 (x4) HX6 (x4) HX8 (x4) HX10 (x4) Torx T10 (x4) T15 (x4) T20 (x4) T25 (x4) T30 (x4) T40 (x4) T50 (x4)

3/8" • Accesorios • Accessories • Accessoires

75mm (x4) 100mm (x4) 524-009 (x2) 524-011 (x2) 524-012 (x2)
 525-001 (x4) 525-002 (x4) Juegos Sets • Jeux 12 516-061 (x2) 10 515-061 (x2) 17 516-001 (x1)

1/2" • Llaves de Vaso • Sockets • Douilles

Hex 8 (x4) 9 (x4) 10 (x4) 11 (x4) 12 (x4) 13 (x4) 14 (x4) 15 (x4) 16 (x3) 17 (x3) 18 (x3) 19 (x3)
Bihex 20 (x3) 21 (x2) 22 (x2) 23 (x2) 24 (x2) 25 (x2) 26 (x2) 27 (x2) 28 (x2) 29 (x2) 30 (x2) 32 (x2)

Torx E10 (x4) E11 (x4) E12 (x4) E14 (x4) E16 (x4) E18 (x4) E20 (x4) E24 (x4)

1/2" • Llaves de Vaso con Punta • Socket Bits • Douilles-Embouts de Vissage

Hex HX10 (x2) HX12 (x2) HX14 (x2) HX17 (x2) HX19 (x2) Phillips PH1 (x4) PH2 (x4) PH3 (x4) Pozidriv PZ1 (x4) PZ2 (x4) PZ3 (x4)
XZN 5 (x4) 6 (x4) 8 (x4) 10 (x4) 12 (x4) 14 (x4) 16 (x2) Torx T20 (x4) T25 (x4) T30 (x4) T40 (x2) T50 (x2) T60 (x2)

1/2" • Accesorios • Accessories • Accessoires

125mm (x4) 543-009 (x2) 543-011 (x2) 543-012 (x2) 543-019 (x2)
 544-001 (x3) 544-002 (x3) 13 531-061 (x2) 530-061 (x2) 14 531-001 (x1) 76 500-025 (x1)

Part N°

€

EXP16

6.911,74

1000 x 400 x 2200 mm

Implantaciones • Store Displays • Implantations

EXP

Implantación de Fontanería

Plumbing Store Display • Implantation de Plomberie



1000 x 400 x 2200 mm

• Llaves Stillson Profesionales • Professional Type Pipe Wrenches • Clés Stillson Professionnelles

	250mm (x2)		350mm (x2)		450mm (x2)		600mm (x1)		900mm (x1)
	250mm (x2)		350mm (x2)		450mm (x2)		600mm (x1)		900mm (x1)

• Alicates Serie Profesional • Profesional Series Pliers • Pincers Série Professionnelle

	160mm (x5)		160mm (x5)
-----------------------------------------------------------------------------------	----------------------	------------------------------------------------------------------------------------	----------------------

• Tenazas • Pincers • Tenailles

	265-250 (x4)		267-250 (x4)		268-250 (x4)		270-200 (x4)
	272-250 (x4)						

• Tenazas Grip • Locking Pliers • Pincers-Étaux

	275-250 (x2)		276-250 (x2)		274-250 (x2)		278-225 (x2)
-------------------------------------------------------------------------------------	------------------------	--------------------------------------------------------------------------------------	------------------------	---------------------------------------------------------------------------------------	------------------------	---------------------------------------------------------------------------------------	------------------------

• Cortatubos para PVC • PVC Pipe Cutters • Coupe-Tubes PVC

	665-45 (x3)		667-36 (x3)
-------------------------------------------------------------------------------------	-----------------------	--------------------------------------------------------------------------------------	-----------------------









• Cortatubos para Metal • Zip Action Tube Cutters • Coupe-Tubes pour le Métal

	675-03-28 (x3)		675-03-32 (x3)		675-03-41 (x3)		675-06-65 (x3)
	675-03-16 (x3)		676-10 (x3)		676-12 (x3)		676-15 (x3)
	676-22 (x3)		677-03-40 (x3)				

• Flexómetros • Measuring Tapes • Mètres Ruban

	775-05 (x4)		776-05 (x4)		777-05 (x4)		779-30 (x4)
-------------------------------------------------------------------------------------	-----------------------	--------------------------------------------------------------------------------------	-----------------------	---------------------------------------------------------------------------------------	-----------------------	---------------------------------------------------------------------------------------	-----------------------

• Cutters • Cutter Knives • Cutters

	790-011 (x4)		790-020 (x4)		789-001 (x4)		789-002 (x4)
	789-003 (x4)		789V-09 (x4)		789V-18 (x4)		789R-18 (x4)
	790-01-50 (x4)						

Part N°

€

EXP17

3.566,76

Terms and Conditions



• INTRODUCTION

The following Terms and Conditions apply from December 1st 2013 onwards, thus overriding any previously offered commercial Conditions, unless specifically agreed by writing between the Parties.

• PAYMENT TERMS

Terms of payment will be agreed on an individual basis with each Customer with the authorization of the Administrative and Financial Department.

Any breach of the agreed Conditions will generate an immediate cancellation of deliveries.

• INSURANCE

The goods are shipped under Customer responsibility. In the case that the Customer requires an additional insurance policy, it is understood that he will support this cost in full.

• CLAIMS

Customers must check all the Products upon their reception in order to ensure that the shipment complies with the order in terms of references, items and quantities. Any claim resulting from a discrepancy has to be submitted by the Customer within 8 days from reception. DOGHER TOOLS, S.A. reserves the right to refuse any claim that would not respect this procedure.

• RETURNING GOODS

DOGHER TOOLS, S.A. will only accept returned Products due to manufacturing fault or any other mistake strictly and directly attributable to DOGHER TOOLS, S.A., providing that the goods are proven faulty after being checked by our Quality Department. The Products will be returned at Customer cost and have to be sent together with the original invoice or packing list.

DOGHER TOOLS, S.A. must be immediately informed about any returned Product, directly or through our sales network. The Quality Department will check the Product and shortly issue a technical and quality report. In case that absolutely no fault is found, DOGHER TOOLS, S.A. will deduct 15% from the correspondent credit note to cover handling cost. In case that a manufacturing or quality default is found on the Product, it will be immediately replaced at manufacturer cost or a credit note will be issued.

• GUARANTEE

DOGHER TOOLS, S.A. guarantees all the Products available in its range against any material and manufacturing fault, but disclaims all responsibility in case of a misuse of the Product. In any case, the responsibility of DOGHER TOOLS, S.A. will be limited only to the reparation or replacement of the Product. The Customer will not be in any case entitled to any further compensation.

DOGHER TOOLS, S.A. reserves the right to modify its Products in terms of dimensions, materials or any technical features, without prior notice, whenever the Technical Department considers this modification as a technical improvement of the Product.

DOGHER TOOLS, S.A. will replace the Product only if there is a favourable report from the Quality Department and will only take into account the Goods that are returned according the established procedure.

DOGHER TOOLS, S.A. will not in any case be held responsible for any claim or will not admit any charge or penalty that results from delays in transport.

• MINIMUM ORDER TOTAL AMOUNT

Minimum order total amount is 60 € Net.

• PRICE LIST IN FORCE

DOGHER TOOLS, S.A. will apply the current price list and is not responsible for any misunderstanding originated from a misreading or interpretation of the Customer. All the prices are in Euros and are per unit, unless otherwise indicated.

• ENFORCEMENT

By accepting an order from DOGHER TOOLS, S.A. the Customer commits to comply with the present Terms and Conditions, unless otherwise agreed by written authorization from DOGHER TOOLS, S.A.

• TAXES

Orders are not subject to VAT.

• RETENTION OF TITLE

DOGHER TOOLS, S.A. orders are subject to a reservation of title clause (according to Art. 1506 of Spanish CC) until the payment in full of the corresponding invoice.

• COMPETENT JURISDICTION

The interpretation of the present Terms and Conditions as well as the settlement of any dispute that may arise from their application will be subject to the Spanish Law and brought before the Court of Bilbao. The Customer thereby accepts to renounce to his own jurisdiction.



• INTRODUCTION

Les conditions générales de vente entrent en vigueur à partir du 1er Décembre 2013. Il est entendu que toutes les ventes et livraisons effectuées par DOGHER TOOLS, S.A. à partir du 1er Décembre 2013 sont soumises à ces conditions générales, sauf disposition expresse contraire écrite et signée par les parties contractantes, qui prévaudraient sur les conditions générales.

• MODALITÉS DE RÈGLEMENT

· Les termes de paiement sont accordés individuellement avec le client sous réserve de l'accord préalable de la Direction Administrative et Financière.
· Le défaut de paiement impliquera l'arrêt immédiat des livraisons.

• ASSURANCE

Les marchandises voyagent toujours au seul risque de l'acheteur, étant toujours à sa charge la prime à payer si le client souhaite assurer la marchandise.

• RÉCLAMATIONS

Les clients sont tenus d'examiner les produits livrés à leur réception, pour vérifier la conformité avec la commande quant à la ou les références, et le nombre d'unités livrées. En cas de non-conformité ou de différences constatées à la réception du matériel, seront acceptées les réclamations effectuées sous 8 jours après réception. Aucun retour ne sera accepté sans cette communication à DOGHER TOOLS, S.A., dans les délais indiqués.

• RETOURS

Seront acceptés uniquement les retours pour défaut de fabrication ou erreurs directement attribuables à DOGHER TOOLS, S.A., et après approbation du Département Qualité de DOGHER TOOLS, S.A. Les retours seront effectués à ports payés et seront accompagnés de la facture originale et du bon de livraison. L'expédition sera effectuée par nos moyens habituels de transport.

Tout retour de matériel doit être immédiatement communiqué à DOGHER TOOLS, S.A., SA directement ou par l'intermédiaire du Représentant, les frais de port étant à la charge du client. À la réception de l'outil, notre Département Qualité effectuera les contrôles nécessaires et pertinents, et émettra un rapport. Dans le cas où l'outil ne présenterait aucun défaut imputable à sa qualité, et s'il n'y avait pas d'erreurs imputables à DOGHER TOOLS, S.A., 15% du prix d'achat seront déduits en concepts de manipulation et d'inspection.

• GARANTIES

DOGHER TOOLS, S.A., SA, garantit tous les outils de son programme de vente contre tout défaut de matière et de fabrication, sans se rendre en aucune manière responsable de l'utilisation inadéquate des dits outils. Dans tous les cas, la responsabilité de DOGHER TOOLS, S.A. se limite exclusivement à la réparation ou au remplacement de l'outil défectueux à hauteur de la valeur maximale de l'outil fourni, ceci n'engageant aucun avoir ni pénalité pour aucun autre concept.

DOGHER TOOLS, S.A. se réserve le droit de modifier, sans préavis, les dimensions, nuances d'acier, et en général toute caractéristique technique de ses produits, dès que le Service Technique estime que ce changement suppose une amélioration du produit.

DOGHER TOOLS, S.A. ne remplacera aucun outil sans un rapport favorable de son Département Qualité, et dans tous les cas en respectant les conditions de fonctionnement décrites dans la section Retours.

DOGHER TOOLS, S.A. ne pourra accepter aucune réclamation ou pénalité de quelque nature en cas de retards éventuels dans la livraison d'une commande.

• TRANSPORT

· Les commandes seront envoyées Franco de port en France Métropolitaine à partir d'un montant de 250 € nets.
· Pour les commandes inférieures à 250 € nets, les frais d'envoi seront à la charge du client (ils seront ajoutés au montant des outils envoyés, en fonction de ce qui aura été accordé avec le client, et en utilisant toujours les moyens de transports pour lesquels il existe un accord avec DOGHER TOOLS, S.A.).
· DOGHER TOOLS, S.A. se réserve le droit d'utiliser le moyen de transport le plus adéquat en fonction des caractéristiques, de la destination, du poids et du volume de l'envoi.

• MINIMUM DE COMMANDE

Le montant minimum de commande est de 60 € net.

• TARIF EN VIGUEUR

DOGHER TOOLS, S.A. appliquera les conditions et prix indiqués dans le tarif en vigueur, ne pouvant être rendue responsable d'interprétations externes à son contenu. Tous les prix indiqués dans le tarif sont unitaires sauf indication contraire.

• APPLICATION

L'acceptation de la marchandise livrée par DOGHER TOOLS, S.A. sans refus immédiat par l'acheteur, implique l'acceptation de ces conditions générales de vente. Leur modification sera valide seulement s'il existe un accord écrit de la part de DOGHER TOOLS, S.A.

• T.V.A.

Les commandes ne sont pas sujettes à la TVA.

• RESERVE DE PROPRIÉTÉ

Les produits vendus par DOGHER TOOLS, S.A. restent de sa propriété tant que le règlement intégral des factures correspondant n'a pas été effectué.

• JURIDICTION COMPÉTENTE

Pour tout litige concernant l'interprétation de ces conditions, ou relatif à leur non respect par l'une des parties, celles-ci se soumettent à la juridiction des tribunaux de Bilbao, renonçant à celle qui pourrait être d'éventuelle application.

Condiciones Generales de Venta



• INTRODUCCIÓN

Las presentes condiciones generales de venta estarán en vigor desde el 1 de Diciembre de 2013, entendiéndose que todas las ventas y entregas efectuadas por DOGHER TOOLS, S.A. desde el 1 de Diciembre de 2013 estarán sometidas a las presentes Condiciones Generales de Venta, salvo pacto expreso por escrito firmado por las partes contratantes, en cuyo caso, dichos pactos particulares prevalecerán.

• CONDICIONES DE PAGO

· La forma de pago será acordada individualmente con cada cliente, previa autorización del Departamento Administrativo-Financiero de DOGHER TOOLS, S.A., y adecuándose como máximo a los límites establecidos en la Ley 15/2010 del 5 de Julio de 2010.

· El incumplimiento de las condiciones de pago acordadas supondrá el corte del suministro de forma inmediata.

• VENCIMIENTOS FIJOS

En caso de fechas fijas de pago que rebasen los plazos previamente estipulados, giraremos a la fecha fijada inmediatamente anterior, según corresponda, no pudiendo superarse en ningún caso los límites establecidos en la Ley 15/2010 del 5 de Julio de 2010.

• SEGURO

Las mercancías viajarán siempre por exclusiva cuenta y riesgo del comprador, siendo siempre a cargo del mismo la prima del seguro que se realice, en los casos que el cliente desee asegurarlas.

• RECLAMACIONES

Los clientes tienen la obligación de examinar los productos servidos a su recepción, a fin de comprobar su conformidad con el pedido en cuanto a la referencia o referencias servidas y el número de unidades entregadas. En discrepancias por diferencias observadas en la recepción del material, se atenderán y evaluarán todas aquellas reclamaciones que se planteen dentro de los 8 días siguientes a su recepción, no aceptándose ninguna devolución sin la debida comunicación previa a DOGHER TOOLS, S.A. en el plazo establecido.

• DEVOLUCIONES

Únicamente se aceptarán devoluciones por defecto de fabricación o error directamente atribuible a DOGHER TOOLS, S.A., y previa autorización del Departamento de Calidad de DOGHER TOOLS, S.A. Las devoluciones serán a portes pagados, deberán acompañar la factura y albarán original, y el envío se deberá realizar siempre por los medios de transporte habituales que DOGHER TOOLS, S.A. utiliza.

Cualquier devolución de material deberá ser comunicada de forma inmediata a DOGHER TOOLS, S.A. directamente o por mediación del Representante, corriendo los gastos de transporte por cuenta del cliente. Una vez recibida la herramienta devuelta, nuestro Departamento de Calidad realizará las comprobaciones e inspecciones pertinentes, emitiendo el correspondiente informe. En el caso de que la herramienta no presente ningún defecto atribuible a la calidad de la misma y no existan errores atribuibles a DOGHER TOOLS, S.A., se deducirá un 15% del valor de compra en concepto de manipulación e inspección de calidad.

• GARANTÍAS

DOGHER TOOLS, S.A. garantiza todas las herramientas que componen su programa de ventas contra cualquier defecto de fabricación y materiales, sin responsabilizarse bajo ningún concepto de la utilización inadecuada de las mismas. En cualquier caso, la responsabilidad de DOGHER TOOLS, S.A. estará limitada única y exclusivamente a la reparación o sustitución de la herramienta defectuosa con el límite máximo del valor de la herramienta suministrada, no comprometiéndose abonos ni penalizaciones por ningún otro concepto.

DOGHER TOOLS, S.A. se reserva el derecho a modificar, sin previo aviso, las dimensiones, calidades de materiales y en general cualquier característica técnica de sus productos, siempre que el Departamento Técnico considere que dicha variación supone una mejora técnica del producto.

DOGHER TOOLS, S.A. no sustituirá ninguna herramienta sin el informe técnico favorable de nuestro Departamento de Calidad, respetando

en todo momento las condiciones de funcionamiento expuestas en el apartado de Devoluciones.

DOGHER TOOLS, S.A. no admitirá reclamaciones o penalizaciones de ninguna naturaleza en caso de que se produjeran eventuales retrasos en la entrega de un pedido.

• PORTES

ENVÍOS A PENÍNSULA Y BALEARES:

· Se suministrarán a portes pagados aquellas expediciones cuyo importe sea superior a 150 € netos.

· Para pedidos inferiores a 150 € netos por expedición, los portes irán por cuenta del cliente (portes debidos o cargados en factura según acuerdo con el cliente y siempre utilizando los medios de transporte con los que DOGHER TOOLS, S.A. mantiene algún tipo de convenio).

· DOGHER TOOLS, S.A. se reserva el derecho a utilizar el medio de transporte más adecuado según los acuerdos que pueda mantener con características, destino, peso y volumen del envío.

ENVÍOS A PORTUGAL:

· Se suministrarán a portes pagados aquellas expediciones cuyo importe sea superior a 200 € netos.

· Para pedidos inferiores a 200 € netos por expedición los portes irán por cuenta del cliente (portes debidos o cargados en factura según acuerdo con el cliente y siempre utilizando los medios de transporte con los que DOGHER TOOLS, S.A. mantiene algún tipo de convenio).

· DOGHER TOOLS, S.A. se reserva el derecho a utilizar el medio de transporte más adecuado según los acuerdos que pueda mantener con características, destino, peso y volumen del envío.

ENVÍOS A CANARIAS, CEUTA, MELILLA Y ANDORRA:

· Se suministrarán a portes pagados aquellas expediciones cuyo importe sea superior a 300 € netos.

· Para pedidos inferiores a 300 € netos por expedición, los portes irán por cuenta del cliente (portes debidos o cargados en factura según acuerdo con el cliente y siempre utilizando los medios de transporte con los que DOGHER TOOLS, S.A. mantiene algún tipo de convenio).

· DOGHER TOOLS, S.A. se reserva el derecho a utilizar el medio de transporte más adecuado según los acuerdos que pueda mantener con características, destino, peso y volumen del envío.

• IMPORTE MÍNIMO POR PEDIDO

Queda establecido como pedido mínimo la cantidad de 40 € netos.

• TARIFA EN VIGOR

DOGHER TOOLS, S.A. aplicará condiciones y precios estipulados en la tarifa en vigor existente en cada momento, no responsabilizándose de interpretaciones ajenas al contenido de la misma. Todos los precios expresados en la tarifa son unitarios, salvo que se indique lo contrario.

• CONDICIONALIDAD

La aceptación de las mercancías suministradas por DOGHER TOOLS, S.A., sin el rechazo inmediato por parte del comprador, supone la aprobación de estas condiciones generales de venta, y su modificación sólo tendrá validez si consta por escrito la conformidad de DOGHER TOOLS, S.A.

• I.V.A.

Los precios están sujetos al Impuesto Sobre el Valor Añadido que esté en vigor en cada momento, siendo éste por cuenta del cliente.

• RESERVA DE DOMINIO

Las ventas efectuadas por DOGHER TOOLS, S.A. se consideran siempre bajo la condición de Reserva de Dominio, según el artículo 1.506 de C.C., hasta que no se haya hecho efectivo íntegramente el pago de todo lo adeudado.

• JURISDICCIÓN COMPETENTE

Para cualquier discrepancia acerca de la interpretación de estas condiciones, o litigio por razón de incumplimiento por cualquiera de las partes, se someten ambas al fuero de los Juzgados Tribunales de Bilbao, con renuncia al que pudiera corresponderles.



DOGHER TOOLS, S.A.
Matxingoia N°6 · 48220 Abadiano (Spain)
Tel.: +34 946216145 · Fax: +34 946216147
comercial@dogher.com · export@dogher.com
www.dogher.com



8 433711 064719